

MSLZ01-25061A

MSL

MULTIPLE LIGHT BEAM SAFETY DEVICES

SICK
Sensor Intelligence.

Ordering information

Type	Part no.
MSLZ01-25061A	1015671

Other models and accessories → www.sick.com/MSL

Detailed technical data

Safety-related parameters

Type	Type 4 (IEC 61496)
Safe state in the event of a fault	At least one OSSD is in the OFF state.

Features

System part	Sender/receiver in one housing
Scanning range	0 m ... 7.5 m
Number of beams	1
Beam separation	500 mm
Response time	≤ 15 ms

Interfaces

System connection	Connection type	Plug-in terminal chamber
	Cable length	70 m
Fieldbus, industrial network	Integration via Flexi Soft safety controller	CANopen, DeviceNet™, EtherCAT®, EtherNet/IP™, Modbus TCP, PROFIBUS DP, PROFINET ¹⁾

¹⁾ For further information on Flexi Soft, please see sens:Control – safe control solutions product catalog or -> www.sick.com/FlexiSoft.

Electrical data

Protection class	I
Supply voltage V_s	24 V DC (19.2 V DC ... 28.8 V DC) ¹⁾
Residual ripple	≤ 2.5 V _{pp} ²⁾
Power consumption	< 17 W
Switching outputs	2 PNP semiconductors, short-circuit protected, cross-circuit monitored
Output current	≤ 200 mA

¹⁾ The external voltage supply must be capable of buffering brief mains voltage failures of 20 ms as specified in EN 60204-1. Suitable power supplies are available as accessories from SICK.

²⁾ , The voltage must not exceed or fall below the limit values.

Mechanical data

Dimensions	52 mm x 55 mm x 842 mm
Weight	3.085 kg

Ambient data

Enclosure rating	IP65
Ambient operating temperature	0 °C ... +55 °C
Storage temperature	-25 °C ... +70 °C

Other information

Wave length	880 nm
--------------------	--------

Classifications

ECl@ss 5.0	27272703
ECl@ss 5.1.4	27272703
ECl@ss 6.0	27272703
ECl@ss 6.2	27272703
ECl@ss 7.0	27272703
ECl@ss 8.0	27272703
ECl@ss 8.1	27272703
ECl@ss 9.0	27272703
ETIM 5.0	EC001832
ETIM 6.0	EC001832
UNSPSC 16.0901	46171620

Dimensional drawing (Dimensions in mm (inch))

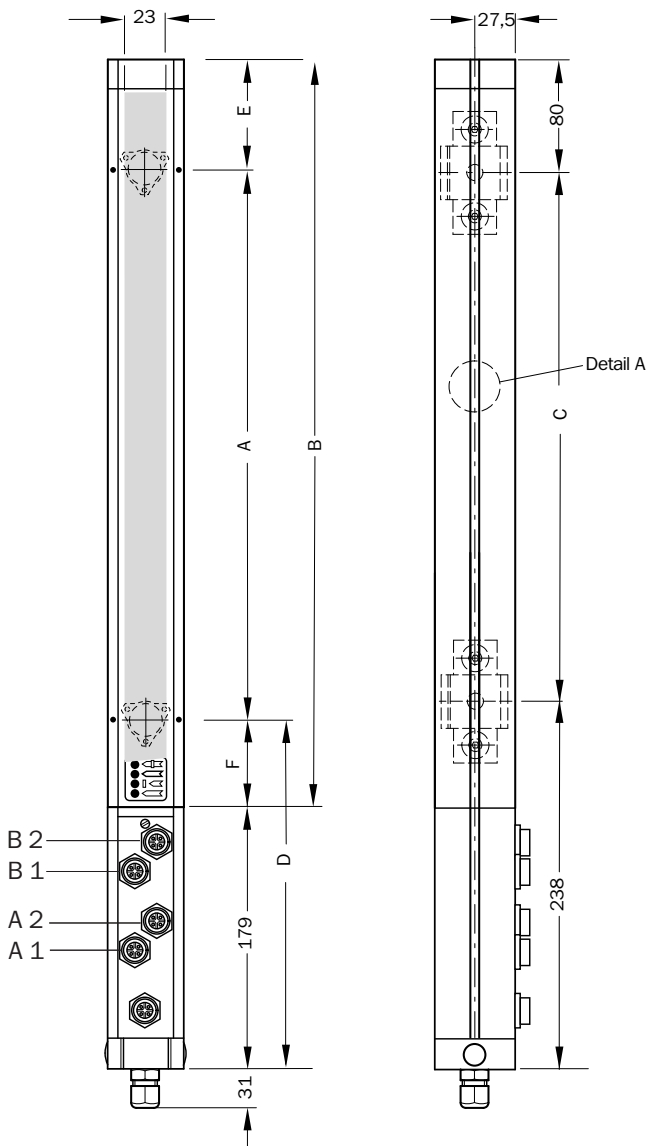
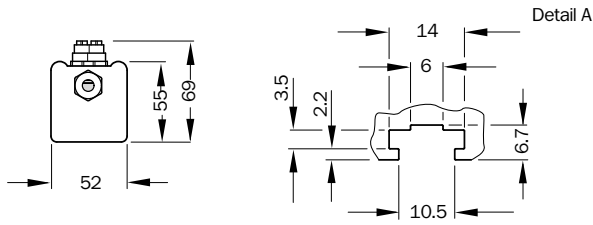

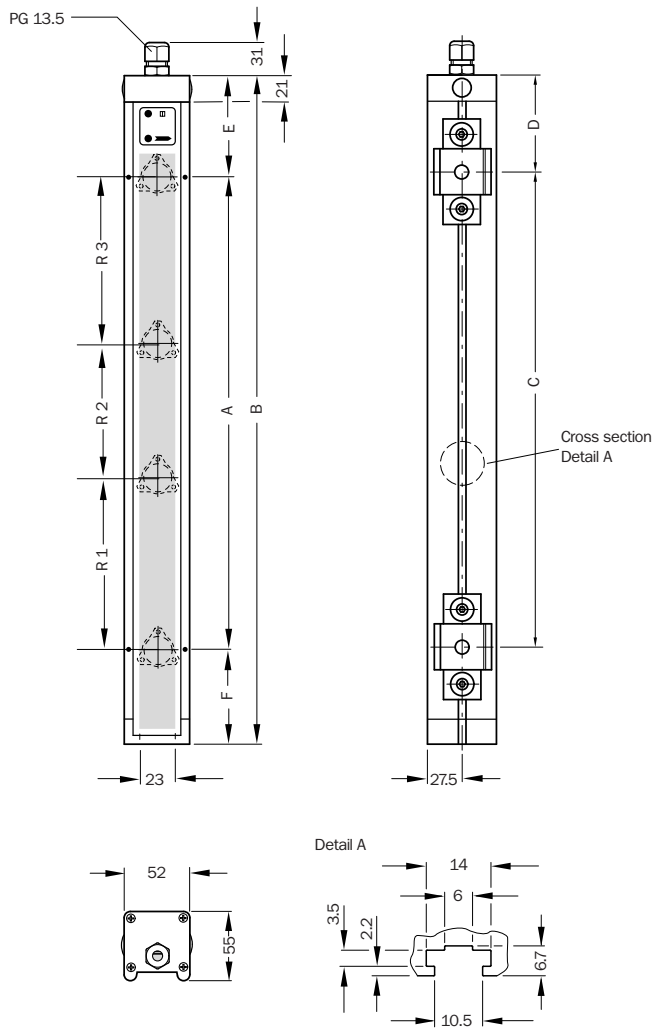

Connection diagram

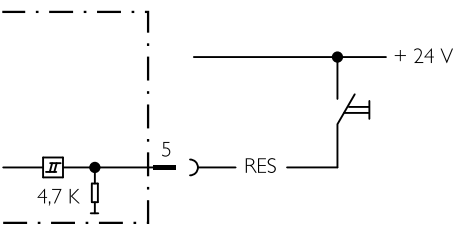
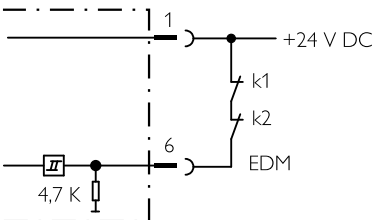
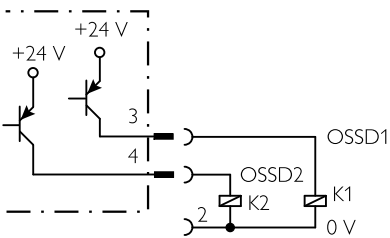
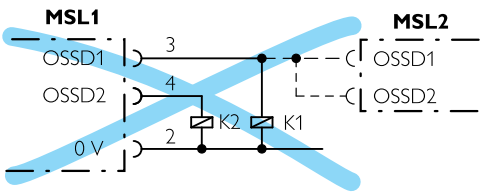
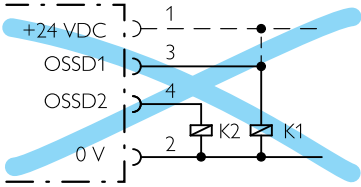
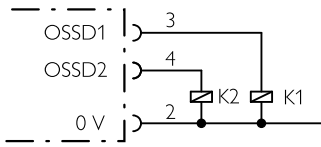

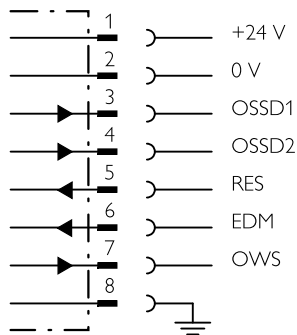
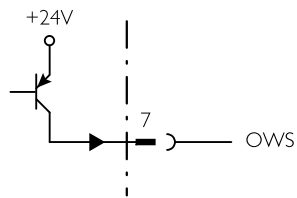
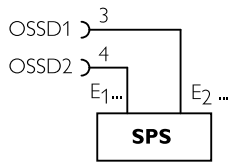
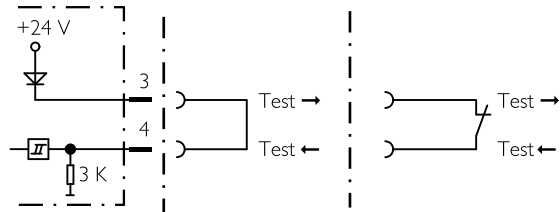
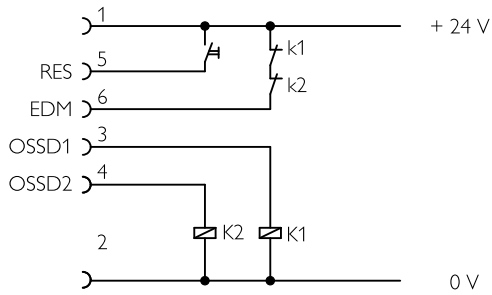

RW 70 m

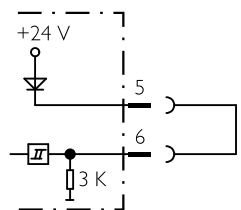

MSLZ01-25061A | MSL

MULTIPLE LIGHT BEAM SAFETY DEVICES

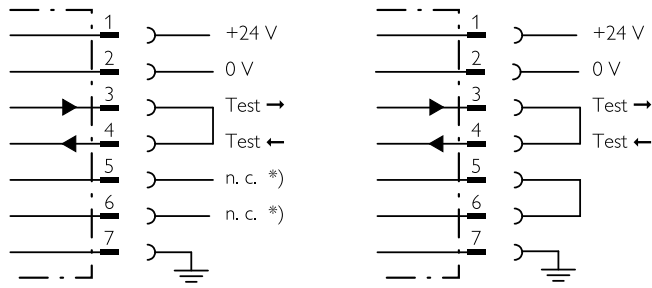

SICK AT A GLANCE

SICK is one of the leading manufacturers of intelligent sensors and sensor solutions for industrial applications. A unique range of products and services creates the perfect basis for controlling processes securely and efficiently, protecting individuals from accidents and preventing damage to the environment.

We have extensive experience in a wide range of industries and understand their processes and requirements. With intelligent sensors, we can deliver exactly what our customers need. In application centers in Europe, Asia and North America, system solutions are tested and optimized in accordance with customer specifications. All this makes us a reliable supplier and development partner.

Comprehensive services complete our offering: SICK LifeTime Services provide support throughout the machine life cycle and ensure safety and productivity.

For us, that is “Sensor Intelligence.”

WORLDWIDE PRESENCE:

Contacts and other locations –www.sick.com