

## **HARDWARE MANUAL [CONNECTION]**

GOT-F900 SERIES GRAPHIC OPERATION TERMINAL

### **Covered models**

F920GOT-K  
F920GOT-BBD-K-E  
F920GOT-BBD5-K-E

F930GOT(-K)  
F930GOT-BWD-E  
F930GOT-BBD-K-E

F940GOT  
F940WGOT-TWD-E  
F940GOT-SWD-E/-LWD-E

Handy GOT  
F940GOT-SBD-H-E/-LBD-H-E  
F943GOT-SBD-H-E/-LBD-H-E  
F940GOT-SBD-RH-E/-LBD-RH-E  
F943GOT-SBD-RH/-E-LBD-RH-E

### **Screen creation software**

GT Designer2  
(SW\*D5C-GTD2-E)

GT Designer  
(SW\*D5C-GOTR-PACKE)

FX-PCS-DU/WIN-E

***GOT-F900***

## Foreword

- This manual contains text, diagrams and explanations which will guide the reader in the correct installation and operation of the GOT-F900 SERIES GRAPHIC OPERATION TERMINAL. It should be read and understood before attempting to install or use the unit.
- Further information can be found in the GOT-F900 Operation Manual, F920GOT-K Installation Manual, F930GOT Installation Manual, F930GOT-K Installation Manual, F940GOT Installation Manual, F940WGOT Installation Manual.
- If in doubt at any stage of the installation of GOT-F900 SERIES GRAPHIC OPERATION TERMINAL always consult a professional electrical engineer who is qualified and trained to the local and national standards which apply to the installation site.
- If in doubt about the operation or use of GOT-F900 SERIES GRAPHIC OPERATION TERMINAL please consult the nearest Mitsubishi Electric distributor.
- This manual is subject to change without notice.

# GOT-F900 SERIES GRAPHIC OPERATION TERMINAL

## HARDWARE MANUAL (CONNECTION)

Manual number : JY992D94801

Manual revision : F

Date : September 2008

This manual confers no industrial property rights or any rights of any other kind, nor does it confer any patent licenses. Mitsubishi Electric Corporation cannot be held responsible for any problems involving industrial property rights which may occur as a result of using the contents noted in this manual.







## Guidelines for the Safety of the User and Protection of the Graphic operation terminal GOT-F900

This manual provides information for the use of the Graphic operation terminal GOT-F900. The manual has been written to be used by trained and competent personnel. The definition of such a person or persons is as follows;

- a) Any engineer who is responsible for the planning, design and construction of automatic equipment using the product associated with this manual should be of a competent nature, trained and qualified to the local and national standards required to fulfill that role. These engineers should be fully aware of all aspects of safety with regards to automated equipment.
- b) Any commissioning or service engineer must be of a competent nature, trained and qualified to the local and national standards required to fulfill that job. These engineers should also be trained in the use and maintenance of the completed product. This includes being completely familiar with all associated documentation for the said product. All maintenance should be carried out in accordance with established safety practices.
- c) All operators of the completed equipment should be trained to use that product in a safe and coordinated manner in compliance to established safety practices. The operators should also be familiar with documentation which is connected with the actual operation of the completed equipment.

**Note :** Note: the term 'completed equipment' refers to a third party constructed device which contains or uses the product associated with this manual.

### Notes on the Symbols Used in this Manual

At various times through out this manual certain symbols will be used to highlight points of information which are intended to ensure the users personal safety and protect the integrity of equipment. Whenever any of the following symbols are encountered its associated note must be read and understood. Each of the symbols used will now be listed with a brief description of its meaning.

#### Hardware Warnings



- 1) Indicates that the identified danger **WILL** cause physical and property damage.



- 2) Indicates that the identified danger could **POSSIBLY** cause physical and property damage.



- 3) Indicates a point of further interest or further explanation.

#### Software Warnings



- 4) Indicates special care must be taken when using this element of software.



- 5) Indicates a special point which the user of the associate software element should be aware of.



- 6) Indicates a point of interest or further explanation.

- Under no circumstances will Mitsubishi Electric be liable responsible for any consequential damage that may arise as a result of the installation or use of this equipment.
- All examples and diagrams shown in this manual are intended only as an aid to understanding the text, not to guarantee operation. Mitsubishi Electric will accept no responsibility for actual use of the product based on these illustrative examples.
- Please contact a Mitsubishi distributor for more information concerning applications in life critical situations or high reliability.

### **Note to user**

This manual describes the connection procedure to connect the graphic operation terminal (GOT-F900 Series) to a MELSEC FX/A/QnA/Q Series PLC, PLC by another company, printer, bar code reader, etc.

Please read this manual before using the GOT-F900 Series, understand sufficiently the use of the product, then use correctly the product.

For the contents related to the specifications and the operations such as the display function of the product, refer to the USER'S MANUAL of each product offered separately.

For the details about screen creation for GOT-F900, refer to the OPERATION MANUAL attached to the screen creation software.

Make sure that this manual is delivered to the end user.

### **Trademarks and registered trademarks**

"Microsoft", "Windows", "Windows 98", "Windows NT", "Windows 2000", "Windows XP", "Windows Millennium Edition", "MS-DOS", "MS" and "Windows" logos are registered trademarks of Microsoft Corporation USA in the USA and other countries.

"ESC/P" is a registered trademark of SEIKO EPSON CORPORATION.

"FLEX-PC N Series" is a registered trademark of Fuji Electric Co., Ltd.

"SYSMAC C Series", "CS1 Series", "CJ1 Series" and "SYSMAC $\alpha$  Series" are registered trademarks of OMRON Corporation.

"SLC500" and "Micro Logix Series" are registered trademarks of Allen-Bradley Co., Inc. in the USA and other countries.

Each of other company names and product names is a trademark or registered trademark of each company.

"Windows 98" is used as abbreviation of the Microsoft® Windows® 98 operating system.

"Windows Millennium Edition" is used as abbreviation of the Microsoft® Windows® Millennium Edition operating system.

"Windows NT 4.0" is used as abbreviation of the Microsoft® Windows NT® 4.0 Workstation operating system.

"Windows 2000" is used as abbreviation of the Microsoft® Windows® 2000 operating system.

"Windows XP" is used as abbreviation of the Microsoft® Windows® XP professional/Home Edition.



Guidelines .....	V
1. Introduction .....	1-1
1.1 Rank and Use Method of This Manual .....	1-1
1.1.1 Classification of Manuals in Accordance with Purpose .....	1-3
1.2 Abbreviations, Generic Names and Terms Used in This Manual .....	1-7
1.2.1 Types and Names of GOT-F900 Series .....	1-7
1.2.2 Information Offered by Model Name .....	1-9
1.2.3 In-built Fonts of Graphic Operation Terminal (Japanese/Overseas product) .....	1-10
1.2.4 Abbreviation List .....	1-11
2. Outline .....	2-1
2.1 Connection Type Supported by GOT-F900 .....	2-1
2.1.1 GOT type list and index .....	2-1
2.1.2 Connection type list and index .....	2-2
2.2 Outline of Connection Types .....	2-3
2.2.1 PLC by Mitsubishi .....	2-3
2.2.2 PLC by Other Companies .....	2-7
2.2.3 Others .....	2-9
3. Specifications .....	3-1
3.1 OS Version and Correspondence to Connected Equipment of GOT-F900 .....	3-1
3.1.1 How to Confirm OS Version of GOT-F900 .....	3-1
3.1.2 PLC, Positioning unit, Inverter Manufactured by Mitsubishi .....	3-2
3.1.3 PLC Manufactured by Other Companies .....	3-5
3.1.4 Others .....	3-8
3.2 Version of Screen Creation Software and Correspondence to GOT-F900 .....	3-9
3.2.1 How to Conform Version of Screen Creation Software .....	3-10
3.2.2 Screen Creation Software Version Corresponding to GOT-F900 Series .....	3-12
3.2.3 Screen Creation Software Corresponding to Each Connected Equipment .....	3-13
3.3 Device Names Which can be Monitored .....	3-15
3.3.1 Devices in GOT-F900 .....	3-15
3.3.2 PLC by Mitsubishi .....	3-16
3.3.3 PLC Units Manufactured by Other Companies .....	3-21
3.4 Hardware Specifications .....	3-30
3.5 Display specifications .....	3-36
4. Installation and Wiring of F920GOT-K/F930GOT(-K)/F940(W)GOT .....	4-1
4.1 Outline of Connection .....	4-4
4.2 Name of Each Part .....	4-5
4.2.1 Front Panel .....	4-5
4.2.2 Rear Panel .....	4-5
4.2.3 Function of Ports .....	4-6
4.3 Outside Dimensions and Panel Face Processing .....	4-8
4.3.1 Panel Cut Dimension .....	4-8
4.4 Installation .....	4-9
4.4.1 Caution on installation .....	4-9
4.4.2 Inner dimension of the panel required for installation .....	4-10
4.4.3 Installation procedure .....	4-13
4.5 Connector Pin Layout and Signal Name (Excluding the 5 V type F920GOT-K) .....	4-14
4.6 Outline of Internal Wiring .....	4-15
4.7 Wiring for 24V DC and 5V DC Power Supply and Class D Grounding .....	4-16
4.8 Handling of Function Keys (F1 to F8) (F920GOT-K and F930GOT-K) .....	4-19
4.8.1 Use of function keys .....	4-20
4.8.2 Preparation of Function Key Name Sheet (Available in the F930GOT-K) .....	4-21
4.8.3 Cautions on use .....	4-22
4.8.4 Label pattern (F930GOT-K) .....	4-23
4.9 Setting of Connected Equipment for GOT .....	4-24
4.10 Caution on Use .....	4-32

5. Installation and Wiring of Handy GOT .....	5-1
5.1 Outline of Connection .....	5-5
5.1.1 Handy GOT (Excluding RH model) .....	5-6
5.1.2 Handy GOT (RH model) .....	5-8
5.2 Name of Each Part .....	5-10
5.2.1 Front Panel .....	5-10
5.2.2 Rear Panel and Connectors .....	5-11
5.3 Outside Dimensions and Installation .....	5-12
5.3.1 Outside Dimensions .....	5-12
5.3.2 Installation .....	5-14
5.4 Selection and Installation of External Cable .....	5-16
5.4.1 Handy GOT (Excluding RH model) .....	5-16
5.4.2 Wiring between Handy GOT (RH model) operation switches and connected equipment .....	5-18
5.4.3 Installation of External Cable .....	5-21
5.5 Processing Panel Face of Control Box or Cabinet .....	5-23
5.5.1 Selection of relay cable .....	5-23
5.5.2 Cautions on preparing cables .....	5-24
5.5.3 Appearance shape of Relay Cable .....	5-25
5.5.4 Panel Cut Dimension for Relay Cable .....	5-31
5.5.5 Panel Cut Dimension for F9GT-HCNB .....	5-31
5.5.6 Specification change of the external/relay cable .....	5-32
5.6 Pin Layout and Signal Allocation of Connector for Serial Communication and Operation Switches .....	5-34
5.6.1 Cautions on preparing cables .....	5-34
5.6.2 F9GT-HCABo-oM/F9GT-HCAB1-oM External Cable .....	5-34
5.6.3 F9GT-RHCAB-oM External Cable .....	5-35
5.7 Outline of Internal Wiring .....	5-36
5.8 Wiring for 24V DC Power Supply and Class D Grounding .....	5-38
5.9 Wiring and Handling of Operation Switches SW1 to SW4 .....	5-40
5.9.1 Handling of operation switches .....	5-40
5.9.2 Preparation of Operation Switch Name Sheet .....	5-42
5.10 Wiring and Handling of Emergency Stop Switch (ES1) .....	5-44
5.10.1 Cautions on preparing cables .....	5-44
5.10.2 Connection figure of cable .....	5-44
5.11 Handling of grip switch (excluding RH model) .....	5-46
5.11.1 Function of Grip Switch .....	5-46
5.11.2 Setting in main unit and screen creation software .....	5-46
5.11.3 Grip switch operation specifications .....	5-47
5.11.4 Communication with connected equipment (grip switch ON/OFF signal) .....	5-50
5.12 Handling of grip switch (RH model only) .....	5-52
5.12.1 Cautions on preparing cables .....	5-52
5.12.2 Wiring of Grip Switch .....	5-52
5.12.3 Setting of Grip Switch LED .....	5-53
5.12.4 LED Action .....	5-53
5.13 Handling of Keylock Switch (RH model only) .....	5-54
5.14 Setting of Connected Equipment for GOT .....	5-55
5.15 Connection Diagram of Handy GOT Operation Switches and Power Supply ...	5-61
5.15.1 Cautions on preparing cables .....	5-61
5.15.2 The connection figure of cable .....	5-61
5.16 Connector Conversion Box F9GT-HCNB .....	5-63
5.16.1 Outline of Product .....	5-63
5.16.2 Name of Each Part .....	5-63
5.16.3 Specifications .....	5-64
5.16.4 Installation .....	5-65
5.16.5 F9GT-HCNB Conversion Box .....	5-67

5.17 Diagnostic .....	5-68
5.17.1 F940 Handy GOT (F94*GOT-*BD-H-E) .....	5-68
5.17.2 F940GOT Handy (F94*GOT-*BD-RH-E).....	5-70
5.18 How to Read Manual for Handy GOT RH Model.....	5-72
<b>6. Connection of Peripheral Equipment</b>	
(Screen data transfer/Sequence program transfer and monitor) .....	6-1
6.1 Outline of Connection .....	6-1
6.2 Connection to Personal Computer .....	6-3
6.2.1 Screen Data Transfer .....	6-3
6.2.2 Sequence Program Transfer (two-port interface function built).....	6-4
6.2.3 Cable Connection Procedure .....	6-5
6.3 Connection of F943 Handy GOT (for PLC) and Personal Computer.....	6-7
6.3.1 Outline .....	6-7
6.3.2 Configuration to transfer screen data using PLC connector.....	6-7
6.3.3 Changeover of Connection between PLC and Personal Computer .....	6-8
6.4 Caution on Use of Peripheral Equipment .....	6-9
6.4.1 Caution when connecting the GOT and PLC via RS-232C port (Only in case of the F920GOT-K, F930GOT, F930GOT-K, or F940GOT) .....	6-9
6.4.2 Caution when transferring screen data to the F920GOT-K (5V type) .....	6-10
6.4.3 Cautions on connection to FX3U/FX3UC Series PLC .....	6-11
6.5 Cable Diagram.....	6-12
6.5.1 Cautions on preparing cables.....	6-12
6.5.2 Cable for Personal Computer .....	6-12
6.6 Troubleshooting.....	6-13
<b>7. Connection of Two or More GOT Units.....</b>	<b>7-1</b>
7.1 System Condition .....	7-1
7.2 Connection Configuration for Two or More GOT Units.....	7-2
7.2.1 Configuration When First GOT Unit is Connected through RS-422 .....	7-2
7.2.2 When First GOT Unit is Connected through RS-232C .....	7-4
7.2.3 When Connection is Changed from RS-422 to RS-232C.....	7-6
7.3 Rules in Configuration .....	7-7
7.3.1 Connection Method .....	7-7
7.3.2 Communication Port Number Table .....	7-8
7.3.3 Connection Concept in Each Model Name .....	7-8
7.4 Connection of Four or More Display Units.....	7-9
7.5 Cautions on Connecting Two or More GOT Units .....	7-11
7.5.1 Power ON Sequence.....	7-11
7.5.2 Communication speed between GOT units.....	7-12
7.5.3 Transfer of sequence program and use of monitor .....	7-12
7.5.4 Cautions on use of F940WGOT .....	7-13
7.5.5 Cautions on setting the screen creation software of GOT-F900 .....	7-13
7.6 Setting of Connected Equipment for GOT .....	7-14
7.6.1 Connection Type (RS-422/RS-232C setting) .....	7-14
7.6.2 Station Number Setting .....	7-14
7.6.3 Setting Procedure.....	7-15
7.7 Cable Diagram.....	7-22
7.7.1 Cautions on preparing cables.....	7-22
7.7.2 Cable diagram .....	7-22
7.8 Troubleshooting.....	7-26

8. Connection of MELSEC-F FX Series PLC .....	8-1
8.1 System Condition .....	8-1
8.2 System Configuration .....	8-2
8.2.1 Applicable model .....	8-2
8.2.2 Configuration for CPU Direct Connection (RS-422) .....	8-3
8.2.3 Configuration for CPU Direct Connection (RS-232C) .....	8-5
8.3 Cautions on Use of MELSEC-F FX Series .....	8-7
8.3.1 Device specification .....	8-7
8.3.2 Devices which can be monitored .....	8-7
8.3.3 When GOT-F900 is connected to optional port .....	8-7
8.3.4 Restrictions in connecting two or more F920GOT-K (5V type) units to FX Series PLC .....	8-10
8.3.5 Connection to FX3U/FX3UC Series PLC .....	8-11
8.4 Setting of Connected Equipment for GOT .....	8-12
8.5 Cable Diagram .....	8-19
8.5.1 Cautions on preparing cables .....	8-19
8.5.2 Cable diagram .....	8-19
8.6 Troubleshooting .....	8-23
9. Connection of MELSEC-A Series PLC .....	9-1
9.1 System Condition .....	9-2
9.2 System Configuration .....	9-3
9.2.1 Applicable model .....	9-3
9.2.2 Configuration for Direct Connection (RS-422) .....	9-4
9.2.3 Configuration for A Computer Link Connection (RS-422) .....	9-6
9.2.4 Configuration for A Computer Link Connection (RS-232C) .....	9-8
9.3 Setting in A Computer Link Connection .....	9-9
9.3.1 Communication Setting Specifications .....	9-9
9.3.2 Setting of CD Signal Control (only in RS-232C connection) .....	9-10
9.3.3 Setting Examples .....	9-11
9.3.4 Used Connectors and Connector Covers .....	9-14
9.3.5 Cable Specifications and Length .....	9-14
9.4 Caution on Use of MELSEC-A Series PLC .....	9-15
9.4.1 Caution when the GOT-F900 is connected to the computer link unit .....	9-15
9.4.2 Caution when displaying the Ascii code .....	9-15
9.5 Setting of Connected Equipment for GOT .....	9-16
9.6 Cable Diagram .....	9-23
9.6.1 Cautions on preparing cables .....	9-23
9.6.2 Cable diagram .....	9-23
9.7 Troubleshooting .....	9-27
10. Connection of MELSEC-QnA Series PLC .....	10-1
10.1 System Condition .....	10-2
10.1.1 Restriction When Computer Link Unit for A Series is Used .....	10-2
10.2 System Configuration .....	10-3
10.2.1 Applicable model .....	10-3
10.2.2 Configuration for Direct Connection (RS-422) .....	10-4
10.2.3 Configuration for QnA Computer Link Connection (RS-422) .....	10-6
10.2.4 Configuration for QnA Computer Link Connection (RS-232C) .....	10-8
10.3 Setting in QnA Computer Link Connection .....	10-10
10.3.1 Communication Setting Specifications .....	10-10
10.3.2 Setting Examples .....	10-11
10.4 Caution on Use of MELSEC-QnA Series PLC .....	10-13
10.4.1 Caution when the GOT is connected to the serial communication unit .....	10-13
10.4.2 Caution when the GOT is connected to the computer link for the A Series PLC ..	10-13
10.5 Setting of Connected Equipment for GOT .....	10-14
10.6 Cable Diagram .....	10-23
10.6.1 Cautions on preparing cables .....	10-23
10.6.2 Cable diagram .....	10-23
10.7 Troubleshooting .....	10-28

11.Connection of MELSEC-Q Series PLC .....	11-1
11.1 System Condition .....	11-2
11.2 System Configuration .....	11-3
11.2.1 Applicable model .....	11-3
11.2.2 Configuration for Direct Connection (RS-232C) .....	11-4
11.2.3 Configuration for Q Computer Link Connection (RS-422) .....	11-6
11.2.4 Configuration for Q Computer Link Connection (RS-232C) .....	11-8
11.3 Setting in Q Serial Communication Unit .....	11-10
11.3.1 Communication Setting Specifications .....	11-10
11.3.2 Setting by GPPW .....	11-11
11.3.3 Used Connectors and Connector Covers.....	11-12
11.4 Setting in Q Multi PLC System (Function version -B or later).....	11-13
11.4.1 Direct connection to QCPU .....	11-13
11.4.2 Connection to serial communication .....	11-14
11.5 Caution on Use of MELSEC-Q Series PLC.....	11-16
11.5.1 Restriction in device specification .....	11-16
11.5.2 Caution when the GOT is connected to the serial communication unit.....	11-16
11.5.3 Caution when connecting to Q multiple CPU system.....	11-17
11.5.4 Caution when setting screen creation software.....	11-17
11.6 Setting of Connected Equipment for GOT .....	11-18
11.7 Cable Diagram.....	11-25
11.7.1 Cautions on preparing cables.....	11-25
11.7.2 Cable diagram .....	11-25
11.8 Troubleshooting.....	11-29
12.Connection of FX Series Positioning Unit (FX(2N)-10/20GM).....	12-1
12.1 System Condition .....	12-1
12.2 System Configuration .....	12-2
12.2.1 Applicable model .....	12-2
12.2.2 Configuration for GMCPU direct connection (RS-422).....	12-2
12.3 Cautions on use of FX Series positioning unit.....	12-4
12.3.1 Device specification.....	12-4
12.3.2 Devices which can be monitored.....	12-4
12.3.3 Caution on connection of a programming tool to the FX Series positioning unit.....	12-4
12.4 Setting of Connected Equipment for GOT .....	12-5
12.5 Cable Diagram.....	12-11
12.5.1 Cautions on preparing cables.....	12-11
12.5.2 Cable diagram .....	12-11
12.6 Troubleshooting.....	12-14
13.Connection of FREQROL (S500/E500/A500) Inverter.....	13-1
13.1 System Condition .....	13-2
13.2 System Configuration .....	13-2
13.2.1 Applicable model .....	13-2
13.2.2 Configuration for CPU Direct Connection (RS-422) .....	13-3
13.3 Setting in FREQROL Inverter .....	13-7
13.3.1 Communication Setting Specifications .....	13-7
13.3.2 Setting Examples .....	13-8
13.3.3 Inverter Connector Specifications .....	13-10
13.3.4 Specification of Station Number in Creating Screen .....	13-11
13.4 Cautions on Use of FREQROL Series Inverter .....	13-12
13.4.1 Device specification.....	13-12
13.4.2 Changeover from the GOT (communication) to the PU operation mode .....	13-12
13.4.3 When "8888" or "9999" is set to a parameter (Pr) of the inverter .....	13-12
13.4.4 Specification of the program operation (PG) devices.....	13-13
13.4.5 Caution on setting of the calibration parameters (Pr900 to Pr905) .....	13-13
13.4.6 Restriction in simultaneous specification of PG and Pr devices on one screen....	13-13
13.4.7 Caution on connecting to the PU port (only in the E500 and the A500).....	13-13

13.5 Correspondence Between Devices of GOT and Parameters .....	13-14
13.6 FREQROL Inverter Parameter List.....	13-19
13.6.1 Parameters.....	13-19
13.6.2 Communication Parameters.....	13-26
13.7 Setting of Connected Equipment for GOT .....	13-27
13.8 Cable Diagram.....	13-33
13.8.1 Cautions on preparing cables.....	13-33
13.8.2 Cable diagram .....	13-33
13.9 Troubleshooting.....	13-37
14.Connection of Microcomputer .....	14-1
14.1 System Condition .....	14-2
14.2 System Configuration .....	14-3
14.2.1 Configuration for CPU Direct Connection (RS-422) .....	14-3
14.2.2 Configuration for CPU Direct Connection (RS-232C).....	14-5
14.3 Outline of Communication and Specifications .....	14-6
14.3.1 Outline of Communication .....	14-6
14.3.2 Communication Setting Specifications .....	14-7
14.4 Memory Map.....	14-7
14.4.1 Data Area .....	14-7
14.4.2 Special Memory Data List .....	14-10
14.4.3 Error Code List .....	14-12
14.5 Communication Command .....	14-13
14.5.1 Outline of Communication Procedure .....	14-13
14.5.2 Command List and Compatible Version of GOT-F900.....	14-14
14.5.3 Data Transfer Format (protocol).....	14-15
14.5.4 Character Code List .....	14-15
14.5.5 Station Number Setting .....	14-16
14.5.6 Sum Check Code .....	14-16
14.5.7 Interrupt Code List.....	14-17
14.6 Command Details .....	14-18
14.6.1 Batch Read Command.....	14-18
14.6.2 Batch Write Command .....	14-19
14.6.3 Bit-oriented Write Command .....	14-20
14.6.4 Fill Command .....	14-22
14.6.5 Interrupt Code .....	14-22
14.7 Caution on Use of Microcomputer Connection .....	14-23
14.7.1 When Using F920GOT-K .....	14-23
14.8 Setting of Connected Equipment for GOT .....	14-24
14.9 Cable Diagram.....	14-31
14.9.1 Cautions on preparing cables.....	14-31
14.9.2 Cable diagram .....	14-31
14.10 Troubleshooting .....	14-33
14.11 BASIC Program Example .....	14-35
15.Connection of SYSMAC C Series PLC (Manufactured by Omron) .....	15-1
15.1 System Condition .....	15-2
15.1.1 Classification of Host Link/Serial Communication Units.....	15-3
15.2 System Configuration .....	15-4
15.2.1 Applicable model .....	15-4
15.2.2 Configuration for SYSMAC C Host Link Connection (RS-422) .....	15-5
15.2.3 Configuration for SYSMAC C Host Link Connection (RS-232C).....	15-7
15.3 Communication Specifications for Host Link .....	15-9
15.4 Setting Examples in CQM1/CQM1H/C200H Series .....	15-10
15.5 Setting Examples in CS1/CJ1 Series .....	15-13
15.6 Setting Examples in SYSMAC $\alpha$ (C200HE/HG/HX)/CPM 1A/2A/2C Series ....	15-16

15.7 Caution on Use of SYSMAC C Series PLC .....	15-19
15.7.1 Modes in the SYSMAC C Series PLC .....	15-19
15.7.2 Forced ON/OFF on the device monitor screen of the GOT-F900 .....	15-19
15.7.3 Restriction in functions .....	15-19
15.7.4 When using F920GOT-K.....	15-19
15.8 Setting of Connected Equipment for GOT .....	15-20
15.9 Cable Diagram.....	15-26
15.9.1 Cautions on preparing cables.....	15-26
15.9.2 Cable diagram .....	15-27
15.10 Troubleshooting .....	15-31
16. Connection of FLEX-PC N Series PLC (Manufactured by Fuji Electric) .....	16-1
16.1 System Condition .....	16-1
16.2 System Configuration .....	16-2
16.2.1 Applicable model .....	16-2
16.2.2 Configuration for Link Unit Connection (RS-422) .....	16-3
16.2.3 Configuration for Link Unit Connection (RS-232C).....	16-4
16.3 Setting in Link Unit.....	16-5
16.3.1 Communication Setting Specifications .....	16-5
16.3.2 Setting Examples .....	16-6
16.4 Caution on Use of FLEX-PC N Series PLC .....	16-6
16.4.1 Devices which can be monitored.....	16-6
16.5 Setting of Connected Equipment for GOT .....	16-7
16.6 Cable Diagram.....	16-12
16.6.1 Cautions on preparing cables.....	16-12
16.6.2 Cable diagram .....	16-12
16.7 Troubleshooting.....	16-15
17. Connection of Machine Controller CP9200SH (PLC Manufactured by Yaskawa Electric) .....	17-1
17.1 System Condition .....	17-1
17.2 System Configuration .....	17-2
17.2.1 Applicable model .....	17-2
17.2.2 Configuration for CPU Direct Connection (RS-422) .....	17-3
17.2.3 Configuration for CPU Direct Connection (RS-232C).....	17-5
17.3 Setting in Machine Controller .....	17-7
17.3.1 Communication Setting Specifications .....	17-7
17.4 Setting of Connected Equipment for GOT .....	17-8
17.5 Cable Diagram.....	17-13
17.5.1 Cautions on preparing cables.....	17-13
17.5.2 Cable diagram .....	17-13
17.6 Troubleshooting.....	17-16
18. Connection of FP Series PLC (Manufactured by Matsushita Electric Works) .....	18-1
18.1 System Condition .....	18-2
18.1.1 Classification of Product Names .....	18-2
18.2 System Configuration .....	18-3
18.2.1 Applicable model .....	18-3
18.2.2 Configuration for CPU Direct Connection (RS-232C).....	18-4
18.3 Setting of Series .....	18-6
18.3.1 Communication Setting Specifications .....	18-6
18.3.2 Setting Examples in Computer Communication Unit.....	18-7
18.4 Cautions on Use of FP Series .....	18-8
18.4.1 Device specification.....	18-8
18.4.2 Devices which can be monitored.....	18-8
18.4.3 Cautions on connection of the control unit, the CPU unit and the computer communication unit .....	18-8

18.5 Setting of Connected Equipment for GOT .....	18-9
18.6 Cable Diagram.....	18-15
18.6.1 Cautions on preparing cables.....	18-15
18.6.2 Cable diagram .....	18-15
18.7 Troubleshooting.....	18-20
<b>19.Connection of SLC500/MicroLogix Series PLC</b>	
<b>(Manufactured by Allen-Bradley) .....</b>	<b>19-1</b>
19.1 System Condition .....	19-2
19.2 System Configuration .....	19-3
19.2.1 Applicable model .....	19-3
19.2.2 Configuration for CPU Direct Connection (RS-232C).....	19-3
19.3 Setting in SLC500.....	19-5
19.3.1 Communication Setting Specifications .....	19-5
19.3.2 GOT-F900 Transmission Specifications.....	19-5
19.4 Setting in MicroLogix .....	19-6
19.4.1 Communication Setting Specifications .....	19-6
19.4.2 GOT-F900 Transmission Specifications.....	19-6
19.5 Device Specification Method .....	19-7
19.5.1 Device Format .....	19-7
19.5.2 File Number and Element Range .....	19-9
19.5.3 Restriction in Device Specification .....	19-9
19.6 Caution on Use of SLC500/MicroLogix Series PLC .....	19-10
19.6.1 Device setting in advance .....	19-10
19.6.2 Caution on use of the sampling function .....	19-10
19.7 Setting of Connected Equipment for GOT .....	19-11
19.8 Cable Diagram.....	19-17
19.8.1 Cautions on preparing cables.....	19-17
19.8.2 Cable diagram .....	19-17
19.9 Troubleshooting.....	19-19
<b>20.Connection of SIMATIC S7-200/300/400 Series PLC</b>	
<b>(Manufactured by Siemens AG).....</b>	<b>20-1</b>
20.1 System Condition .....	20-2
20.2 System Configuration .....	20-3
20.2.1 Applicable model .....	20-3
20.2.2 Configuration for CPU Direct Connection (RS-232C).....	20-4
20.2.3 Introduction of Options Manufactured by Siemens AG .....	20-6
20.3 Setting in SIMATIC S7-200 .....	20-7
20.3.1 Communication Setting Specifications .....	20-7
20.3.2 GOT-F900 Transmission Specifications.....	20-9
20.4 Setting in SIMATIC S7-300/400 .....	20-9
20.4.1 Communication Setting Specifications .....	20-9
20.4.2 GOT-F900 Transmission Specifications.....	20-9
20.5 Device Specification Method .....	20-10
20.5.1 Device Format in SIMATIC S7-200 .....	20-10
20.5.2 Device Format in SIMATIC S7-300/400 .....	20-11
20.5.3 Supplementary Items .....	20-12
20.6 Caution on Use of SIMATIC S7-200/300/400 Series PLC .....	20-12
20.6.1 Restriction in devices depending on the model .....	20-12
20.6.2 Restriction in device specification .....	20-12
20.7 Setting of Connected Equipment for GOT .....	20-13
20.8 Cable Diagram.....	20-20
20.8.1 Cautions on preparing cables.....	20-20
20.8.2 Cable diagram .....	20-20
20.9 Troubleshooting.....	20-22



21.Connection of Printer.....	21-1
21.1 System Condition .....	21-1
21.2 System Configuration .....	21-2
21.2.1 Configuration for Printer Connection .....	21-2
21.2.2 Applicable port on GOT-F900 .....	21-2
21.3 Printer Communication Setting.....	21-2
21.3.1 Transmission Specifications and Communication Format.....	21-2
21.4 Cautions on Use of Printer .....	21-4
21.4.1 Caution on printer setting .....	21-4
21.4.2 Concurrent use of microcomputer and printer.....	21-4
21.5 Setting of Connected Equipment for GOT.....	21-5
21.6 Cable Diagram.....	21-7
21.6.1 Cautions on preparing cables.....	21-7
21.6.2 Cable diagram .....	21-7
22.Connection of Bar Code Reader .....	22-1
22.1 System Condition .....	22-2
22.2 Connection Configuration .....	22-2
22.2.1 Configuration for Bar Code Reader Connection .....	22-2
22.3 Bar Code Reader Communication Setting .....	22-3
22.3.1 Transmission Specifications and Communication Format.....	22-3
22.3.2 Bar Code Reader Control Devices .....	22-4
22.3.3 Bar Code Data Setting .....	22-6
22.3.4 Sequence Program Example .....	22-7
22.4 Caution on Use of Bar Code Reader .....	22-8
22.4.1 Caution on bar code reader setting .....	22-8
22.5 Setting of Connected Equipment for GOT .....	22-9
22.6 Cable Diagram.....	22-12
22.6.1 Cautions on preparing cables.....	22-12
22.6.2 Cable diagram .....	22-12
22.7 Troubleshooting.....	22-12
23.Appendix .....	23-1
23.1 Backlight ON/OFF Status Control Method and Replacement Procedure .....	23-2
23.1.1 Backlight Control Operation .....	23-2
23.1.2 Assigning Device to Control ON/OFF Status of the Backlight.....	23-3
23.1.3 Backlight Replacement Procedure .....	23-5
23.1.4 Cautions on Use of Backlight .....	23-6
23.2 Battery Voltage Drop Detection Method and Replacement Procedure .....	23-7
23.2.1 RAM Data When Battery Voltage Drops .....	23-7
23.2.2 Built-in battery model name and life .....	23-7
23.2.3 Assigning Device to Check Battery Voltage Drop .....	23-8
23.2.4 Battery Replacement Procedure .....	23-10
23.3 Connection of Programming Tools via FX-2PIF .....	23-12
23.3.1 How to Monitor Using A6GPP/A7PHP/HPP.....	23-12
23.3.2 Restrictions in Number of Devices Monitored When Using FX-2PIF .....	23-14
23.3.3 Switch Setting in FX-2PIF .....	23-16
23.3.4 Cautions on Use of FX-2PIF .....	23-17
23.3.5 Cautions on preparing cables.....	23-18
23.3.6 Cable Diagram .....	23-18
23.4 GOT-F900 Connector Signal Correspondence Table (Excluding the 5V type F920GOT-K.).....	23-19
23.4.1 RS-422 Correspondence Table.....	23-19
23.4.2 RS-232C Correspondence Table .....	23-19
23.5 Error Messages in GOT-F900 Series .....	23-20
23.5.1 Error Messages During Screen Operation .....	23-22



# 1. Introduction

We appreciate it very much that you have purchased Mitsubishi graphic operation terminal. Please read thoroughly this manual to understand sufficiently and use correctly the functions and the performance of the graphic operations terminal. Please make sure that this manual is delivered to the end user.

## 1.1 Rank and Use Method of This Manual

The following manuals are offered for the GOT-F900 Series. Each manual is classified in accordance with the purpose. Read a manual suitable to your purpose, then understand handling, operations and function of the GOT and the screen creation software GT Designer2, GT Designer and DU/WIN.

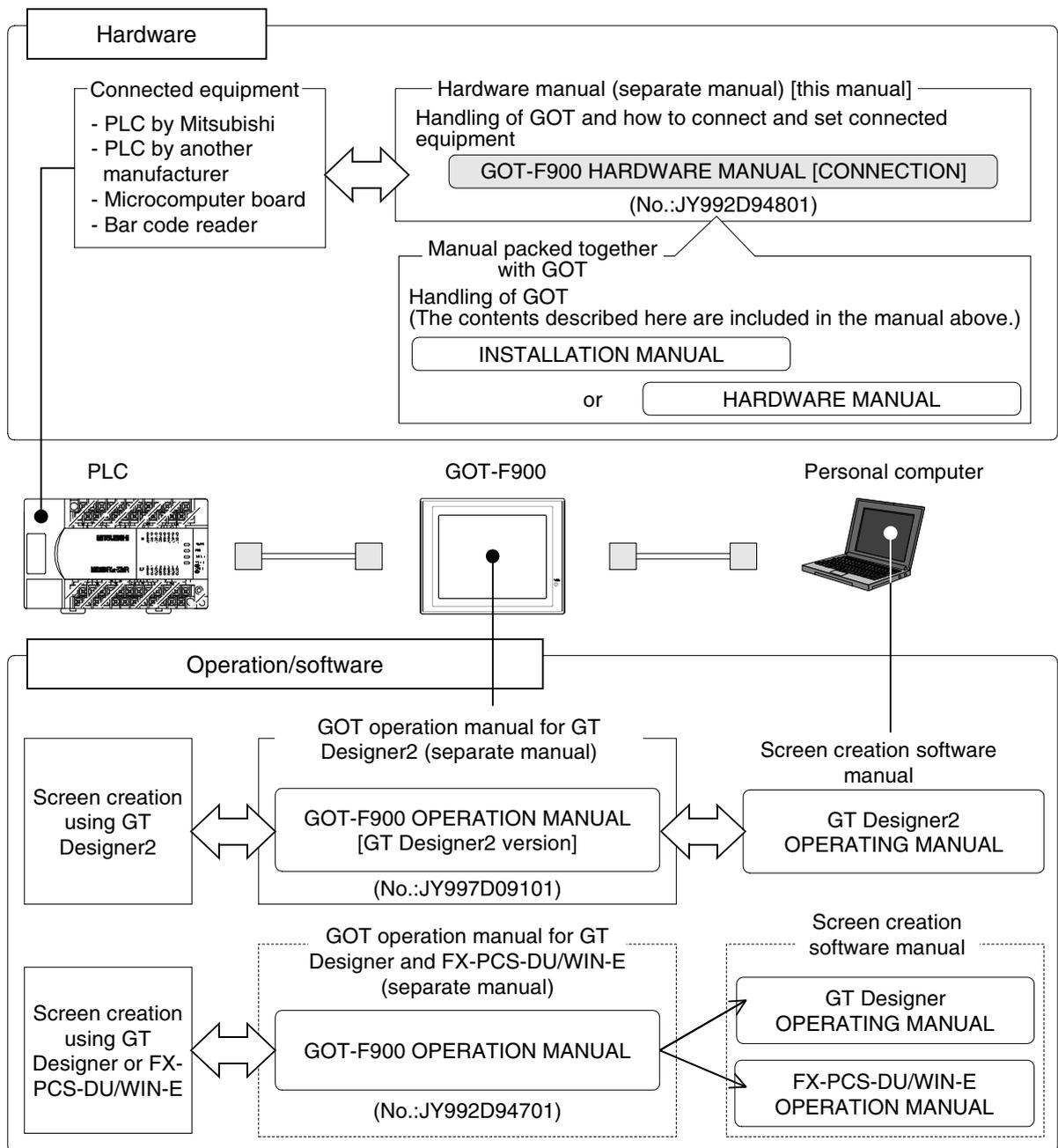

1	Introduction
2	Outline
3	Specifications
4	Installation and Wiring of F940GOT
5	Installation and Wiring of Handy GOT
6	Connection of Peripheral Equipment
7	Connection of Two or More GOT Units
8	Connection of MELSEC-F Series PLC
9	Connection of MELSEC-A Series PLC
10	Connection of MELSEC-QnA Series PLC

This manual describes how to set the screen creation software, select cables and perform wiring in connecting the GOT-F900 Series to a connected equipment.

Information Offered by Model name and In-built Fonts ..... Introduction  
Outline of Connection Types ..... Section 1  
Applicable PLC and connection type ..... Section 2  
Screen Creation Software Version  
Device Names Which can be Monitored



This manual can be classified as follows in accordance with the type of GOT-F900 Series.

F920GOT-K, F930GOT(-K), F940GOT or F940WGOT Series..... Read from Section 3.  
Handy GOT Series..... Read from Section 4.

### 1.1.1 Classification of Manuals in Accordance with Purpose

When requiring a manual not included with the product, contact our sales representative.

#### COMMON HARDWARE MANUAL (sent separately)

Corresponds to all of the F920GOT-K, F930GOT(-K), F940GOT and Handy GOT Series, and describes in details the connection to a PLC or personal computer and the setting method.

- GOT-F900 SERIES GRAPHIC OPERATION TERMINAL HARDWARE MANUAL [CONNECTION] (No. JY992D94801)
  - To learn how to connect the GOT to a personal computer (for screen data transfer).
  - To understand how to connect the main unit to equipment.
  - To learn how to set the screen creation software.

MODEL CODE	09R805
------------	--------

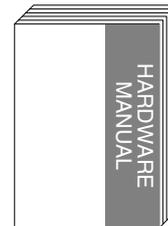

It is included as PDF data on CD-ROM of screen creation software SW□D5C-GTD2-E.  
It is included as PDF data on CD-ROM of screen creation software SW□D5C-GOTR-PACK.

#### HARDWARE MANUAL AND INSTALLATION MANUAL

Describes mainly the outside dimension, the installation, the power supply wiring and the electrical specifications.

- F920GOT-BBD5-K-E, F920GOT-BBD-K-E INSTALLATION MANUAL (No. JY997D02201)

- To learn the features of the main unit.
- To confirm the specifications of the main unit.
- To learn the name of each part of the main unit.
- To learn how to install the main unit and wire the power supply.
- To look at the external dimensions diagram of the main unit.



It is included with the F920GOT-BBD-K-E and F920GOT-BBD5-K-E.

- F930GOT INSTALLATION MANUAL (No. JY992D95701)

- To learn the features of the main unit.
- To confirm the specifications of the main unit.
- To learn the name of each part of the main unit.
- To learn how to install the main unit and wire the power supply.
- To look at the external dimensions diagram of the main unit.

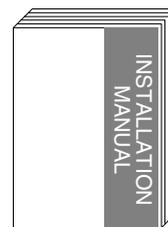

It is included with the F93□GOT-BWD-E.

- F930GOT-BBD-K-E INSTALLATION MANUAL (No. JY997D02501)

- To learn the features of the main unit.
- To confirm the specifications of the main unit.
- To learn the name of each part of the main unit.
- To learn how to install the main unit and wire the power supply.
- To look at the external dimensions diagram of the main unit.



It is included with the F930GOT-BBD-K-E.

- F940GOT INSTALLATION MANUAL (No. JY992D94201)
  - To learn the features of the main unit.
  - To confirm the specifications of the main unit.
  - To learn the name of each part of the main unit.
  - To learn how to install the main unit and wire the power supply.
  - To look at the external dimensions diagram of the main unit.

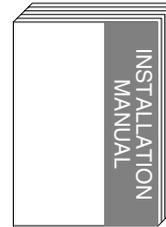

It is included with the F94□GOT-SWD-E and F94□GOT-LWD-E.

- F940WGOT INSTALLATION MANUAL (No. JY992D93901)
  - To learn the features of the main unit.
  - To confirm the specifications of the main unit.
  - To learn the name of each part of the main unit.
  - To learn how to install the main unit and wire the power supply.
  - To look at the external dimensions diagram of the main unit.

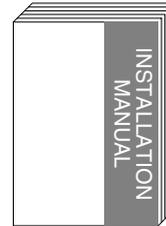

It is included with the F940WGOT-TWD-E.

- F940 HANDY GOT HARDWARE MANUAL (No. JY992D86901)
  - To learn the features of the main unit.
  - To confirm the specifications of the main unit.
  - To learn the name of each part of the main unit.
  - To learn how to install the main unit.
  - To look at the external dimensions diagram of the main unit.

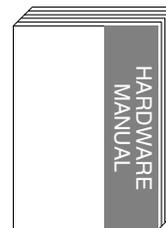

It is included with the F94□GOT-SBD-H-E and F94□GOT-LBD-H-E.

MODEL CODE	09R810
------------	--------

- F940 HANDY GOT (RH model) HARDWARE MANUAL (No. JY992D99901)
  - To learn the features of the main unit.
  - To confirm the specifications of the main unit.
  - To learn the name of each part of the main unit.
  - To learn how to install the main unit.
  - To look at the external dimensions diagram of the main unit.

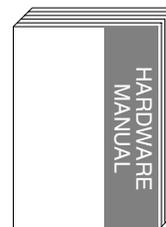

It is included with the F94□GOT-SBD-RH-E and F94□GOT-LBD-RH-E.

MODEL CODE	09R811
------------	--------

**OPERATION MANUAL of GOT (sent separately)**

Describes how to operate system screens and how to create and operate user screens, and covers all of the F920GOT-K, F930GOT(-K), F940GOT and Handy GOT.

- GOT-F900 SERIES OPERATION MANUAL (No. JY992D94701)
  - To learn the display function of the GOT-F900.
  - To execute items in the HPP mode (such as "PROGRAM LIST" and "MONITOR").
  - To execute "DEVICE MONITOR" and display alarms.



Applicable GOT  
 F920GOT-BBD-K-E  
 F920GOT-BBD5-K-E  
 F930GOT-BWD-E  
 F930GOT-BBD-K-E  
 F94□GOT-SWD-E  
 F94□GOT-LWD-E  
 F940WGOT-TWD-E  
 F94□GOT-SWD-(R)H-E  
 F94□GOT-LBD-(R)H-E

Screen creation software

GT Designer and FX-PCS-DU/WIN-E are supported.

MODEL CODE	09R804
------------	--------

- GOT-F900 SERIES OPERATION MANUAL [GT Designer2] (No. JY997D09101)
  - To learn the display function of the GOT-F900.
  - To execute items in the HPP mode (such as "PROGRAM LIST" and "MONITOR").
  - To execute "DEVICE MONITOR" and display alarms.



Applicable GOT  
 F920GOT-BBD-K-E  
 F920GOT-BBD5-K-E  
 F930GOT-BWD-E  
 F930GOT-BBD-K-E  
 F94□GOT-SWD-E  
 F94□GOT-LWD-E  
 F940WGOT-TWD-E  
 F94□GOT-SWD-(R)H-E  
 F94□GOT-LBD-(R)H-E  
 It is distributed as PDF data saved in the CD-ROM of the SW□D5C-GTD2-E.

Screen creation software  
 GT Designer2 is supported.

<b>MODEL CODE</b>	09R813
-------------------	--------

**OPERATION MANUAL of screen creation software**

Two types of screen creation software are offered. The manual of the software you are using is required (It is included with the software.).

GT Designer2

- GT Designer2 (SW□D5C-GTD2-E) OPERATING MANUAL (separate manual)  
 Consult with the distributor from which you have purchased GT Designer2.
  - To install the software to the personal computer.
  - To start up each software.
  - To learn how to connect the personal computer to the GOT.
  - To learn the screen configuration of the software.
  - To learn the outline of diversified monitoring functions.
  - To learn the procedure to display the monitor screen.
  - To learn how to use the library function.
  - To learn how to draw graphics.



It is distributed as PDF data saved in the CD-ROM of the SW□D5C-GTD2-E.

- GT Designer2 (SW□D5C-GTD2-E) REFERENCE MANUAL (separate manual)  
 Consult with the distributor from which you have purchased GT Designer2.
  - To learn the types and specifications of GOT screens.
  - To learn the device range which can be monitored.
  - To learn common items to be set at the beginning.
  - To learn how to set and display the key window.
  - To learn how to use each object function.
  - To learn how to use the script function.



It is distributed as PDF data saved in the CD-ROM of the SW□D5C-GTD2-E.

GT Designer

- GT Designer (SW□D5C-GOTR-PACKE) OPERATING MANUAL
  - To install the software to the personal computer.
  - To start up the software.
  - To learn how to connect the personal computer to the GOT.
  - To learn the screen configuration of the software.
  - To learn the outline of diversified monitoring functions.
  - To learn the procedure to display the monitor screen.
  - To learn how to use the help function.

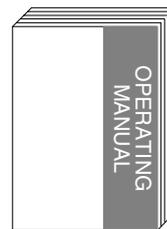

It is distributed as PDF data saved in the CD-ROM of the SW□D5C-GOTR-PACKE.

<b>1</b>	Introduction
<b>2</b>	Outline
<b>3</b>	Specifications
<b>4</b>	Installation and Wiring of F940GOT
<b>5</b>	Installation and Wiring of Handy GOT
<b>6</b>	Connection of Peripheral Equipment
<b>7</b>	Connection of Two or More GOT Units
<b>8</b>	Connection of MELSEC-F FX Series PLC
<b>9</b>	Connection of MELSEC-A Series PLC
<b>10</b>	Connection of MELSEC-QnA Series PLC

- FX-PCS-DU/WIN-E OPERATION MANUAL (No: JY992D68301)
  - To install the software to the personal computer.
  - To start up the software.
  - To learn how to connect the personal computer to the GOT.
  - To learn the screen configuration of the software.
  - To learn how to use the help function.

MODEL CODE	09R910
------------	--------



It is included with the FX-PCS-DU/WIN-E.



## 1.2 Abbreviations, Generic Names and Terms Used in This Manual

Abbreviations, generic names and terms used in this manual are shown below.

### 1.2.1 Types and Names of GOT-F900 Series

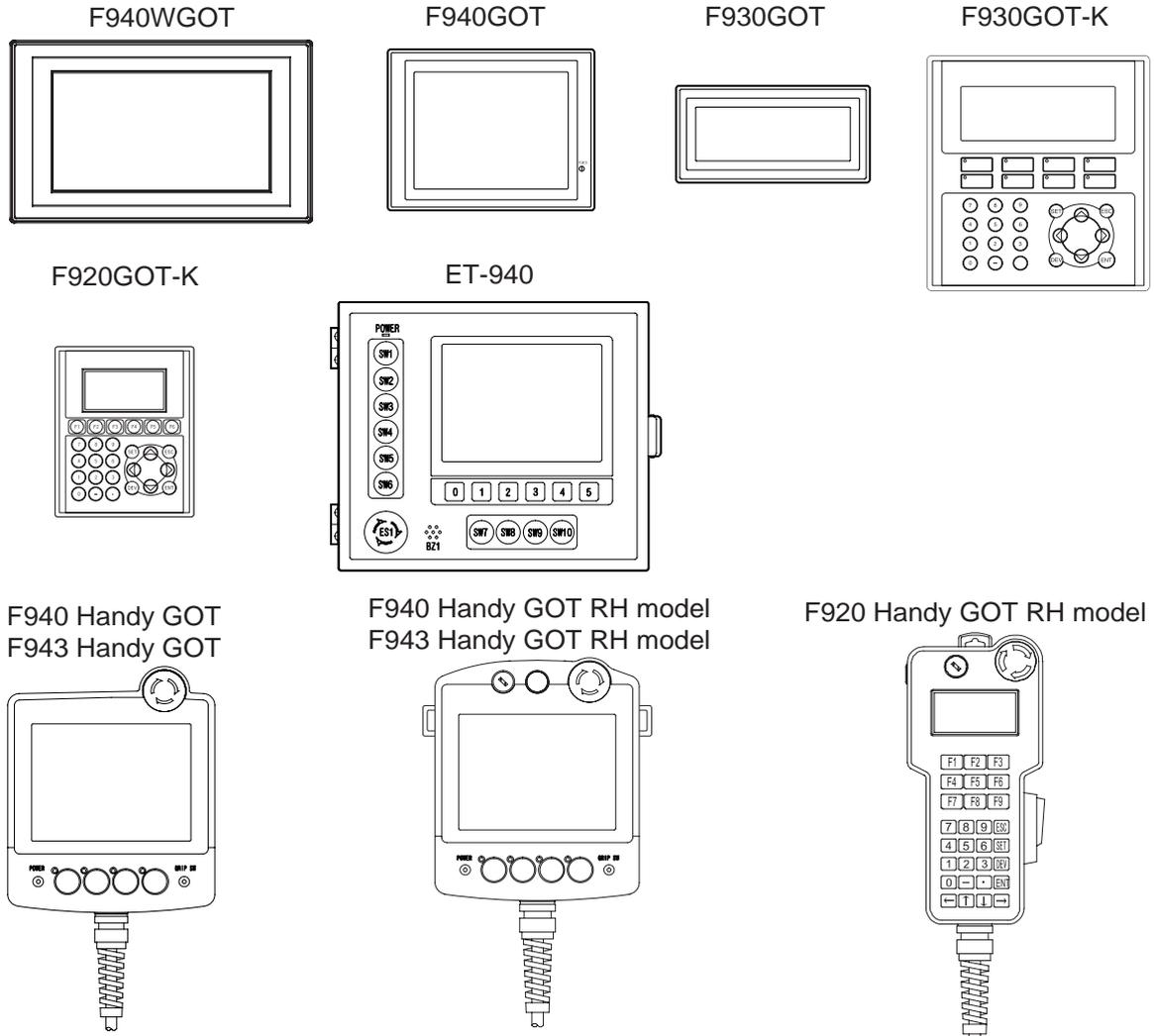

Generic name	Name	Model name	Built-in I/F	Remarks
GOT-F900 Series	F940WGOT	F940WGOT-TWD	RS-422 ×1	Japanese models
		F940WGOT-TWD-E, F940WGOT-TWD-C	RS-232C ×2	World spec models
	F940GOT	F940GOT-SWD, F940GOT-LWD	RS-422 ×1 RS-232C ×1	Japanese models
		F940GOT-SWD-E, F940GOT-LWD-E F940GOT-SWD-C, F940GOT-LWD-C	RS-422 ×1 RS-232C ×1	World spec models
	F943GOT	F943GOT-SWD, F943GOT-LWD	RS-232C ×2	Japanese models
	F930GOT-K	F930GOT-BBD-K	RS-422 ×1	Japanese models
		F930GOT-BBD-K-E, F930GOT-BBD-K-C	RS-232C ×1	World spec models
	F930GOT	F930GOT-BWD		Japanese models
		F930GOT-BWD-E F930GOT-BWD-C F930GOT-BWD-T	RS-422 ×1 RS-232C ×1	World spec models
		F933GOT	F933GOT-BWD	RS-232C ×2

1	Introduction
2	Outline
3	Specifications
4	Installation and Wiring of F940GOT
5	Installation and Wiring of Handy GOT
6	Connection of Peripheral Equipment
7	Connection of Two or More GOT Units
8	Connection of MELSEC-F Series PLC
9	Connection of MELSEC-A Series PLC
10	Connection of MELSEC-QnA Series PLC

Generic name	Name		Model name	Built-in I/F	Remarks
GOT-F900 Series	F920GOT-K	5V	F920GOT-BBD5-K	RS-422 ×1	Japanese models
			F920GOT-BBD5-K-E, F920GOT-BBD5-K-C	RS-232C ×1	World spec models
		24V	F920GOT-BBD-K	RS-422 ×1	Japanese models
			F920GOT-BBD-K-E, F920GOT-BBD-K-C	RS-232C ×1	World spec models
	F920 Handy GOT RH model		F920GOT-BBD-RH	RS-422 ×1	Japanese models
	F940 Handy GOT *1		F940GOT-SBD-H, F940GOT-LBD-H F940GOT-SBD-RH, F940GOT-LBD-RH	RS-422 ×1	Japanese models
			F940GOT-SBD-H-E, F940GOT-LBD-H-E F940GOT-SBD-RH-E, F940GOT-LBD-RH-E		World spec models
	F943 Handy GOT *1		F943GOT-SBD-H, F943GOT-LBD-H F943GOT-SBD-RH, F943GOT-LBD-RH	RS-232C ×1	Japanese models
			F943GOT-SBD-H-E, F943GOT-LBD-H-E F943GOT-SBD-RH-E, F943GOT-LBD-RH-E		World spec models
	ET-900		ET-940BH, ET-940BH-L ET-940PH, ET-940PH-L	RS-422 ×1 RS-232C ×1	Japanese models

\*1 In addition to the interface shown in the table, an RS-232C interface is built in for connection of a personal computer.

\*2 May be abbreviated as F920 Handy GOT in the sentences.

- Both the F940 Handy GOT and the F943 Handy GOT are generally called "Handy GOT".
- In the remarks, Japanese models are for Japan, and world spec models the other countries than Japan.

1.2.2 Information Offered by Model Name

GOT								
F9	□	□	□	GOT	-	○	○	○
1)	2)	3)		4)	5)	6)	7)	8)
1) LC display size 2: 3 in. 3: 4 in. 4: 6 in. (7 in. in F940WGOT)								
2) PLC connection specifications 0: RS-422,RS-232C Interface 3: RS-232C × 2ch interface In the case of Handy GOT 0: RS-422 Interface 3: RS-232C interface								
3) Screen shape None: Standard W: Wide screen								
4) Screen color T: TFT type 256-color LCD S: STN type 8-color LCD L: STN type black-and-white LCD B: STN type blue LCD								
5) Panel color W: White B: Black								
6) Input power supply specifications D: 24V DC D5: 5V DC								
7) Various keys None: Not with a key K: With a key								
8) Type None: Panel face installation type H: Handy GOT RH: Handy GOT (With a keylock switch)								
9) Overseas models E: ] In-built fonts vary depending on model. C: ] T: ] For details, refer to the next page.								

1	Introduction
2	Outline
3	Specifications
4	Installation and Wiring of F940GOT
5	Installation and Wiring of Handy GOT
6	Connection of Peripheral Equipment
7	Connection of Two or More GOT Units
8	Connection of MELSEC-F FX Series PLC
9	Connection of MELSEC-A Series PLC
10	Connection of MELSEC-QnA Series PLC

### 1.2.3 In-built Fonts of Graphic Operation Terminal (Japanese/Overseas product)

Carefully confirm the in-built fonts when selecting a model from the F920GOT-K or F930GOT(-K).

Name	GOT model name *1	Language displayed on system screen *2		In-built fonts (user screen) *3																
		At factory	Can be switched to	Japanese		English	Korean	Chinese		Western Europe										
				JIS Chinese character code first standard	JIS Chinese character code second standard	English	Korean	Simplified	Traditional	Italian	Dutch	Swedish	Spanish	German	Portuguese	French				
F940WGOT	F940WGOT-TWD	Japanese	English	✓	✓	✓	✓	✓	✓	✓	✓	✓	✓	✓	✓	✓	✓	✓		
	F940WGOT-TWD-E	English	Japanese	✓	✓	✓	✓	✓	✓	✓	✓	✓	✓	✓	✓	✓	✓	✓		
	F940WGOT-TWD-C	Chinese (Simplified)	English	✓	✓	✓	✓	✓	✓	✓	✓	✓	✓	✓	✓	✓	✓	✓		
F940GOT	F94□GOT-SWD	Japanese	English	✓	–	✓	✓	✓	✓	✓	✓	✓	✓	✓	✓	✓	✓	✓		
	F94□GOT-LWD			–	–	–	–	–	–	–	–	–	–	–	–	–	–	–	–	
	F940GOT-SWD-E	English	Japanese	✓	–	✓	✓	✓	✓	✓	✓	✓	✓	✓	✓	✓	✓	✓		
	F940GOT-LWD-E			–	–	–	–	–	–	–	–	–	–	–	–	–	–	–	–	
	F940GOT-SWD-C			Chinese (Simplified)	English	✓	–	✓	✓	✓	✓	✓	✓	✓	✓	✓	✓	✓	✓	✓
	F940GOT-LWD-C					–	–	–	–	–	–	–	–	–	–	–	–	–	–	–
F930GOT-K	F930GOT-BBD-K	Japanese	English	✓	✓*5	✓	–	–	–	✓	✓	✓	✓	✓	✓	✓	✓	✓		
	F930GOT-BBD-K-E	English	Japanese	✓	–	✓	✓*4	–	–	✓	✓	✓	✓	✓	✓	✓	✓	✓		
	F930GOT-BBD-K-C	Chinese (Simplified)	English	–	–	✓	–	✓	–	–	–	–	–	–	–	–	–	–		
F930GOT	F93□GOT-BWD	Japanese	English	✓	✓*5	✓	–	–	–	✓	✓	✓	✓	✓	✓	✓	✓	✓		
	F930GOT-BWD-E	English	Japanese	✓	–	✓	✓*4	–	–	✓	✓	✓	✓	✓	✓	✓	✓	✓		
	F930GOT-BWD-C	Chinese (Simplified)	English	–	–	✓	–	✓	–	–	–	–	–	–	–	–	–	–		
	F930GOT-BWD-T	English	–	–	–	✓	–	–	✓	–	–	–	–	–	–	–	–	–		
F920GOT-K	F920GOT-BBD(5)-K	Japanese	English	✓	✓	✓	–	–	–	✓	✓	✓	✓	✓	✓	✓	✓	✓		
	F920GOT-BBD(5)-K-E	English	Japanese	✓	✓	✓	✓*4	–	–	✓	✓	✓	✓	✓	✓	✓	✓	✓		
	F920GOT-BBD(5)-K-C	Chinese (Simplified)	English	–	–	✓	–	✓	✓	–	–	–	–	–	–	–	–	–		
Handy GOT	F94□GOT-SBD-H	Japanese	English	✓	–	✓	✓	✓	✓	✓	✓	✓	✓	✓	✓	✓	✓	✓		
	F94□GOT-LBD-H			–	–	–	–	–	–	–	–	–	–	–	–	–	–	–	–	
	F94□GOT-SBD-H-E	English	Japanese	✓	–	✓	✓	✓	✓	✓	✓	✓	✓	✓	✓	✓	✓	✓		
	F94□GOT-LBD-H-E			–	–	–	–	–	–	–	–	–	–	–	–	–	–	–	–	
Handy GOT (RH model)	F920GOT-BBD-RH	Japanese	English	✓	✓	✓	–	–	–	✓	✓	✓	✓	✓	✓	✓	✓	✓		
	F94□GOT-SBD-RH	Japanese	English	✓	–	✓	✓	✓	✓	✓	✓	✓	✓	✓	✓	✓	✓	✓		
	F94□GOT-LBD-RH			–	–	–	–	–	–	–	–	–	–	–	–	–	–	–	–	
	F94□GOT-SBD-RH-E	English	Japanese	✓	–	✓	✓	✓	✓	✓	✓	✓	✓	✓	✓	✓	✓	✓		
F94□GOT-LBD-RH-E	–			–	–	–	–	–	–	–	–	–	–	–	–	–	–	–		
ET-900	ET-940PH	Japanese	English	✓	–	✓	✓	✓	✓	✓	✓	✓	✓	✓	✓	✓	✓	✓		
	ET-940PH-L			–	–	–	–	–	–	–	–	–	–	–	–	–	–	–	–	
	ET-940BH			–	–	–	–	–	–	–	–	–	–	–	–	–	–	–	–	
	ET-940BH-L			–	–	–	–	–	–	–	–	–	–	–	–	–	–	–	–	

\*1 □ in the GOT model name indicates 0 or 3. (The in-built interface varies as shown below.)

Name	0	3
F940GOT, F930GOT	RS-422(1), RS-232C(1)	RS-232C(2)
Handy GOT, Handy GOT RH model	RS-422(1)	RS-232C(1)

\*2 A change on a system screen can be made in the screen creation software or GOT main unit.

\*3 The font which can be displayed on a user screen  
Depending on the OS, the font may not be displayed even if it is built in the GOT-F900.

\*4 Only the Hangul is available.

\*5 Supported from units manufactured in January, 2003 (serial No. 31\*\*\*\*).

1.2.4 Abbreviation List

Abbreviation/generic name/term		Description
CPU	QCPU(Q mode)	Generic name of Q00JCPU, Q00CPU, Q01CPU, Q02CPU, Q02HCPU, Q06HCPU, Q12HCPU and Q25HCPU units
	QCPU(A mode)	Generic name of Q02CPU-A, Q02HCPU-A and Q06HCPU-A units
	QCPU	Generic name of QCPU (Q mode) and QCPU (A mode) units
	QnACPU(large type)	Generic name of Q2ACPU, Q2ACPU-S1, Q3ACPU, Q4ACPU and Q4ARCPU units
	QnACPU(small type)	Generic name of Q2ASCPU, Q2ASCPU-S1, Q2ASHCPU and Q2ASHCPU-S1 units
	QnACPU	Generic name of QnACPU (large type) and QnACPU (small type) units
	AnUCPU	Generic name of A2UCPU, A2UCPU-S1, A3UCPU and A4UCPU units
	AnACPU	Generic name of A2ACPU, A2ACPU-S1 and A3ACPU units
	AnNCPU	Generic name of A1NCPU, A2NCPU, A2NCPU-S1 and A3NCPU units
	ACPU(large type)	Generic name of AnUCPU, AnACPU and AnNCPU units
	A2US(H)CPU	Generic name of A2USCPU, A2USCPU-S1 and A2USHCPU-S1 units
	AnS(H)CPU	Generic name of A1SCPU, A1SHCPU and A2SCPU units
	A1SJ(H)CPU	Generic name of A1SJCPU-S3 and A1SJHCPU units
	ACPU(small type)	Generic name of A2US(H)CPU, AnS(H)CPU and A1SJ(H)CPU units
	ACPU	Generic name of ACPU (large type), ACPU (small type) and A1FXCPU units
	FX0 Series	Generic name of FX0 Series main units
	FX0s Series	Generic name of FX0s Series main units
	FX1s Series	Generic name of FX1s Series main units
	FX0N Series	Generic name of FX0N Series main units
	FX1N Series	Generic name of FX1N Series main units
	FX1 Series	Generic name of FX1 Series main units
	FX Series	Generic name of FX Series main units
	FX2 Series	Generic name of FX2 Series main units
	FX2N Series	Generic name of FX2N Series main units
	FX3U Series	Generic name of FX3U Series main units
	FX2C Series	Generic name of FX2C Series main units
	FX2NC Series	Generic name of FX2NC Series main units
	FX3UC Series	Generic name of FX3UC Series main units
	FXCPU	Generic name of FX0/FX0s/FX1s/FX0N/FX1N/FX1/FX/FX2/FX2N/FX3U/FX2C/FX2NC/FX3UC Series main units
	FX Series GM positioning unit	FX-10GM, FX-20GM, E-20GM, FX2N-10GM and FX2N-20GM
A Motion controller CPU	Generic name of A171SCPU-S3, A171SHCPU, A172SHCPU and A273UHCPU	
FREQROL Series	A500/E500/S500 Series inverter	
PLC by other companies	PLC by Omron	Generic name of C200H, C200HE, C200HG, C200HX, CQM1, CS1, CPM1A, CPM2A, CPM2C and CJ1
	PLC by Fuji Electric	Generic name of FLEX-PC N Series (NB-RS1-AC, NB-RS1-DC, NJ-RS4, NJ-RS1 and NJ-RS2)
	PLC by Yasukawa Electric	Generic name of machine controllers CP-9200SH, MP-920 and MP-930
	PLC by Matsushita Electric Works	Generic name of FP0, FP2SH, FP2SH+FP2-CCU and FPΣ

1	Introduction
2	Outline
3	Specifications
4	Installation and Wiring of F940GOT
5	Installation and Wiring of Handy GOT
6	Connection of Peripheral Equipment
7	Connection of Two or More GOT Units
8	Connection of MELSEC-F Series PLC
9	Connection of MELSEC-A Series PLC
10	Connection of MELSEC-QnA Series PLC

Abbreviation/generic name/term		Description		
PLC by other companies	PLC by Allen Bradley	Generic name of SLC 5/03 and SLC 5/04		
	PLC by Siemens	Generic name of SIMATIC S7-200, S7-300 and S7-400		
	PLC by another company	Generic name of PLC manufactured by Omron, Fuji Electric, Yasukawa Electric, Allen-Bradley or Siemens		
Others	OS	Abbreviation of GOT system software		
	GT Designer2	Abbreviation of screen creation software for GOT-A900/GOT-F900 Series		
		GT Works2	SW□D5C-GTWK2-J	Integrated screen development software for GOT900 Series (SW□D5C-GTD2-J + GT Simulator2 + GT SoftGOT2) (Japanese version)
			SW□D5C-GTWK2-JV	The product for upgrade of the integrated screen development software for GOT 900 series (SW□D5C-GTD2-J + GT Simulator2 + GT SoftGOT2) (Japanese version)
			SW□D5C-GTWK2-E	Integrated screen development software for GOT900 Series (SW□D5C-GTD2-E + GT Simulator2 + GT SoftGOT2) (English version)
			SW□D5C-GTWK2-EV	The product for upgrade of the integrated screen development software for GOT 900 series (SW□D5C-GTD2-E + GT Simulator2 + GT SoftGOT2) (English version)
		GT Designer2	SW□D5C-GTD2-J	Screen creation software for GOT900 Series (SW□D5C-GTD2-J + GT SoftGOT2) (Japanese version)
			SW□D5C-GTD2-JV	The product for upgrade of the screen creation software for GOT 900 series (SW□D5C-GTD2-J + GT SoftGOT2) (Japanese version)
			SW□D5C-GTD2-E	Screen creation software for GOT900 Series (SW□D5C-GTD2-E + GT SoftGOT2) (English version)
	SW□D5C-GTD2-EV		The product for upgrade of the screen creation software for GOT 900 series (SW□D5C-GTD2-E + GT SoftGOT2) (English version)	

Abbreviation/generic name/term		Description		
Others	GT Designer	Abbreviation of screen creation software for GOT-A900/GOT-F900 Series		
		GT Works	SW□D5C-GTWORKS	Integrated screen development software for GOT900 Series (SW□D5C-GOTR-PACK + GT Simulator) (Japanese version)
			SW□D5C-GTWORKS-V	Software dedicated to version upgrade from conventional version to latest SW□D5C-GTWORKS (Japanese version)
			SW□D5C-GTWORKS-E	Integrated screen development software for GOT900 Series (SW□D5C-GOTR-PACKE + GT Simulator) (English version)
		GT Designer	SW□D5C-GOTR-PACK	Screen creation software for GOT900 Series (Japanese version)
			SW□D5C-GOTR-PACKV	Software dedicated to version upgrade from conventional version to latest SW□D5C-GOTR-PACK (Japanese version)
	SW□D5C-GOTR-PACKE		Screen creation software for GOT900 Series (English version)	
	DU/WIN	Abbreviation of screen creation software FX-PCS-DU/WIN-E for GOT-F900 Series		
	FX/WIN	Abbreviation of programming software FX-PCS/WIN-E for FX Series PLC		
	Data conversion software	Abbreviation of data conversion software GOT Converter for GOT900 Series		
	Debugging software	Abbreviation of debugging software GOT Debugger		
	Object	Parts and setting data on the screen.		
	Windows95	Abbreviation of Microsoft Windows95		
	Windows98	Abbreviation of Microsoft Windows98		
Windows NT4.0	Abbreviation of Microsoft Windows NT Workstation 4.0			
Windows2000	Abbreviation of Microsoft Windows2000 Professional			
WindowsXP	Abbreviation of Microsoft WindowsXP Professional Abbreviation of Microsoft WindowsXP Home Edition			
Windows	Generic name of Windows95, Windows98, Windows NT4.0, Windows2000 and WindowsXP			
Personal computer (PC)	Personal computer compatible with Windows to which GT Designer2, GT Designer or DU/WIN is installed			

This manual describes the following product in the new name.

Conventional name	New name	Remarks
GPPW	GX Developer	Abbreviation of software package SW□D5C-GPPW-E

Abbreviation/generic name/term		Description
Connection diagram	BK	Black
	W	White
	Y	Yellow
	BR	Brown
	BL	Blue
	GY	Gray
	O	Orange
	PL	Purple
	PK	Pink
	LTGR	Light green
	SB	Sky blue
	R	Red
	GR	Green



## 2. Outline

This section describes the outline of PLC, bar code reader, printer, etc. which can be connected to the GOT-F900.

### 2.1 Connection Type Supported by GOT-F900

The table below shows connection types supported by the GOT-F900 having the latest OS version.

#### 2.1.1 GOT type list and index

Connected equipment	Connection destination	Description	Reference
F920GOT-K, F930GOT, F930GOT-K, F940GOT, F940WGOT	–	Name of each part, installation and power supply wiring	Chapter 4
Handy GOT	–	Dedicated wiring and functions of Handy GOT such as name of each part, installation, cables dedicated to Handy GOT and switch control method	Chapter 5
Connection of peripheral equipment	Peripheral equipment	Cable used to connect the personal computer to transfer screen data and sequence programs	Chapter 6
Connection of two or more GOT units	GOT-GOT	Wiring among up to four connected GOT units	Chapter 7

1

Introduction

2

Outline

3

Specifications

4

Installation and Wiring of F940GOT

5

Installation and Wiring of Handy GOT

6

Connection of Peripheral Equipment

7

Connection of Two or More GOT Units

8

Connection of MELSEC-F FX Series PLC

9

Connection of MELSEC-A Series PLC

10

Connection of MELSEC-QnA Series PLC

## 2.1.2 Connection type list and index

"✓" indicates can connect. "-" indicates cannot connect.

Manufacturer	Connected equipment	Connection destination	Transmission specifications		Connection of two or more GOT units	Reference
			RS-422	RS-232C		
PLC by Mitsubishi	FX Series	CPU direct connection	✓	✓	✓	Chapter 8
	A Series	CPU direct connection	✓	-	✓	Chapter 9
		A computer link	✓	✓	-	
	A Motion controller	CPU direct connection	✓	-	✓	Chapter 9
		A computer link	✓	✓	-	
	QnA Series	CPU direct connection	✓	-	✓	Chapter 10
		A computer link	✓	✓	-	
		QnA computer link	✓	✓	✓	
	Q Series (A mode)	CPU direct connection	-	-	-	-
		A computer link	-	-	-	
	Q Series (Q mode)	CPU direct connection	-	✓	✓	Chapter 11
Serial communication unit (CPU direct connection)		✓	✓	✓		
Q Series (multi CPU)	CPU direct connection	-	✓	✓	Chapter 11	
	Serial communication unit (CPU direct connection)	✓	✓	✓		
FX positioning unit (10GM/20GM)	CPU direct connection	✓	-	-	Chapter 12	
FREQROL Series (inverter)	CPU direct connection	✓	-	-	Chapter 13	
PLC by other companies	General-purpose equipment such as microcomputer board	CPU direct connection	✓	✓	✓	Chapter 14
	SYSMAC C Series by Omron	Upper link	✓	✓	-	Chapter 15
	FLEX-PC N Series by Fuji Electric	Link unit	✓	✓	-	Chapter 16
	Machine controller by Yasukawa Electric	CPU direct connection (memo bus)	-	✓	-	Chapter 17
		Memo bus unit	✓	✓	-	
	FP Series by Matsushita Electric Works	CPU direct connection	-	✓	-	Chapter 18
	SLC500/MicroLogix Series by Allen-Bradley	CPU direct connection	-	✓	-	Chapter 19
SIMATIC S7-200 SIMATIC S7-300 SIMATIC S7-400 Series by Siemens	CPU direct connection	-	✓	-	Chapter 20	
Others	General-purpose printer	-	-	✓	-	Chapter 21
	Bar code reader	-	-	✓	-	Chapter 22

- For the details of the connection type in accordance with the OS version of the GOT-F900, refer to section 3.1.

## 2.2 Outline of Connection Types

This section explains by means of diagrams the connection types of PLC, bar code reader, printer and personal computer (for sequence programs) connected to the GOT-F900.

The same type of equipment cannot be connected. (For example, connection of two PLC units or connection of two bar code readers are not allowed.)

The compatible connection types vary according to the model of the GOT-F900. For details, refer to the specifications shown later.

### 2.2.1 PLC by Mitsubishi

This section describes the outline of connection of the GOT-F900 to the PLC manufactured by Mitsubishi.

"  " indicates that a PLC programming tool (personal computer) can be connected.

(Program transfer and monitoring are available using the programming software for the FX/A/QnA/Q Series.)

#### FX Series PLC

##### 1) CPU direct connection (RS-422)

GOT-F900 is connected to the programming port of the FX Series PLC. When a personal computer is connected to the GOT-F900, sequence programs can be created.

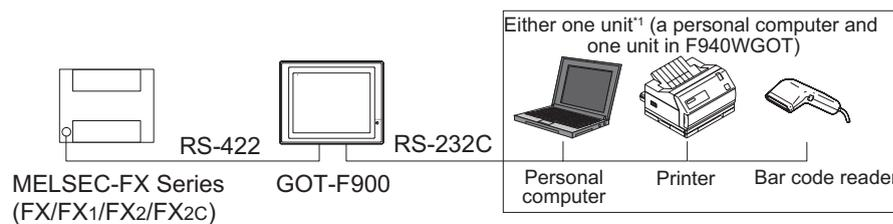

By attaching the optional RS-422 communication board, a programming port can be added. As a result, a GOT-F900 or personal computer (for sequence programs) can be connected to each port.

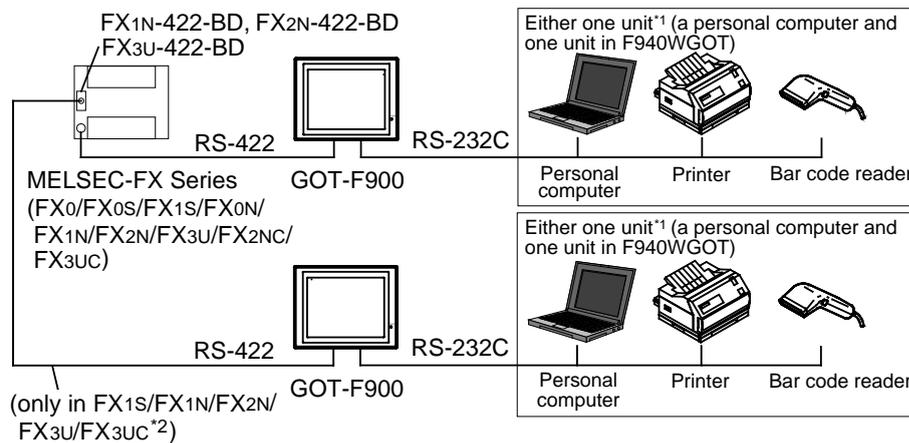

\*1 Excluding the F920GOT-K

\*2 Excluding the FX3UC(D, DSS)

**2) CPU direct connection (RS-232C)**

By attaching the optional RS-232C communication board, a programming port can be added. As a result, the GOT-F900 or personal computer (for sequence programs) can be connected to each port. (A personal computer, printer or bar code reader can be connected only when the GOT is equipped with two RS-232C channels.)

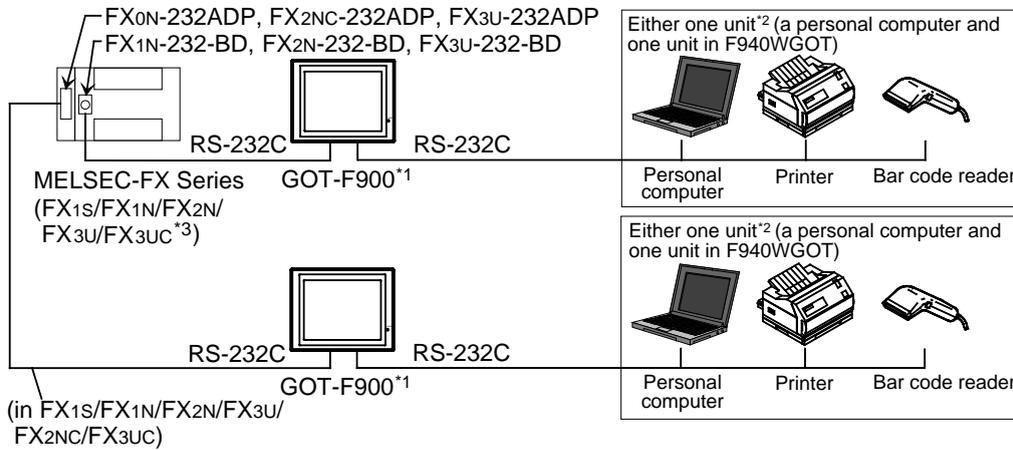

\*1 Excluding the 5V type F920GOT-K.

\*2 Excluding the F920GOT-K

\*3 Excluding the FX3UC(D, DSS)

**3) Connection of two or more GOT units**

Up to four GOT-F900 units can be connected to the programming port or the optional communication port of the FX Series PLC.

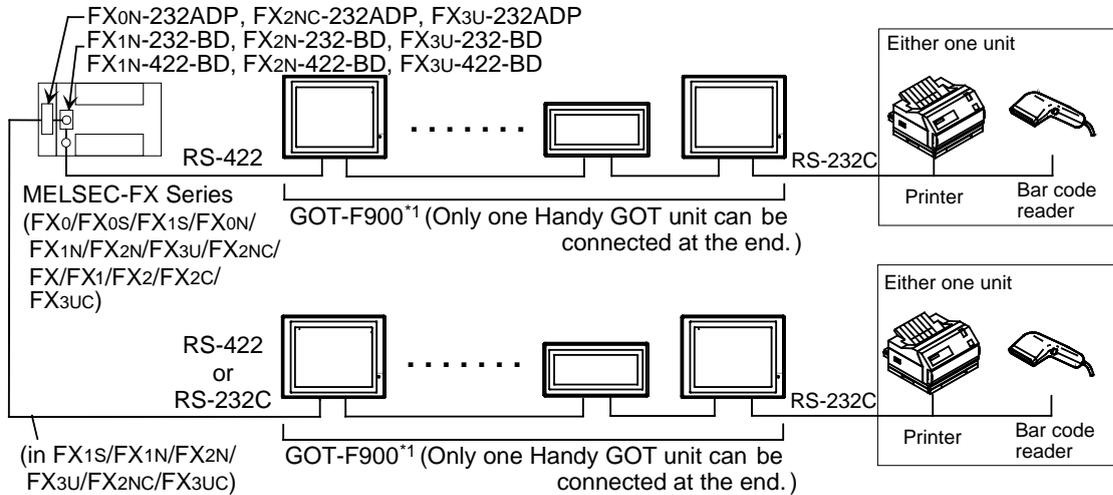

\*1 Excluding the F920GOT-K

**Q/QnA Series PLC**

**1) CPU direct connection (RS-422)**

GOT-F900 is connected to the programming port of the A/QnA Series PLC or the motion controller. When a personal computer is connected to the GOT-F900, programs can be created. The serial communication unit of the Q/QnA Series PLC is connected through CPU direct connection. The GOT-F900 can be connected to only either one between two ports. (Connecting two GOT-F900 units to one serial communication unit is not allowed.) Two GOT-F900 units can be connected at the same time to CH1 and CH2 of the serial communication unit Ver. B or later of the Q Series PLC.

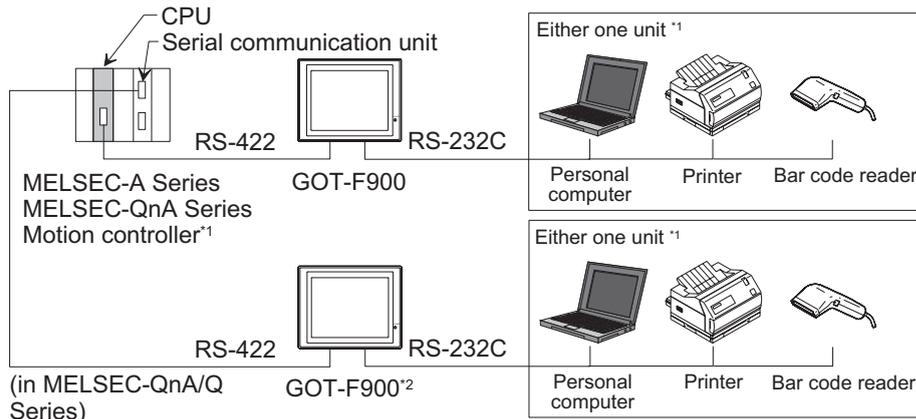

\*1 Excluding the F920GOT-K  
 \*2 Excluding the 5V type F920GOT-K.

**2) CPU direct connection (RS-232C)**

GOT-F900 is connected to the programming port of the Q Series PLC (Multi-CPU system applicable<sup>\*1</sup>) or the serial communication unit of the Q/QnA Series PLC. When a personal computer is connected to the GOT-F900, programs can be created. The serial communication unit of the Q/QnA Series PLC is connected through CPU direct connection. The GOT-F900 can be connected to only either one between two ports. (Connecting two GOT-F900 units to one serial communication unit is not allowed.) (A personal computer, printer or bar code reader can be connected only when the GOT is equipped with two RS-232C channels.)

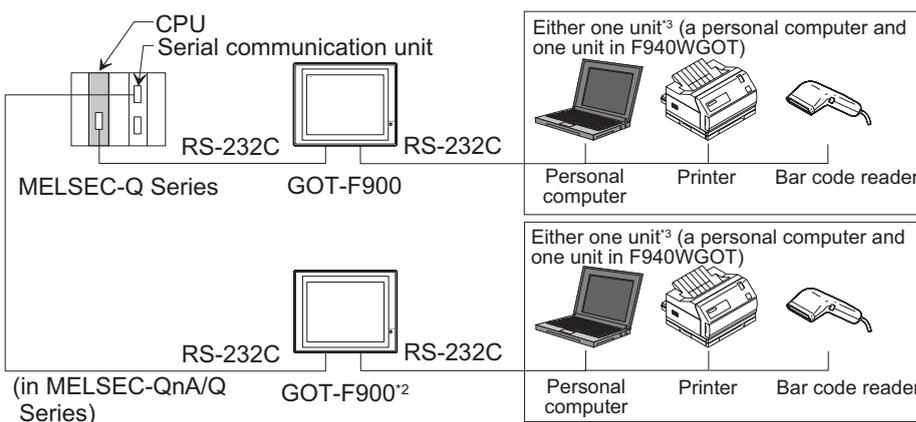

\*1 GOT-F900 can be connected to the multi-CPU system only when the connection consists of QCPU. (A motion controller or CPU of a personal computer cannot be used concurrently.)  
 \*2 Excluding the 5V type F920GOT-K.  
 \*3 Excluding the F920GOT-K

1 Introduction  
 2 Outline  
 3 Specifications  
 4 Installation and Wiring of F940GOT  
 5 Installation and Wiring of Handy GOT  
 6 Connection of Peripheral Equipment  
 7 Connection of Two or More GOT Units  
 8 Connection of MELSEC-FX Series PLC  
 9 Connection of MELSEC-A Series PLC  
 10 Connection of MELSEC-QnA Series PLC

**3) A computer link connection**

GOT-F900 is connected to the A/QnA Series PLC by attaching the A CPU computer link unit.

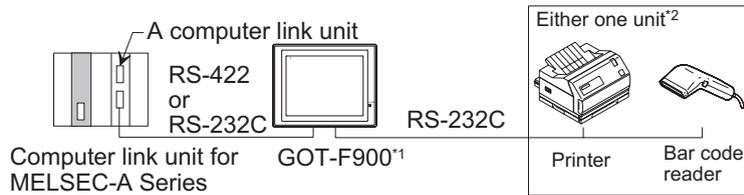

\*1 Excluding the 5V type F920GOT-K.

\*2 Excluding the F920GOT-K.

**4) Connection of two or more GOT units**

In the A/QnA Series PLC, up to four GOT-F900 units can be connected to programming ports (RS-422) of the CPU.

In the QnA/Q Series PLC, to each of the CPU programming port (RS-232C) and the attached serial communication unit, up to four GOT-F900 units can be connected.

The serial communication unit of the Q/QnA Series PLC is connected through CPU direct connection. The GOT-F900 can be connected to only either one between two ports. (Connection of two GOT-F900 units to one serial communication unit is not allowed.)

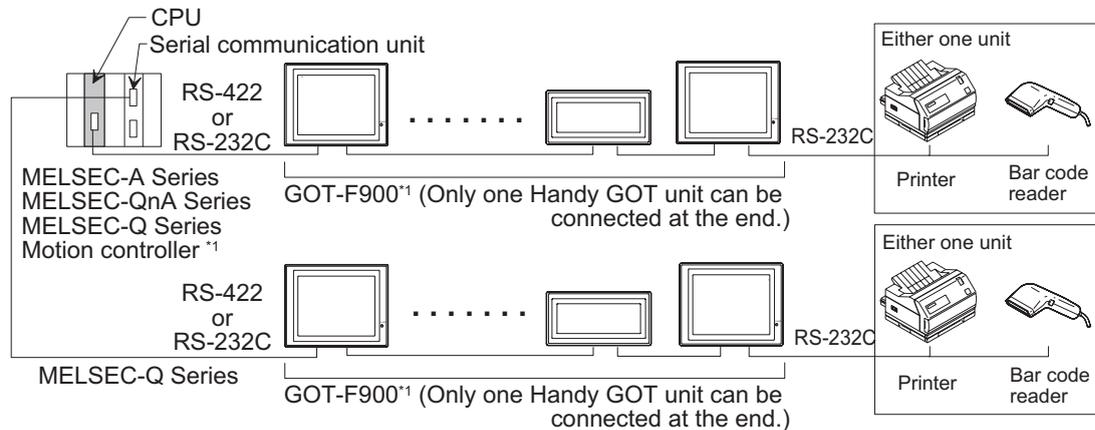

\*1 Excluding the F920GOT-K

**FX positioning unit (10GM/20GM)**

CPU direct connection (RS-422)

GOT-F900 is connected to the programming port of the FX Series positioning unit (10GM/20GM). (A personal computer, printer or bar code reader can be connected only when the GOT is equipped with RS-422 and RS-232C.)

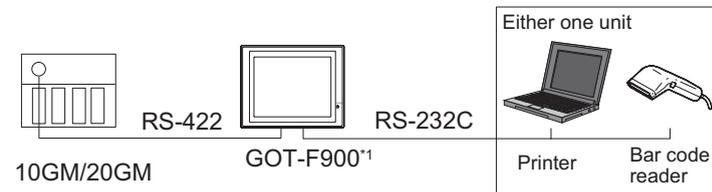

\*1 Excluding the F920GOT-K

**FREQROL Series**

CPU direct connection (RS-422)

GOT-F900 is connected to the (built-in) PU port of the FREQROL Series inverter.  
 In the A500 Series, the GOT-F900 can be connected also to the computer link option (FR-A5NR).

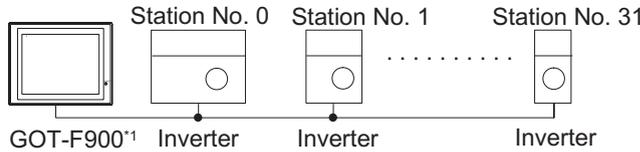

One GOT-F900 unit can control up to 10 inverters.

\*1 Excluding the F920GOT-K

**2.2.2 PLC by Other Companies**

This section describes the outline of connection of the GOT-F900 to the PLC manufactured by other companies.

**General-purpose equipment**

**1) Microcomputer connection**

The GOT-F900 can be connected to the serial communication port of a personal computer or microcomputer board.



\*1 Excluding the 5V type F920GOT-K.

\*2 Excluding the F920GOT-K.

**2) Connection of two or more GOT units**

Up to four GOT-F900 units can be connected to the serial communication connector of a personal computer or microcomputer board.

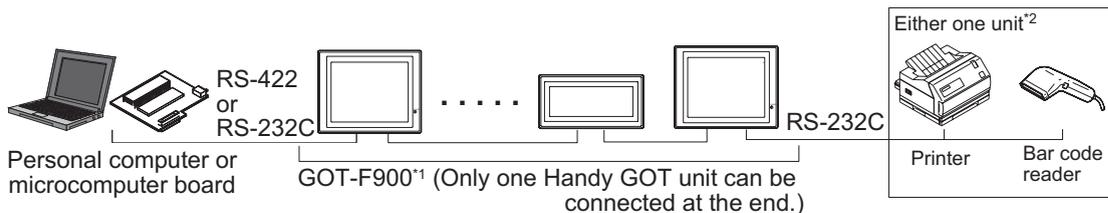

\*1 Excluding the F920GOT-K

\*2 Excluding the F920GOT-K.

**PLC by Omron**

Upper link connection

One GOT-F900 unit can be connected to a port having the upper link communication function of the SYSMAC C Series (C200H/C200HE/C200HG/C200HX/CQM1/CS1/CPM1A/CPM2A/CPM2C/CJ1).

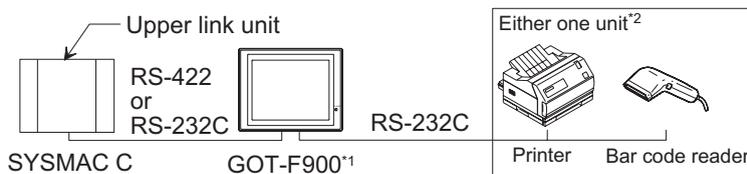

\*1 Excluding the 5V type F920GOT-K.

\*2 Excluding the F920GOT-K.

1 Introduction

2 Outline

3 Specifications

4 Installation and Wiring of F940GOT

5 Installation and Wiring of Handy GOT

6 Connection of Peripheral Equipment

7 Connection of Two or More GOT Units

8 Connection of MELSEC-FX Series PLC

9 Connection of MELSEC-A Series PLC

10 Connection of MELSEC-QnA Series PLC

**PLC by Fuji Electric**

Link unit connection

One GOT-F900 unit can be connected to the link unit of the FLEX-PC N Series (NB/NJ/NS) PLC.

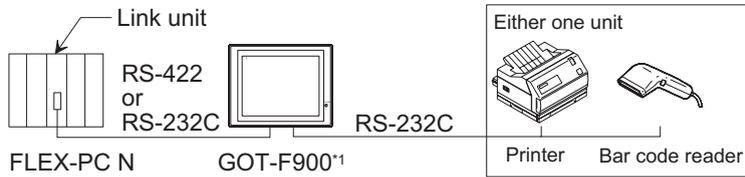

\*1 Excluding the F920GOT-K

**PLC by Yasukawa Electric**

Memo bus unit connection

One GOT-F900 unit can be connected to the MEMOBUS port of the machine controller or the memo bus unit.

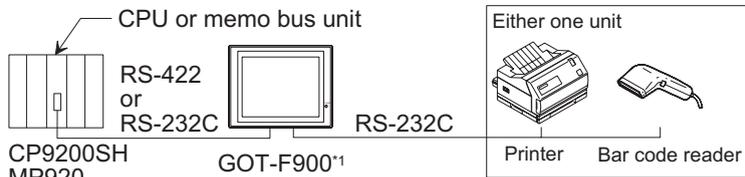

\*1 Excluding the F920GOT-K

**PLC by Matsushita Electric Works**

CPU direct connection (RS-232C)

One GOT-F900 unit can be connected to the FP Series CPU or computer communication unit. (A personal computer, printer or bar code reader can be connected only when the GOT is equipped with two RS-232C channels.)

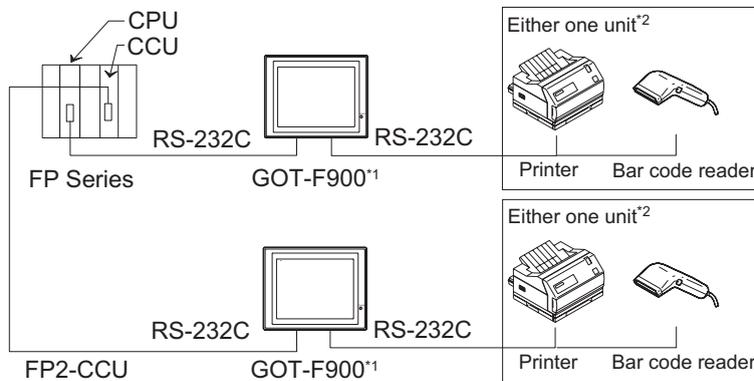

\*1 Excluding the 5V type F920GOT-K.

\*2 Excluding the F920GOT-K.

**PLC by Allen-Bradley**

CPU direct connection (RS-232C)

One GOT-F900 unit can be connected to the SLC500/MicroLogix Series CPU. (A personal computer, printer or bar code reader can be connected only when the GOT is equipped with two RS-232C channels.)

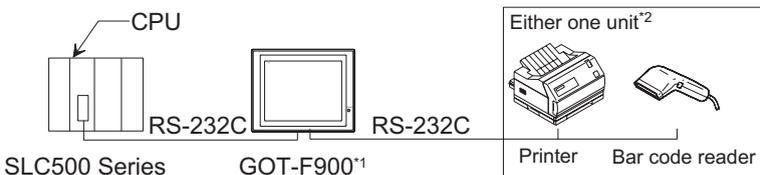

\*1 Excluding the 5V type F920GOT-K.

\*2 Excluding the F920GOT-K.



**PLC by Siemens**

CPU direct connection (RS-232C)

By connecting the HMI adapter to the SIMATIC S7-300/400 Series CPU, one GOT-F900 unit can be connected to the SIMATIC S7-300/400 Series CPU.

By connecting the PC/PPI cable to the SIMATIC S7-200 Series CPU, one GOT-F900 unit can be connected to the SIMATIC S7-200 Series CPU.

(A personal computer, printer or bar code reader can be connected only when the GOT is equipped with two RS-232C channels.)

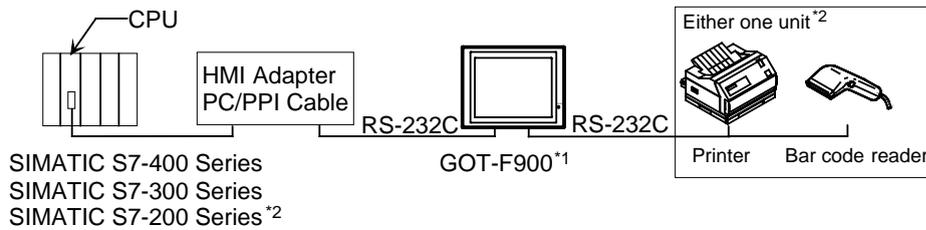

\*1 Excluding the 5V type F920GOT-K.

\*2 Excluding the F920GOT-K.

**2.2.3 Others**

Not only the PLC, a printer or bar code reader can be connected to the GOT-F900.

The connection shown below is available also in the Handy GOT. However, because the rear panel of the Handy GOT must be removed when a cable is connected to the RS-232C connector, the waterproof ability and the operability (operation of the Handy GOT while it is held by hand) are lost. Accordingly, the connection shown below is not practical for the Handy GOT.

**Printer**

Connection of printer (RS-232C)

When a printer is connected to the GOT-F900, the alarms and contents of screens (as hard copy) can be printed.



\*1 Excluding the F920GOT-K and Handy GOT

**Bar code reader**

Connection of bar code reader

When a bar code reader is connected to the GOT-F900, bar codes can be read.

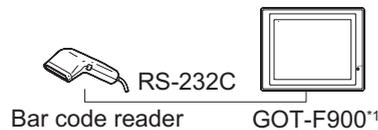

\*1 Excluding the F920GOT-K and Handy GOT

1 Introduction

2 Outline

3 Specifications

4 Installation and Wiring of F940GOT

5 Installation and Wiring of Handy GOT

6 Connection of Peripheral Equipment

7 Connection of Two or More GOT Units

8 Connection of MELSEC-FX Series PLC

9 Connection of MELSEC-A Series PLC

10 Connection of MELSEC-QnA Series PLC

# MEMO

### 3. Specifications

This section allows to confirm connectable equipment, device specifications, versions of applicable screen creation software and hardware specifications.

#### 3.1 OS Version and Correspondence to Connected Equipment of GOT-F900

Some equipment (PLC manufactured by Mitsubishi or other companies, microcomputer board, bar code reader, printer, etc.) cannot be connected depending on the OS (operating system) version of the GOT-F900.

In this section, you can check the OS version, and check whether it corresponds to the equipment to be connected.

##### OS type

There are following five types of OS.

GOT-F900 Series	Name	Remarks
F940WGOT	940W system	
F940GOT, Handy GOT	940 system	
F930GOT	930 system	
F930GOT-K	930 system	The first product is Ver. 4.60 or later.
F920GOT-K	920 system	

##### 3.1.1 How to Confirm OS Version of GOT-F900

When the power of the GOT-F900 is turned on, the screen shown below is displayed for several seconds to indicate the series name and the version number ("version 2.10" in the lower right position). (The period of time to be displayed can be changed by the screen creation software or the GOT.)

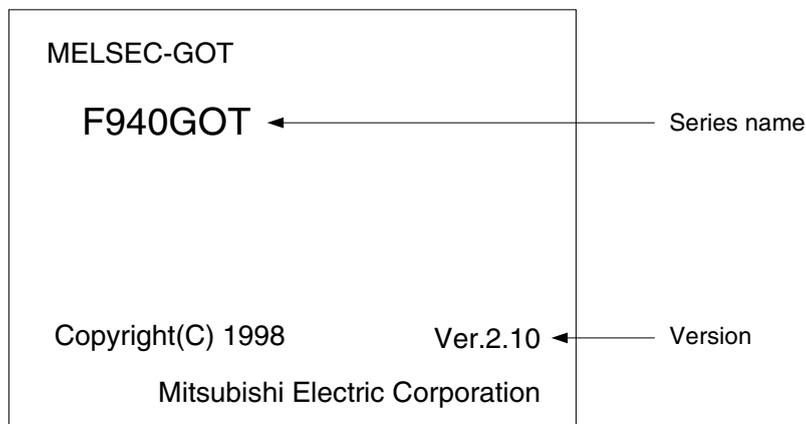

On the rear panel of the GOT-F900 main unit, the nameplate indicating the manufacturer's serial number, the model name and the OS version is adhered. However, because the OS is upgraded, it is recommended to confirm it using the method above.

### 3.1.2 PLC, Positioning unit, Inverter Manufactured by Mitsubishi

The GOT-F900 can be connected to the following equipment in accordance with its OS version. Operations are not assured when the GOT-F900 is connected to any other equipment.

Connected equipment name and series name	RS-232C/ RS-422	OS version				Connection of two or more GOT units	Reference
		940W system	940 system	930 system	920 system		
<b>MITSUBISHI Electric</b>							
<b>MELSEC-F FX Series (CPU direct connection)<sup>*3</sup></b> <b>Connection type name [FXCPU direct connection]</b>							
Connection to programming port in FX CPU							
FX0,FX0S,FX1S,FX0N,FX1N,FX2N,FX3U,FX2NC,FX3NC,FX,FX2C FX2N + FX2N-422-BD FX1S + FX1N-422-BD FX1N + FX1N-422-BD FX3U + FX3U-422-BD FX3UC <sup>*3</sup> + FX3U-422-BD	RS-422	1.00 or later	1.00 or later	1.00 or later	1.00 or later	✓*1	8.2.1
Connection to extended communication port							
FX1S + FX1N-232-BD FX1S + FX1N-CNV-BD + FX0N-232ADP FX1S + FX1N-CNV-BD + FX2NC-232ADP FX1N + FX1N-232-BD FX1N + FX1N-CNV-BD + FX0N-232ADP FX1N + FX1N-CNV-BD + FX2NC-232ADP FX2N + FX2N-232-BD FX2N + FX2N-CNV-BD + FX0N-232ADP FX2N + FX2N-CNV-BD + FX2NC-232ADP FX3U + FX3U-232-BD FX3U + Expansion Boards + FX3U-232ADP FX2NC + FX0N-232ADP FX2NC + FX2NC-232ADP FX3UC <sup>*4</sup> + FX3U-232-BD FX3UC <sup>*4</sup> + Expansion Boards + FX3U-232ADP FX3UC(D, DSS) + FX3U-232ADP	RS-232C	1.00 or later	1.00 or later	1.00 or later	1.20 <sup>*2</sup> or later	✓*1	8.2.2
<b>MELSEC-A Series (CPU direct connection)</b> <b>Connection type name [ACPU direct connection]</b>							
Connection to programming port in A CPU							
AnN, AnA, AnS, AnSJ, AnSH, A1SJH, A2C, A2CJ, A0J2H, AnU, A2US(S1), A2USH, A1FX	RS-422	1.00 or later	1.00 or later	1.00 or later	1.00 or later	✓*1	9.2.1
<b>MELSEC-A Series (computer link connection)</b> <b>Connection type name [A computer link connection]</b>							
Connection to computer link unit							
AJ71UC24, A1SJ71C24-R4, A1SJ71UC24-R4	RS-422	1.00 or later	1.00 or later	1.00 or later	1.20 <sup>*2</sup> or later	—	9.2.2
AJ71UC24, A1SJ71C24-R2, A1SJ71UC24-R2, A1SCPUC24-R2, A2CCPU24	RS-232C						9.2.3
<b>Motion controller (CPU direct connection)</b> <b>Connection type name [ACPU direct connection]</b>							
Connection to programming port in A CPU							
A171SCPU-S3, A171SHCPU, A172SHCPU, A173UHCPU, A273UHCPU	RS-422	1.00 or later	1.00 or later	1.00 or later	1.00 or later	✓*1	9.2.1

Connected equipment name and series name	RS-232C/ RS-422	OS version				Connection of two or more GOT units	Reference
		940W system	940 system	930 system	920 system		
<b>MELSEC-QnA/QnAS Series (CPU direct connection)</b>		<b>Connection type name [QnACPU direct connection]</b>					
Connection to programming port in QnA CPU							
QnACPU, Q4ARCPU, Q2AHCPU, Q2ASCPU, Q2ASH(S1)CPU	RS-422	1.00 or later	3.00 or later	2.00 or later	1.00 or later	✓*1	10.2.1
<b>MELSEC-QnA/QnAS Series (CPU direct connection)</b>		<b>Connection type name [QnA computer link connection]</b>					
Connection to serial communication unit							
AJ71QC24, AJ71QC24-R4, A1SJ71QC24	RS-422	1.00 or later	3.00 or later	2.00 or later	1.20*2	✓*1	10.2.2
AJ71QC24, AJ71QC24-R2, A1SJ71QC24, A1SJ71QC24-R2	RS-232C						10.2.3
<b>MELSEC-QnA/QnAS Series (computer link connection)</b>		<b>Connection type name [A computer link connection]</b>					
Connection to computer link unit							
AJ71UC24, A1SJ71C24-R4, A1SJ71UC24-R4	RS-422	1.00 or later	3.00 or later	2.00 or later	1.20*2	—	9.2.2
AJ71UC24, A1SJ71C24-R2, A1SJ71UC24-R2	RS-232C						9.2.3
<b>MELSEC-Q Series (CPU direct connection)</b>		<b>Connection type name [QCPU direct connection]</b>					
<b>Connection to QnU CPU is not allowed.</b>							
Connection to programming port in Q CPU							
Q02CPU, Q02HCPU, Q06HCPU, Q12HCPU, Q25HCPU	RS-232C	1.00 or later	4.10 or later	2.20 or later	1.00 or later	✓*1	11.2.1
Q00JCPU, Q00CPU, Q01CPU	RS-232C	1.30 or later	6.30 or later	4.30 or later	1.00 or later	✓*1	11.2.1
<b>MELSEC-Q Series (CPU direct connection)</b>		<b>Connection type name [QCPU direct connection]</b>					
<b>Connection to QnU CPU is not allowed.</b>							
Connection to serial communication unit							
QJ71C24N	RS-422	1.92 or later	6.91 or later	4.92 or later	1.30*2	—	11.2.2
	RS-232C						11.2.3
QJ71C24	RS-422	1.00 or later	4.10 or later	2.20 or later	1.20*2	—	11.2.2
QJ71C24, QJ71C24-R2	RS-232C						11.2.3
<b>MELSEC-Q Series (CPU direct connection) (Q multiple PLC system Ver. B or later)</b>		<b>Connection type name [QCPU direct connection]</b>					
<b>Connection to QnU CPU is not allowed.</b>							
Connection to programming port in Q CPU							
Q02CPU, Q02HCPU, Q06HCPU, Q12HCPU, Q25HCPU	RS-232C	1.30 or later	6.30 or later	4.30 or later	1.00 or later	✓*1	11.2.1
Connection to serial communication unit							
QJ71C24N	RS-422	1.92 or later	6.91 or later	4.92 or later	1.30*2	—	11.2.2
	RS-232C						11.2.3
QJ71C24	RS-422	1.30 or later	6.30 or later	4.30 or later	1.20*2	—	11.2.2
QJ71C24, QJ71C24-R2	RS-232C						11.2.3
<b>FX Series positioning unit (CPU direct connection)</b>		<b>Connection type name [GM direct connection]</b>					
Connection to programming port in GM CPU							
FX2N-10GM, FX2N-20GM, FX-10GM, FX-20GM, E-20GM	RS-422	1.10 or later	6.10 or later	4.10 or later	—	—	12.2.1

Connected equipment name and series name	RS-232C/ RS-422	OS version				Connection of two or more GOT units	Reference
		940W system	940 system	930 system	920 system		
<b>FREQROL Series inverter (CPU direct connection)</b>		<b>Connection type name [INV direct connection]</b>					
Connection to computer link (PU port, etc.)							
S500 Series (RS-485 port built-in type only) A500 Series (PU port, FR-A5NR) E500 Series (PU port)	RS-422	1.10 or later	6.10 or later	4.10 or later	—	—	13.2.1

✓: Can connect    —: Cannot connect

\*1 Excluding the 920 system

\*2 Excluding the 5 V type F920GOT-K.

\*3 Applicable ranges of the FX<sub>3U</sub>/FX<sub>3UC</sub> Series PLC are limited to function ranges provided in the FX<sub>2N</sub>/FX<sub>2NC</sub> Series PLC such as instruction and device ranges and program size.

Do not use the following functions in the HPP mode when the GOT-F900 is connected to the FX<sub>3U</sub>/FX<sub>3UC</sub> Series PLC:

- Program list
- Parameter
- List monitor

\*4 Excluding the FX<sub>3UC</sub>(D, DSS)

### 3.1.3 PLC Manufactured by Other Companies

The GOT-F900 can be connected to the following equipment in accordance with its OS version. Operations are not assured when the GOT-F900 is connected to any other equipment.

Connected equipment name and series name	RS-232C/ RS-422	OS version				Connection of two or more GOT units	Reference
		940W system	940 system	930 system	920 system		
<b>General</b>							
<b>Microcomputer (general-purpose communication) Connection type name [Micro computer connection]</b>							
Connection to serial communication port							
Personal computer or microcomputer board equipped with RS-232C or RS-422 interface	RS-422	1.00 or later	1.00 or later	1.00 or later	1.20*2 or later	✓*1	14.2.1
	RS-232C						14.2.2
<b>Omron</b>							
<b>SYSMAC COM1/C200H Series (upper link) Connection type name [SYSMAC C]</b>							
Connection to RS-232C port built in CPU							
CQM1 (built-in upper link) - CQM1-CPU21	RS-232C	1.00 or later	1.00 or later	1.00 or later	1.20*2 or later	—	15.2.2
CQM1H (built-in upper link) - CQM1H-CPU61	RS-232C	1.40 or later	6.40 or later	4.40 or later	1.20*2 or later	—	15.2.2
Connection to host link unit							
C200H/C200HS - C200H-CPU01 + C200H-LK202-V1 - C200HS-CPU31 + C200H-LK202-V1	RS-422	1.00 or later	1.00 or later	1.00 or later	1.20*2 or later	—	15.2.1
C200H/C200HS - C200H-CPU01 + C200H-LK201-V1 - C200HS-CPU31 + C200H-LK201-V1	RS-232C						15.2.2
<b>SYSMAC CS1 Series (upper link) Connection type name [SYSMAC C]</b>							
Connection to RS-232C port built in CPU							
CS1G-CPU45-V1	RS-232C	1.00 or later	6.00 or later	4.00 or later	1.20*2 or later	—	15.2.2
Connection to serial communication board/unit							
CS1W-SCB41 (port 1, port 2)	RS-422	1.00 or later	6.00 or later	4.00 or later	1.20*2 or later	—	15.2.1
	RS-232C						15.2.2
CS1W-SCU21 (port 1, port 2)	RS-232C						15.2.2
<b>SYSMAC α Series (upper link) Connection type name [SYSMAC C]</b>							
Connection to RS-232C port built in CPU							
C200HX-CPU44-Z	RS-232C	1.62 or later	6.62 or later	4.62 or later	1.20*2 or later	—	15.2.2
Connection to serial communication board							
C200HW-COM06-V1 (port A, port B)	RS-422	1.62 or later	6.62 or later	4.62 or later	1.20*2 or later	—	15.2.1
	RS-232C						15.2.2
<b>SYSMAC CPM 1A/2A/2C Series (upper link) Connection type name [SYSMAC C]</b>							
Connection to peripheral port built in CPU							
CPM1A-10CDR-A + CQM1-CIF01 (Level conversion of peripherique port) + Conversion connector [25pin → 9pin] CPM2C-10CDR-D + CPM2C-CIF01-V1 (RS232C et port peripherique) CPM2C-10CDR-D + CPM2C-CN111	RS-232C	1.62 or later	6.62 or later	4.62 or later	1.20*2 or later	—	15.2.1
Connection to RS-232C port built in CPU							
CPM2A-30CDR-A	RS-232C	1.62 or later	6.62 or later	4.62 or later	1.20*2 or later	—	15.2.2

Connected equipment name and series name	RS-232C/ RS-422	OS version				Connection of two or more GOT units	Reference
		940W system	940 system	930 system	920 system		
<b>SYSMAC CJ1 Series (upper link)</b>		<b>Connection type name [SYSMAC C]</b>					
Connection to RS-232C port built in CPU							
CJ1G-CPU44	RS-232C	1.62 or later	6.62 or later	4.62 or later	1.20*2 or later	—	15.2.2
Connection to serial communicatin board							
CJ1M-CPU12 + CJ1W-SCU41	RS-422	1.62 or later	6.62 or later	4.62 or later	1.20*2 or later	—	15.2.1
CJ1G-CPU44 + CJ1W-SCU41	RS-232C						15.2.2
<b>Fuji Electric</b>							
<b>FLEX-PC N Series (link unit)</b>		<b>Connection type name [FLEX-PC N]</b>					
Connection to RS-232C port built in CPU							
NJ Series - NJ-CPU-B16	RS-232C	1.00 or later	1.00 or later	1.00 or later	—	—	16.2.2
Connection to link unit							
NB Series - NB-RS1-AC NJ Series - NJ-RS4 NS Series - NS-RS1	RS-422	1.00 or later	1.00 or later	1.00 or later	—	—	16.2.1
NB Series - NB-RS1-AC NJ Series - NJ-RS2 NS Series - NS-RS1	RS-232C						16.2.2
<b>Yasukawa Electric</b>							
<b>Machine controller (memo bus connection)</b>		<b>Connection type name [Machine controller]</b>					
Connection to RS-232C port built in CPU							
MP920, MP930	RS-232C	1.00 or later	5.00 or later	3.00 or later	—	—	17.2.1
Connection to memo bus unit							
MP920 + CP-217IF	RS-422	1.00 or later	5.00 or later	3.00 or later	—	—	17.2.1
CP9200SH + CP-217IF	RS-232C						17.2.2
<b>Matsushita Electric Works</b>							
<b>FP Series (CPU direct connection)</b>		<b>Connection type name [FP]</b>					
Connection to COM port built in CPU							
FP0 Series - FP0-T32CT FP2SH Series - FP2-C2	RS-232C	1.10 or later	6.10 or later	4.10 or later	1.20*2 or later	—	18.2.1
Connection to tool port built in CPU							
FP0 Series - FP0-T32CT FP2SH Series - FP2-C2	RS-232C	1.10 or later	6.10 or later	4.10 or later	1.20*2 or later	—	18.2.1
Connection to COM port for communication with computer							
FP2SH Series - FP2-C2 + FP2-CCU	RS-232C	1.10 or later	6.10 or later	4.10 or later	1.20*2 or later	—	18.2.1



Connected equipment name and series name	RS-232C/ RS-422	OS version				Connection of two or more GOT units	Reference
		940W system	940 system	930 system	920 system		
<b>FPΣ Series (CPU direct connection)</b>		<b>Connection type name [FP]</b>					
Connection to tool port built in CPU							
FPG-C32T	RS-232C	1.62 or later	6.62 or later	4.62 or later	1.20*2 or later	—	
Connection to COM port for communication with computer							
FPG-C32T + FPG-COM1 (port 1) FPG-C32T + FPG-COM2 (port 1, port 2)	RS-232C	1.62 or later	6.62 or later	4.62 or later	1.20*2 or later	—	
<b>Allen-Bradly</b>							
<b>SLC500 Series (CPU direct connection)</b>		<b>Connection type name [SLC500]</b>					
Connection to port built in CPU							
SLC5/03 SLC5/04	RS-232C	1.00 or later	2.00 or later	2.00 or later	1.20*2 or later	—	19.2.1
<b>MicroLogix Series (CPU direct connection)</b>		<b>Connection type name [SLC500]</b>					
Connection to port built in CPU							
MicroLogix 1000 (D Series and later) Micro Logix 1000 analog Micro Logix 1200 Micro Logix 1500	RS-232C	1.00 or later	6.00 or later	4.00 or later	1.20*2 or later	—	19.2.1
<b>SIEMENS AG</b>							
<b>SIMATIC S7-300/400 Series (CPU direct connection)</b>		<b>SIMATIC S7 Series (SIMATIC S7)</b>					
Connection to port built in CPU							
S7-300 Series - S7-312IFM, 313, 314, 314IFM, 315-2DP, 316 + HMI adapter (6ES7 972-0CA11-0XA0) S7-400 Series - S7-412-1, 413-1, 413-2DP, 414-1, 414-2DP, 416-1, 416-2DP + HMI adapter (6ES7 972-0CA11-0XA0)	RS-232C	1.00 or later	5.00 or later	3.00 or later	1.20*2 or later	—	20.2.1
<b>SIMATIC S7-200 Series (CPU direct connection)</b>		<b>SIMATIC S7 Series (SIMATIC S7)</b>					
Connection to port built in CPU							
S7-200 Series - S7-212, 214, 215, 216, 221, 222, 224 + PC/PPI cable (6ES7 901-3BF20-0ZA0)	RS-232C	1.20 or later	6.20 or later	4.20 or later	—	—	20.2.1

✓: Can connect —: Cannot connect

\*1 Excluding the 920 system

\*2 Excluding the 5 V type F920GOT-K.

1	Introduction
2	Outline
3	Specifications
4	Installation and Wiring of F940GOT
5	Installation and Wiring of Handy GOT
6	Connection of Peripheral Equipment
7	Connection of Two or More GOT Units
8	Connection of MELSEC-FX Series PLC
9	Connection of MELSEC-A Series PLC
10	Connection of MELSEC-QnA Series PLC

### 3.1.4 Others

The GOT-F900 can be connected to the following equipment in accordance with its OS version.  
The table below describes the product evaluated in each series.

Connected equipment name and series name	RS-232C/ RS-422	OS version				Connection of two or more GOT units	Reference
		940W system	940 system	930 system	920 system		
<b>General</b>							
<b>General-purpose printer for RS-232C</b>		<b>SIMATIC S7 Series (RS-232C general-purpose printer)</b>					
Connection to RS-232C port							
Connection to ESC/P compatible printer equipped with built-in RS-232C interface LBP450 (laser printer for A4 size) [Cannon] LP8000SX (laser printer for A4 size) [EPSON]	RS-232C	1.00 or later	1.00 or later	1.00 <sup>*1</sup> or later	—	—	21.2.1
<b>Bar code reader</b>		<b>SIMATIC S7 Series (Bar code reader)</b>					
Connection to RS-232C port							
BCH5432-STA [Nihon Denki Seiki]	RS-232C	1.00 or later	2.00 or later	2.00 or later	—	—	21.2.1

✓: Can connect    —: Cannot connect

\*1 Only the alarm history can be printed in the 930 system.

## 3.2 Version of Screen Creation Software and Correspondence to GOT-F900

Three types of screen creation software are offered the SW□D5C-GTD2-E, SW□D5C-GOTR-PACKE and FX-PCS-DU/WIN-E as follows.

### Types of screen creation software

Screen creation software	Name	Generic name
SW□D5C-GTWK2-E SW□D5C-GTD2-E	GT Designer2	Screen creation software
SW□D5C-GTWORKS-E SW□D5C-GOTR-PACKE	GT Designer	
FX-PCS-DU/WIN-E	DU/WIN	

Applicable GOT-F900 Series models and the correspondence to the connected equipment (related to the OS version also) vary depending on the version of the screen creation software. In this section, you can check the version of your screen creation software and confirm applicable GOT models and connectable equipment.

The table in Section 3.2.2 shows the screen creation software version corresponding to each GOT-F900. The table in Section 3.2.3 shows the screen creation software version corresponding to each connected equipment. Compare these two tables. The newer version is required.

1

Introduction

2

Outline

3

Specifications

4

Installation  
and Wiring of  
F940GOT

5

Installation  
and Wiring of  
Handy GOT

6

Connection of  
Peripheral  
Equipment

7

Connection of  
Two or More  
GOT Units

8

Connection of  
MELSEC-F FX  
Series PLC

9

Connection of  
MELSEC-A  
Series PLC

10

Connection of  
MELSEC-QnA  
Series PLC

### 3.2.1 How to Conform Version of Screen Creation Software

You can confirm the version by displaying the help screen after starting up the screen creation software in the personal computer or by confirming the contents indicated on the FD or CD-ROM of the product.

#### 1) When confirming the version using the help function of the software

For the GT Designer2, GT Designer and DU/WIN, you can confirm the version by selecting [Help (H)]-[About (A)] from the menu bar.

##### a) GT Designer2

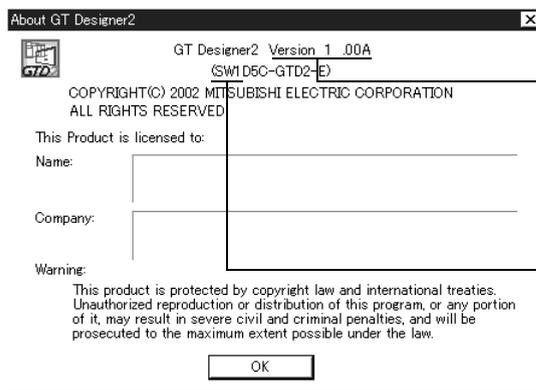

Version ("1.00A" in this case)

"SW1" indicates the major version.

SW□D5C-GTD2-J (Japanese)

SW□D5C-GTD2-E (English)

##### b) GT Designer

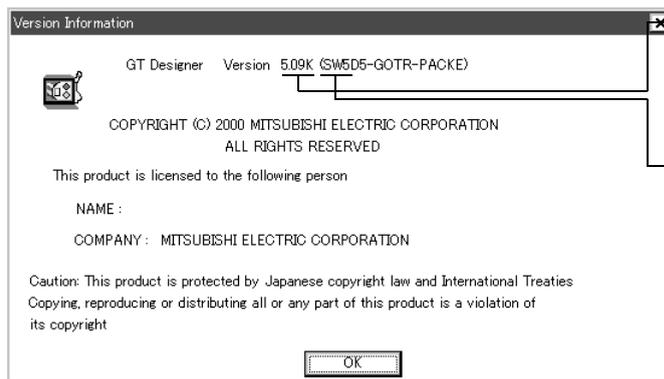

In the case of Version SW5 or later

Version 5.09K

Small version

SW5

SW□D5C-GOTR-PACKE

"SW5" indicates the large version. An alphabet at the end indicates the small version.

In the case of Version SW4 or former

An alphabet at the end indicates the small version.

Version SW□ 00A

Small version

##### c) DU/WIN

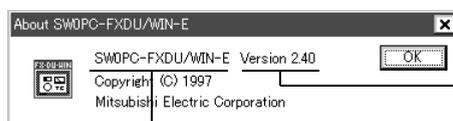

Version

Model name

2) When confirming the version through the contents indicated on the media

You can confirm the version by checking the contents indicated on the media of the product.

a) GT Designer2 (CD-ROM)

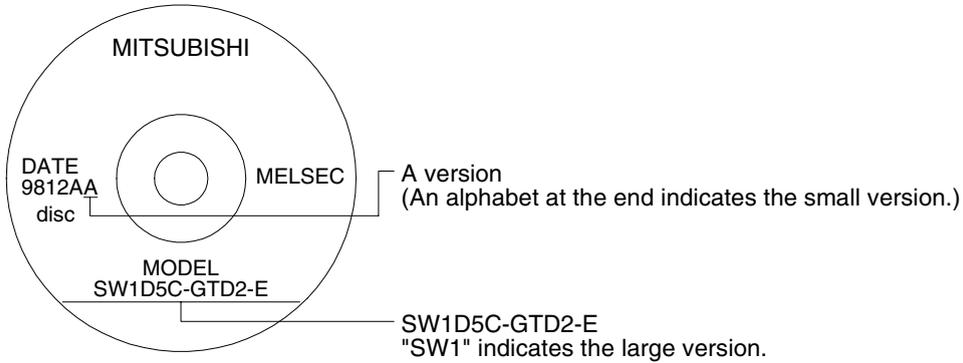

b) GT Designer (CD-ROM)

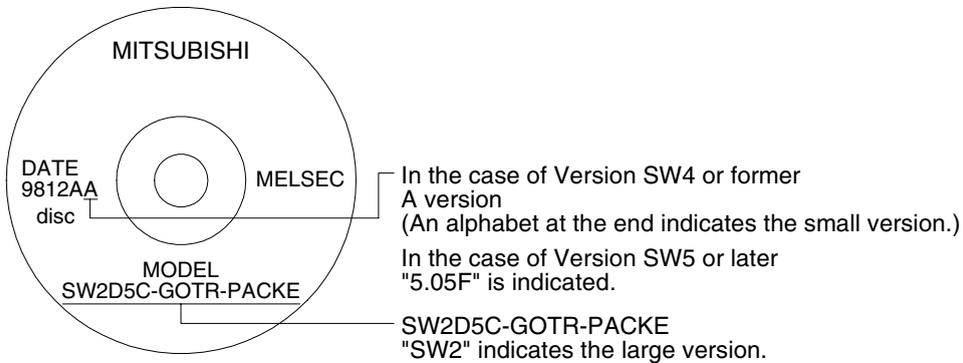

c) DU/WIN (FD)

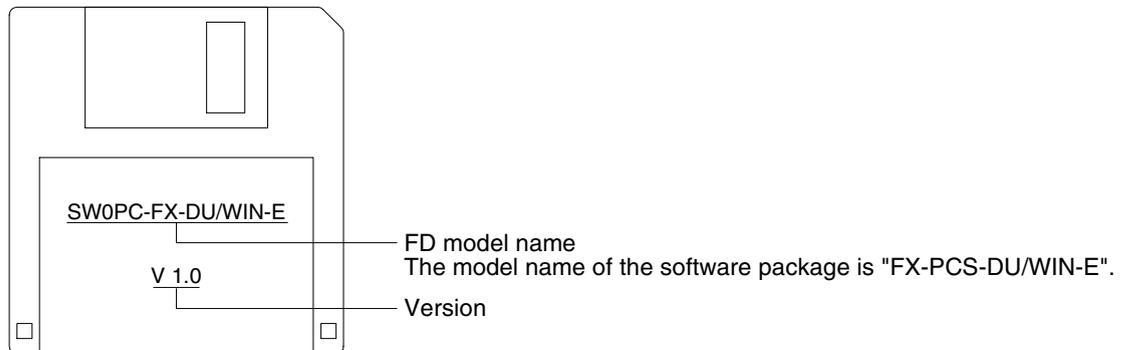

1	Introduction
2	Outline
3	Specifications
4	Installation and Wiring of F940GOT
5	Installation and Wiring of Handy GOT
6	Connection of Peripheral Equipment
7	Connection of Two or More GOT Units
8	Connection of MELSEC-F FX Series PLC
9	Connection of MELSEC-A Series PLC
10	Connection of MELSEC-QnA Series PLC

### 3.2.2 Screen Creation Software Version Corresponding to GOT-F900 Series

#### Japanese version

GOT-F900 Series	SW□D5C-GTD2-J Version	SW□D5C-GOTR-PACK Version	FX-PCS-DU/WIN Version
F940WGOT	SW1-A (1.00A)	SW5-F (5.05F)	2.50
F940GOT	SW1-A (1.00A)	SW1-A	2.00
F943GOT	SW1-A (1.00A)	SW1-A	2.00
F930GOT-K	SW1-A (1.00A)	SW5-26C (5.26C)	–
F930GOT	SW1-A (1.00A)	SW1-H	2.20
F933GOT	SW1-A (1.00A)	SW1-H	2.20
F920GOT-K (5V)	SW1-A (1.00A)	SW5-26C (5.26C)	2.70
F920GOT-K (24V)	SW1-C (1.02C)	–	–
F940 Handy GOT	SW1-A (1.00A)	SW1-D	2.10
F940 Handy GOT (RH model)	SW1-A (1.00A)	SW5-F (5.05F)	2.50
F943 Handy GOT	SW1-A (1.00A)	SW1-D	2.10
F943 Handy GOT (RH model)	SW1-A (1.00A)	SW5-F (5.05F)	2.50
F920 Handy GOT (RH model)	SW1-F (1.05F)	–	–
ET-900	SW1-A (1.00A)	SW1-D	2.00

- "□" of the "SW□D5C-GOTRE-PACKE" and "SW□DC-GTD2-E" indicates a number.

#### English version

GOT-F900 Series	SW□D5C-GTD2-E	SW□D5C-GOTRE-PACK Version	FX-PCS-DU/WIN-E Version
F940WGOT	SW1-C (1.02C)	SW5-F (5.05F)	2.50
F940GOT	SW1-C (1.02C)	SW1-E	2.00
F930GOT-K	SW1-C (1.02C)	SW5-26C (5.26C)	2.70
F930GOT	SW1-C (1.02C)	SW1-H	2.30
F920GOT-K (5V)	SW1-C (1.02C)	SW5-26C (5.26C)	2.70
F920GOT-K (24V)	SW1-C (1.02C)	–	–
F940 Handy GOT	SW1-C (1.02C)	SW1-D	2.10
F940 Handy GOT (RH model)	SW1-C (1.02C)	SW5-F (5.05F)	2.50
F943 Handy GOT	SW1-C (1.02C)	SW1-D	2.10
F943 Handy GOT (RH model)	SW1-C (1.02C)	SW5-F (5.05F)	2.50

- "□" of the "SW□D5C-GOTRE-PACKE" and "SW□DC-GTD2-E" indicates a number.

### 3.2.3 Screen Creation Software Corresponding to Each Connected Equipment

#### Products in Japanese

Connected equipment (abbreviation)	SW□D5C-GTD2-J Version	SW□D5C-GOTR-PACK Version	FX-PCS-DU/WIN Version
<b>Mitsubishi</b>			
FXCPU direct connection	SW1-A (1.00A)	SW1-A	2.00
ACPU direct connection			
A computer link			
QnACPU direct connection	SW1-A (1.00A)	SW2-A	2.30
QnA computer link			
QCPU direct connection	SW1-A (1.00A)	SW4-F	2.40
Q computer link			
QCPU direct connection (multi CPU system)	SW1-A (1.00A)	SW5-P (5.13P)	-
Q computer link (multi CPU system)			
GM direct connection (FX positioning unit)	SW1-A (1.00A)	SW5-K (5.09K)	2.50
INV direct connection (inverter)			
<b>Other companies</b>			
Microcomputer connection (general-purpose communication)	SW1-A (1.00A)	SW1-A	2.00
SYSMAC C by Omron	SW1-A (1.00A)	SW1-A	
FLEX-PC N by Fuji Electric	SW1-A (1.00A)	--(Not applicable)	
CP9200SH by Yasukawa Electric	SW1-A (1.00A)	SW4-F	--(Not applicable)
FP by Matsushita Electric Works	SW1-A (1.00A)	SW5-K (5.09K)	2.60
SLC500 by Allen-Bradley	SW1-A (1.00A)	SW1-H	2.30
MicroLogix by Allen-Bradley	SW1-A (1.00A)	SW5-F (5.05F)	2.50
SIMATIC S7-400 by Siemens AG	SW1-A (1.00A)	SW5-F (5.05F)	2.40
SIMATIC S7-300 by Siemens AG	SW1-A (1.00A)	SW5-F (5.05F)	2.40
SIMATIC S7-200 by Siemens AG	SW1-A (1.00A)	SW5-P (5.13P)	2.60
<b>Others</b>			
Printer (with built-in RS-232C)	SW1-A (1.00A)	SW1-A	2.00
Bar code reader	SW1-A (1.00A)	SW1-H	2.20 <sup>*1</sup>
CC-Link	SW1-A (1.00A)	SW5-P (5.13P)	2.40

- "□" of the "SW□D5C-GOTRE-PACKE" and "SW□DC-GTD2-E" indicates a number.

\*1 The F930GOT is applicable in Version 2.30 and later.

## Products in English

Connected equipment (abbreviation)	SW□D5C-GTD2-E	SW□D5C-GOTR-PACKE Version	FX-PCS-DU/WIN-E Version
<b>Mitsubishi</b>			
FXCPU direct connection	SW1-C (1.02C)	SW1-E	2.00
ACPU direct connection	SW1-C (1.02C)		
A computer link	SW1-C (1.02C)		
QnACPU direct connection	SW1-C (1.02C)	SW2-A	2.30
QnA computer link	SW1-C (1.02C)		
QCPU direct connection	SW1-C (1.02C)	SW4-F	2.40
Q computer link	SW1-C (1.02C)		
QCPU direct connection (multi CPU system)	SW1-C (1.02C)	SW5-P (5.13P)	-
Q computer link (multi CPU system)	SW1-C (1.02C)		
GM direct connection (FX positioning unit)	SW1-C (1.02C)	SW5-K (5.09K)	2.50
INV direct connection (inverter)	SW1-C (1.02C)		
<b>Other companies</b>			
Microcomputer connection (general-purpose communication)	SW1-C (1.02C)	SW1-E	2.00
SYSMAC C by Omron	SW1-C (1.02C)		
FLEX-PC N by Fuji Electric	SW1-C (1.02C)	Not applicable	
CP9200SH by Yasukawa Electric	SW1-C (1.02C)	SW4-F	-
FP by Matsushita Electric Works	SW1-C (1.02C)	SW5-K (5.09K)	2.60
SLC500 by Allen-Bradley	SW1-C (1.02C)	SW1-H	2.30
MicroLogix by Allen-Bradley	SW1-C (1.02C)	SW5-F (5.05F)	2.50
SIMATIC S7-400 by Siemens AG	SW1-C (1.02C)	SW5-F (5.05F)	2.40
SIMATIC S7-300 by Siemens AG	SW1-C (1.02C)	SW5-F (5.05F)	2.40
SIMATIC S7-200 by Siemens AG	SW1-C (1.02C)	SW5-P (5.13P)	2.52
<b>Others</b>			
Printer (with built-in RS-232C)	SW1-C (1.02C)	SW1-E	2.00
Bar code reader	SW1-C (1.02C)	SW1-H	2.30

- "□" of the "SW□D5C-GOTRE-PACKE" and "SW□DC-GTD2-E" indicates a number.



### 3.3 Device Names Which can be Monitored

This section explains the device range of the PLC available in the GOT-F900. The maximum device range which can be set in the screen creation software is shown here. The device specifications vary depending on the model of the PLC even if the series name is equivalent. (Example: In the FX Series, the FX1N PLC has fewer devices than in the FX2N PLC.)

When looking at the table, change the device range shown in the table with the device range available in the actually connected PLC.

#### 3.3.1 Devices in GOT-F900

The table below shows intrinsic devices built in the GOT-F900.

Because these internal devices have no relevance to the devices in the connected PLC or the memory of the microcomputer board, they can be used without regard to the connected equipment.

These internal devices in the GOT-F900 can be rewritten by the status monitoring function, the switch function and the numeric value input function, and used for lamp indicator, numeric value display, switch condition, etc.

#### Available screen creation software

GT Designer2 and GT Designer from the first version  
DU/WIN from Version 2.50 and later

#### Allocation of devices for internal processing

Device name		Available range		Device number representation
Bit device	GB (GOT internal device)	GB0 to GB131	Not available except devices in table below	Decimal
		GB132 to GB255	Available	
		GB256 to GB1023	Available (excluding the F920GOT-K)	
Word device	GD (GOT internal device)	GD0 to GD99	Not available except devices in table below	Decimal
		GD100 to GD127	Available	
		GD128 to GD1023	Available (excluding the F920GOT-K)	

- GB 0 to GB 131 and GD 0 to GD 99 are used for the processing inside the GOT-F900.  
Note, however, that the devices with functions shown below are available for user use.

Device	Function
GD0	Display of current time (second)*2
GD1	Display of current time (minute)*2
GD2	Display of current time (hour)*2
GD3	Display of current time (day)*2
GD4	Display of current time (month)*2
GD5	Display of current time (year)*2
GD6	Display of current time (day of week)*2
GD7	Not to be used
GD8,GD9	Upper limit of input numerical value (32 bit)
GD10,GD11	Lower limit of input numerical value (32 bit)
GD12	Numerical value, Ascii input
GD13 to GD99	Not to be used
GD100 to GD1023	For user's use

\*2 Which cannot be input or changed

Device	Function
GB0 to GB12	Not to be used
GB13	Communication error
GB14,GB15	Not to be used
GB16	Buzzer (Issued once) *1
GB17	Buzzer (Issued three times) *1
GB18	Buzzer (Issued continuously) *1
GB19 to 131	Not to be used
GB132 to GB1023	For user's use

\*1 Buzzer is available in the following OS.

- F940WGOT Ver. 1.40 or later
- F940GOT Ver. 6.40 or later
- F930GOT Ver. 4.40 or later
- F930GOT-K Ver. 4.60 or later (From first product)
- F920GOT-K Ver. 1.00 or later (From first product)
- Handy GOT Ver. 6.40 or later

- 1 Introduction
- 2 Outline
- 3 Specifications
- 4 Installation and Wiring of F940GOT
- 5 Installation and Wiring of Handy GOT
- 6 Connection of Peripheral Equipment
- 7 Connection of Two or More GOT Units
- 8 Connection of MELSEC-F Series PLC
- 9 Connection of MELSEC-A Series PLC
- 10 Connection of MELSEC-QnA Series PLC

3.3.2 PLC by Mitsubishi

1) MELSEC-F FX Series

Device name			Setting range		Device number representation
			GT Designer (2)	DU/WIN	
Bit device	Input (X)		X000~X377	X000~X377	Octal
	Output (Y)		Y000~Y377	X000~X377	
	Auxiliary relay (M)		M0000~M3071	M0000~M3071	Decimal
	Special auxiliary relay (M)		M8000~M8255	M8000~M8255	
	State (S)		S0~S999	S0~S999	
	Timer contact (T)		T0~T255	T0~T255	
	Counter contact (C)		C000~C255	C0~C255	
	GOT internal bit register (GB) *1		GB132~GB1023	GB132~GB1023	
Word device	Timer (T)		Present value	T0~T255	T0~T255
			Set value *2	TS0~TS255	-
	Counter (C)	16 bits	Present value	C0~C199	C0~C199
			Set value *2	CS0~CS199	
		32 bits	Present value	C200~C255	C200~C255
			Set value *2	CS200~CS255	
	Data register (D) (Including file register*2)		D0~D7999	D0~D7999	
	File register (D)		D1000~D7999	D1000~D7999	
	Special data register (D)		D8000~D8255	D8000~D8255	
	Index register		Z *3	Z	
			V *3	V	
GOT internal data register (GD) *1		GD100~GD1023	GD100~GD1023		

- Applicable ranges of the FX3U/FX3UC Series PLC are limited to device ranges provided in the FX2N/FX2NC Series PLC.

- In specifying word devices for the bar code reader, C200 to C255 and CS200 to CS255 are not available.

\*1 GB132 to GB255 and GD100 to GD127 in the F920GOT-K

\*2 In data changes, the condition shown below is present.

Condition enabling data changes  
 While the GOT is connected to the FX Series PLC, data cannot be changed in set values (specified directly) of timers and counters and file registers in the following condition.

PLC status		While PLC is stopped			While PLC is running		
Memory cassette attached to PLC	Memory type	RAM	EEPROM	EPROM	RAM	EEPROM	EPROM
	Write-protect switch status	-	OFF	ON	-	OFF	ON
Entry code	Present	✓	✓	x*1	✓	x*3	x*1
	Not present	x*2			x*2		

The following error messages are displayed on the screen only when a timer, counter or file register is accessed through a Numeric Input or ASCII input.

\*1 When data of a set value (specified directly) of a timer or counter is tried to be changed, the error message "WRITE IS PROHIBITED." is displayed. (Set values of timers and counters can be changed if they are specified indirectly using data registers.)  
 When data of a file register is tried to be changed, the error message "WRITE IS PROHIBITED." is displayed.

\*2 The error message "THE OPERATION IS DISABLED BY ENTRY CODE." is displayed.

\*3 The error message "PLC IS RUNNING." is displayed.

\*3 Available only in the GT Designer2.

2) MELSEC-A Series (including motion controller)

Device name		Setting range		Device number representation	
		GT Designer (2)	DU/WIN		
Bit device	Input (X)	X0~X1FFF	X0~X0FFF	Hexadecimal	
	Output (Y)	Y0~Y1FFF	Y0~Y0FFF		
	Internal relay (M) *1	M0~M8191	M0~M8191	Decimal	
	Latch relay (L) *1	L0~L8191	L0~L8191		
	Annunciator (F)	F0~F2047	F0~F2047		
	Link relay (B)	B0~B1FFF	B0~B1FFF	Hexadecimal	
	Special internal relay (M)	M9000~M9255	M9000~M9255	Decimal	
	Timer (T)	Contact	TT0~TT2047		T0~T2047
		Coil	TC0~TC2047		-
	Counter (C)	Contact	CT0~CT1023		C0~C1023
		Coil	CC0~CC1023		-
	GOT internal bit register (GB) *2		GB132~1023		GB132~1023
Word device	Data register (D)	D0~D8191	D0~D8191		Hexadecimal
	Special data register (D)	D9000~D9255	D9000~D9255		
	Link register (W)	W0~W1FFF	W0~W1FFF		
	Timer (T)	Present value	TN0~TN2047	T0~T2047	Decimal
		Set value *3	TS0~TS2047	T0~T2047	
	Counter (C)	Present value	CN0~CN1023	C0~C1023	
		Set value *3	CS0~CS1023	C0~C1023	
	File register (R) *3		R0~R8191	R0~R8191	
	Accumulator (A) *5		A0~A1	-	
	Index register (Z, V) *4	Z0~Z6(Z0=Z)		Z	
V0~V6(V0=V)		V			
GOT internal data register (GD) *2		GD100~1023	GD100~1023		

\*1 Latch relays (L) are treated as internal relays (M) in the GOT-F900.

\*2 GB132 to GB255 and GD100 to GD127 in the F920GOT-K

\*3 In data changes, the condition shown below is present.

Condition enabling data changes					
While the GOT is connected to the A Series PLC or A Series computer link unit, data cannot be changed in set values (specified directly) of timers and counters and file registers in the following condition.					
PLC status		While PLC is stopped		While PLC is running	
Memory type		RAM	ROM	RAM	ROM
Entry code	Present	✓	x*1	✓	x*1
	Not present	x*2		x*2	
The following error messages are displayed on the screen only when a timer, counter or file register is accessed through a Numeric Input or ASCII input.					
*1 When data of a set value (specified directly) of a timer or counter is tried to be changed, the error message "WRITE IS PROHIBITED." is displayed. (Set values of timers and counters can be changed if they are specified indirectly using data registers.)					
When data of a file register is tried to be changed, the error message "WRITE IS PROHIBITED." is displayed.					
*2 The error message "THE OPERATION IS DISABLED BY ENTRY CODE." is displayed.					

\*4 In computer link connection, index registers (Z, V) cannot be monitored or written.

\*5 In computer link connection, accumulator (A) cannot be monitored or written.

1	Introduction
2	Outline
3	Specifications
4	Installation and Wiring of F940GOT
5	Installation and Wiring of Handy GOT
6	Connection of Peripheral Equipment
7	Connection of Two or More GOT Units
8	Connection of MELSEC-FX Series PLC
9	Connection of MELSEC-A Series PLC
10	Connection of MELSEC-QnA Series PLC

3) MELSEC-QnA/Q (Q mode) Series

Device name		Setting range		Device number representation	
		GT Designer (2)	DU/WIN		
Bit device	Input (X)	X0~X1FFF	X0~X1FFF	Hexadecimal	
	Output (Y)	Y0~Y1FFF	Y0~Y1FFF		
	Internal relay (M)	M0~M32767	M0~M32767	Decimal	
	Latch relay (L)	L0~L32767	L0~L32767		
	Annunciator (F)	F0~F32767	F0~F32767		
	Link relay (B)	B0~B7FFF	B0~B7FFF	Hexadecimal	
	Special link relay (SB)	SB0~SB7FF	SB0~SB7FF		
	Timer (T)	Contact	TT0~TT32767	T0~T32767	Decimal
		Coil	TC0~TC32767	-	
	Counter (C)	Contact	CT0~CT32767	C0~C32767	
		Coil	CC0~CC32767	-	
	Special relay (SM)	SM0~SM2047	SM0~SM2047		
	Retentive timer (ST)	Contact	SS0~SS32767	SS0~SS32767	
		Coil	SC0~SC32767	SC0~SC32767	
Step relay (S)	S0~S32767	S0~S32767			
GOT internal bit register (GB) *1	GB132~GB1023	GB132~GB1023			
Word device	Data register (D)	D0~D32767	D0~D32767	Hexadecimal	
	Special register (SD)	SD0~SD2047	SD0~SD2047		
	Link register (W)	W0~W7FFF	W0~W7FFF		
	Special link register (SW)	SW0~SW7FF	SW0~SW7FF		
	Timer (T)	Present value	TN0~TN32767	T0~T32767	Decimal
		Set value	-	-	
	Counter (C)	Present value	CN0~CN32367	C0~C32367	
		Set value	-	-	
	Retentive timer (present value) (SN)	SN0~SN32767	SN0~SN32767		
	File register (R)	R0~R32767 *2	R0~R32767 *2		
Index register (Z)	Z0~Z15	Z			
GOT internal data register (GD) *1	GD100~GD1023	GD100~GD1023			

\*1 GB132 to GB255 and GD100 to GD127 in the F920GOT-K

\*2 File registers in a block changed over by the RSET instruction are regarded as targets.

**Restriction in set monitor in computer link for A Series**

When a computer link unit for the A Series is attached to the QnA CPU and the GOT-F900 is connected to the unit, the set monitor range is equivalent to that in the AnA CPU, and the restriction shown in the table below is applied (by the restriction in computer link).

Device name		Setting range		Device number representation
		GT Designer (2)	DU/WIN	
Word device	Timer (Present value)	TN0 to TN255	T0 to T255	Decimal
	Timer (Set value)	-	-	
	Counter (Present value)	CN0 to C255	CN0 to C255	
	Counter (Set value)	-	-	
	File register	-	-	

-: Monitor and write disabled

**Specification of PLC number when using Q multiple PLC system**

Specify the PLC number when appointing the device.

- 0: CPU connected (Control PLC if connected to the link)
- 1 to 4: CPU with the specified number

**4) FX Series GM positioning unit (GM direct connection)**

Device name		Setting range		Device number representation
		GT Designer (2)	DU/WIN	
Bit device	Input (X) *1	X0~X377	X0~X377	Octal
	Output (Y)	Y0~Y67	Y0~Y67	
	Internal relay (M)	M0~M511	M0~M511	Decimal
	Special auxiliary relay (SM)	M9000~M9175	M9000~M9175	
	GOT internal bit register (GB)	GB132~1023	GB132~1023	
Word device	Data register (D)	D0~D3999	D0~D3999	Decimal
	Special data register (SD)	D9000~D9313	D9000~D9313	
	File register (R)	D4000~D6999	D4000~D6999	
	Index register (Z, V)	Z0~Z6 (32 bits)	Z (32 bits)	
		V0~V6 (16 bits)	V (16 bits)	
GOT internal data register (GD)	GD100~1023	GD100~1023		

\*1 Devices cannot be written.

1

Introduction

2

Outline

3

Specifications

4

Installation and Wiring of F940GOT

5

Installation and Wiring of Handy GOT

6

Connection of Peripheral Equipment

7

Connection of Two or More GOT Units

8

Connection of MELSEC-F FX Series PLC

9

Connection of MELSEC-A Series PLC

10

Connection of MELSEC-QnA Series PLC

5) FREQROL Series inverter (INV direct connection)

Device name		Setting range		Device number representation
		GT Designer (2)	DU/WIN	
Bit device	Control status (S)	S0:□~S7:□		Decimal
	GOT internal bit register (GB)	GB132~1023		
Word device	Alarm code (A)	A0:□~A7:□		
	Parameter (Pr)	Pr0:□~Pr993:□		
	Program operation (PG)	PG0:□~PG89:□		
	Special parameter (SP)	SP108:□~SP127:□		
GOT internal data register (GD)		GD100~1023		

"□" indicates the station number of the monitored inverter.

Specify the station number using either of the following methods.

- a) Station No. specification (direct) : Specify the station number of the inverter when setting the device.  
[Available setting range: 0 to 31]
- b) Station No. specification (indirect) : Specify the station number of the inverter indirectly using 16-bit GOT internal registers (GD100 to GD115) when setting the device.  
Multiple inverters can be changed on one screen.  
[Available setting range: 100 to 115]  
\* The station No. corresponds to each device of GD100 to GD115.

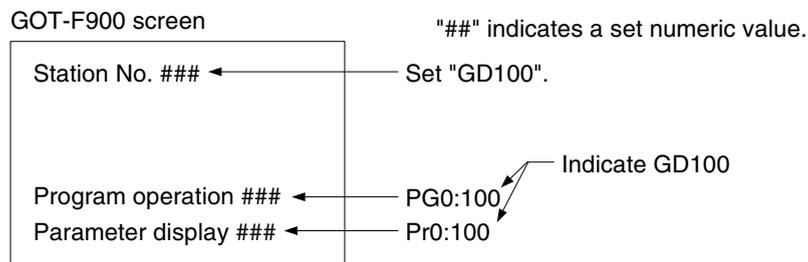

### 3.3.3 PLC Units Manufactured by Other Companies

#### 1) Microcomputer board (general-purpose communication)

Device name		Setting range		Device number representation
		GT Designer (2)	DU/WIN	
Bit device	Bit data (M)	M0~M2047 *1	M0~M2047	Decimal
	Special memory (M) *2	M8000~M8063	M8000~M8063	
	GOT internal bit register (GB) *4	GB132~GB1023	GB132~GB1023	
Word device	Word data (D) *3	D0~D4095	D0~D4095	
	Special memory (M) *2	D8000~D8015	D8000~D8015	
	GOT internal data register (GD) *4	GD100~GD1023	GD100~GD1023	

\*1 The bit data (M) is available in the GT Designer version SW1-E and later.

\*2 The special memory is offered for special application (such as interrupt output and communication error information) in the GOT.

\*3 In the F920GOT-K, D0 to D1023 are available.

\*4 GB132 to GB255 and GD100 to GD127 in the F920GOT-K

#### 2) SYSMAC C Series manufactured by Omron

Device name		Setting range		Device number representation
		GT Designer (2)	DU/WIN	
Bit device	I/O relay	..000000~..614315	00000~51115	Decimal
	Internal auxiliary relay	WR00000~WR51115	—	
	Data link relay (LR)	LR00000~LR19915	L0000~L6315	
	Auxiliary memory relay (AR)	AR00000~AR95915 *1	A0000~A2715	
	Holding relay (HR)	HR00000~HR51115	H0000~H9915	
	Timer contact (TIM)	TIM0~TIM2047	T000~T511	
	Counter contact (CNT)	CNT0~CNT2047	C000~C511	
Word device	GOT internal bit register (GB) *3	GB132~GB1023	GB132~GB1023	Hexadecimal
	Data memory (DM)	DM0~DM9999	D0000~D9999	
	Timer (Present value) (TIM)	TIM0~TIM2047 *2	T000~T511	
	Counter (Present value) (CNT)	CNT0~CNT2047 *2	C000~C511	
	Extension data memory (EM) (current bank)	EM0000~EM9999	—	
	Extension data memory (E0 to EC: 13 banks)	E00000~E09999 : EC0000~EC9999	—	
	GOT internal data register (GD) *3	GD100~GD1023	GD100~GD1023	Decimal

\*1 When the SYSMAC $\alpha$ , CPM1A/2A/2C, CS1 or CS1J Series is connected, auxiliary memory relays (AR) cannot be set to ON or OFF. Do not use AR in the key operation setting (bit).

\*2 Set values cannot be read.

\*3 GB132 to GB255 and GD100 to GD127 in the F920GOT-K

## 3) FLEX-PC N Series manufactured by Fuji Electric

Device name		Setting range		Device number representation
		GT Designer2	DU/WIN	
Bit device	Input (X)	X0~X7FF	X0~X7FF	Hexadecimal
	Output (Y)	Y0~Y7FF	Y0~Y7FF	
	Internal relay (M)	M0~M1FFF	M0~M1FFF	
	Latch relay (L)	L0~L1FFF	L0~L1FFF	
	State (S)	S0~S7FF	S0~S7FF	
	Special internal relay (M)	M8000~M81FF	M8000~M81FF	
	GOT internal bit register (GB)	GB132~GB1023	GB132~GB1023	
Word device	Timer (T)	T0~T3FF	T0~T3FF	
	Counter (C)	C0~C1FF	C0~C1FF	
	Data register (D)	D0~D2FFF	D0~D2FFF	
	Special data register (D)	D8000~D81FF	D8000~D81FF	
	Link register (W)	W0~W3FFF	W0~W3FFF	
	File register (R)	R0~R7FFF	R0~R7FFF	
	GOT internal data register (GD)	GD100~GD1023	GD100~GD1023	

## 4) Machine controller MP900/CP9200SH Series manufactured by Yasukawa Electric

Device name		Setting range		Device number representation
		GT Designer (2)	DU/WIN	
Bit device	Input relay (IB)	IB0~IBFFFF	–	Hexadecimal
	Coil (MB)	MB0~MB4095F	–	*1
	GOT internal bit register (GB)	GB132~GB1023	–	Decimal
Word device	Input register (IW)	IW0~IW7FFF	–	Hexadecimal
	Holding register (MW)	MW0~MW32767	–	Hexadecimal
	GOT internal data register (GD)	GD100~GD1023	–	Decimal

\*1 Word address (decimal) + Bit position (hexadecimal)



## 5) MEWNET-FP Series manufactured by Matsushita Electric Works

Device name		Setting range		Device number representation
		GT Designer (2)	DU/WIN	
Bit device	Input relay (X) <sup>*3</sup>	X0000~X511F	X0000~X511F	Decimal <sup>*6</sup>
	Output relay (Y)	Y0000~Y511F	Y0000~Y511F	
	Internal relay (R) <sup>*4</sup>	R0000~R910F	R0000~R910F	
	Link relay (L) <sup>*1</sup>	L0000~L639F	L0000~L639F	
	Error alarm relay (E) <sup>*2*3</sup>	E0~E2047	E0~E2047	Decimal
	Timer contact (T) <sup>*3</sup>	T0~T3071	T0~T3071	
	Counter contact (C) <sup>*3</sup>	C0~C3071	C0~C3071	
	GOT internal bit register (GB) <sup>*7</sup>	GB132~GB1023	GB132~GB1023	
Word device	Elapsed value of timer/counter (EV)	EV0~EV3071	EV0~EV3071	Decimal
	Set value of timer/counter (SV)	SV0~SV3071	SV0~SV3071	
	Data register (DT) <sup>*4</sup>	DT0~DT16383	DT0~DT16383	
	Link register (LD) <sup>*1</sup>	LD0~LD8447	LD0~LD8447	
	File register (FL) <sup>*1*5</sup>	FL0~FL32764	FL0~FL32764	
	GOT internal data register (GD) <sup>*7</sup>	GD100~GD1023	GD100~GD1023	

Pulse relays (P) and index registers (IX, IY and I) are not available.

\*1 FP0 and FPΣ are excluded.

\*2 Only FP2SH is available.

\*3 Write is disabled.

\*4 Special relays (R9000 to R910F) and special data registers (DT9000 to DT9255) are included also. However, access is disabled in special data registers from D90000 in the FP Series.

\*5 Access is enabled only in the bank 0.

\*6 Bit device number (3-digit decimal number) + Bit position (1-digit hexadecimal number)

\*7 GB132 to GB255 and GD100 to GD127 in the F920GOT-K

1

Introduction

2

Outline

3

Specifications

4

Installation and Wiring of F940GOT

5

Installation and Wiring of Handy GOT

6

Connection of Peripheral Equipment

7

Connection of Two or More GOT Units

8

Connection of MELSEC-FX Series PLC

9

Connection of MELSEC-A Series PLC

10

Connection of MELSEC-QnA Series PLC

## 6) SLC500/MicroLogix Series manufactured by Allen-Bradley

## a) SLC500 Series

## i) GT Designer (earlier than Version 5.05F) and DU/WIN (earlier than Version 2.50)

Device name		Setting range		Device number representation
		GT Designer	DU/WIN	
Bit device	Bit (B)	B0030000~B003255F B0100000~B255255F	B0030000~B003255F B0100000~B255255F	Hexadecimal
	Timer (T) (timing bit)	TT0040000~TT0042550 TT0100000~TT2552550	—	Decimal
	Timer (T) (completion bit)	TN0040000~TN0042550 TN0100000~TN2552550	T0040000~T0042550 T0100000~T2552550	
	Counter (C) (up counter)	CU0050000~CU0052550 CU0100000~CU2552550	—	
	Counter (C) (down counter)	CD0050000~CD0052550 CD0100000~CD2552550	—	
	Counter (C) (completion bit)	CN0050000~CN0052550 CN0100000~CN2552550	C0050000~C0052550 C0100000~C2552550	
	GOT internal bit register (GB)	GB132~GB1023	—	
Word device	Timer (T) *1 (set value)	TP004000~TP004255 TP010000~TP255255	T004000~T004255 T010000~T255255	Decimal
	Timer (T) *1 (current value)	TA004000~TA004255 TA010000~TA255255		
	Counter (T) (set value)	CP005000~CP005255 CP010000~CP255255	C004000~C005255 C010000~C255255	
	Counter (T) (current value)	CA005000~CA005255 CA010000~CA255255		
	Integer (N)	NO07000~N007255 NO10000~N255255	NO07000~N007255 NO10000~N255255	
	GOT internal data register (GD)	GD100~GD1023	—	

\*1 32 bits cannot be specified.

- ii) GT Designer 2 (Version 1.02C or later),  
GT Designer (Version 5.05F or later) and DU/WIN (Version 2.50 or later)

Device name		Setting range		Device number representation
		GT Designer (2)	DU/WIN	
Bit device	Bit (B)	B3:0/0~B3:255/15 B10:0/0~B255:255/15	B3:0/0~B3:255/15 B10:0/0~B255:255/15	Hexadecimal
	Timer (T) (timing bit)	T4:0/TT~T4:255/TT T10:0/TT~T255:255/TT	T4:0/TT~T4:255/TT T10:0/TT~T255:255/TT	Decimal
	Timer (T) (completion bit)	T4:0/DN~T4:255/DN T10:0/DN~T255:255/DN	T4:0/DN~T4:255/DN T10:0/DN~T255:255/DN	
	Counter (C) (up counter)	C5:0/CU~C5:255/CU C10:0/CU~C255:255/CU	C5:0/CU~C5:255/CU C10:0/CU~C255:255/CU	
	Counter (C) (down counter)	C5:0/CD~C5:255/CD C10:0/CD~C255:255/CD	C5:0/CD~C5:255/CD C10:0/CD~C255:255/CD	
	Counter (C) (completion bit)	C5:0/DN~C5:255/DN C10:0/DN~C255:255/DN	C5:0/DN~C5:255/DN C10:0/DN~C255:255/DN	
	GOT internal bit register (GB) *2	GB132~GB1023	GB132~GB1023	
Word device	Timer (T) *1 (set value)	T4:0.PRE~T4:255.PRE T10:0.PRE~T255:255.PRE	T4:0.PRE~T4:255.PRE T10:0.PRE~T255:255.PRE	Decimal
	Timer (T) *1 (current value)	T4:0.ACC~T4:255.ACC T10:0.ACC~T255:255.ACC	T4:0.ACC~T4:255.ACC T10:0.ACC~T255:255.ACC	
	Counter (T) *1 (set value)	C5:0.PRE~C5:255.PRE C10:0.PRE~C255:255.PRE	C5:0.PRE~C5:255.PRE C10:0.PRE~C255:255.PRE	
	Counter (T) *1 (current value)	C5:0.ACC~C5:255.ACC C10:0.ACC~C255:255.ACC	C5:0.ACC~C5:255.ACC C10:0.ACC~C255:255.ACC	
	Integer (N)	N7:0~N7:255 N10:0~N255:255	N7:0~N7:255 N10:0~N255:255	
	GOT internal data register (GD) *2	GD100~GD1023	GD100~GD1023	

\*1 32 bits cannot be specified.

\*2 GB132 to GB255 and GD100 to GD127 in the F920GOT-K

### File number and element specification range

Specify the file number and an element in decimal numbers. However, specify the bit position of a bit (B) in a hexadecimal number.

Device name (symbol)		File number*1	Available element specification range
Bit device	Bit (B)	3 10~255	0~255 *2
	Timer (time counting bit) (TT)	4 10~255	0~255
	Timer (completion bit) (TN)	4 10~255	0~255
	Counter (effective up-count bit) (CU)	5 10~255	0~255
	Counter (effective down-count bit) (CD)	5 10~255	0~255
	Counter (completion bit) (CN)	5 10~255	0~255
Word device	Timer (set value) (TP)	4 10~255	0~255
	Timer (present value) (TA)	4 10~255	0~255
	Counter (set value) (CP)	5 10~255	0~255
	Counter (present value) (CA)	5 10~255	0~255
	Integer (N) (N)	7 10~255	0~255

\*1 File numbers 10 to 255 are available in the user setting.

\*2 For each element, the bit position can be specified in the range from 0 to F (15).

## b) MicroLogix 1000/1200/1500 Series

- i) GT Designer 2 (Version 1.02C or later),  
GT Designer (Version 5.05F or later) and DU/WIN (Version 2.50 or later)

Device name		Setting range		Device number representation
		GT Designer (2)	DU/WIN	
Bit device	Bit (B)	B3:0/0~B255:255/15	B3:0/0~B255:255/15	Hexadecimal
	Timer (T) (timing bit)	T3:0/TT~T255:255/TT	T3:0/TT~T255:255/TT	Decimal
	Timer (T) (completion bit)	T3:0/DN~T255:255/DN	T3:0/DN~T255:255/DN	
	Counter (C) (up counter)	C3:0/CU~C255:255/CU	C3:0/CU~C255:255/CU	
	Counter (C) (down counter)	C3:0/CD~C255:255/CD	C3:0/CD~C255:255/CD	
	Counter (C) (completion bit)	C3:0/DN~C255:255/DN	C3:0/DN~C255:255/DN	
	GOT internal bit register (GB) *2	GB132~GB1023	GB132~GB1023	
Word device	Timer (T) *1 (set value)	T3:0.PRE~T255:255.PRE	T3:0.PRE~T255:255.PRE	Decimal
	Timer (T) *1 (current value)	T3:0.ACC~T255:255.ACC	T3:0.ACC~T255:255.ACC	
	Counter (T) *1 (set value)	C3:0.PRE~C255:255.PRE	C3:0.PRE~C255:255.PRE	
	Counter (T) *1 (current value)	C3:0.ACC~C255:255.ACC	C3:0.ACC~C255:255.ACC	
	Integer (N)	N3:0~N255:255	N3:0~N255:255	
	GOT internal data register (GD) *2	GD100~GD1023	GD100~GD1023	

\*1 32 bits cannot be specified.

\*2 GB132 to GB255 and GD100 to GD127 in the F920GOT-K

**File number and element specification range**

Specify the file number and an element in decimal numbers. However, specify the bit position of a bit (B) in a hexadecimal number.

Device name (symbol)		File number *1	Available element specification range
Bit device	Bit (B)	3~255	0~255 *2
	Timer (timing bit) (T)	3~255	0~255
	Timer (completion bit) (T)	3~255	0~255
	Counter (up counter) (C)	3~255	0~255
	Counter (down counter) (C)	3~255	0~255
	Counter (completion bit) (C)	3~255	0~255
Word device	Timer (set value) (T)	3~255	0~255
	Timer (current value) (T)	3~255	0~255
	Counter (set value) (C)	3~255	0~255
	Counter (current value) (C)	3~255	0~255
	Integer (N) (N)	3~255	0~255

\*1 File numbers 3 to 255 are available in the user setting.

\*2 For each element, the bit position can be specified in the range from 0 to 15.

7) S7-200/300/400 Series manufactured by Siemens

a) S7-200 Series

Device name		Setting range		Device number representation
		GT Designer (2)	FX-PCS-DU/WIN	
Bit device	Variable Memory (V)	V00~V51197	V0.0~V5119.7	Decimal
	Input (I)	I00~I77	I0.0~I7.7	
	Output (Q)	Q00~Q77	Q0.0~Q7.7	
	Bit memory (M)	M00~M317	M0.0~M31.7	
	Special Memory (SM)	SM00~SM1947	SM0.0~SM194.7	
	Timer (T) *1	T0~T255	T0~T255	
	Counter (C) *1	C0~C255	C0~C255	
	Sequence Control Relay (S)	S00~S317	S0.0~S31.7	
	GOT internal bit register (GB)	GB132~GB1023	GB132~GB1023	
Word device	Variable Memory (V) *6	VW0~VW5118	VW0~VW5118	
	Input (I) *6	IW0~IW6	IW0~IW6	
	Output (Q) *6	QW0~QW6	QW0~QW6	
	Analog Input (AI) *2*6	AIW0~AIW30	AIW0~AIW30	
	Analog Output (AQ) *6	AQW0~AQW30	AQW0~AQW30	
	Bit memory (M) *6	MW0~MW30	MW0~MW30	
	Special Memory (SM) *3*6	SMW0~SMW192	SMW0~SMW192	
	Timer (T) (16bit) *4	T0~T255	T0~T255	
	Counter (C) (16bit) *4	C0~C255	C0~C255	
	High Speed Counter (HC) (32bit) *5	HC0~HC2	HC0~HC2	
	Sequence Control Relay (S) *6	SW0~SW30	SW0~SW30	
	GOT internal data register (GD)	GD100~GD1023	GD100~GD1023	

\*1 Bit devices T and C cannot be written.

\*2 Word devices HC and AI cannot be written.

\*3 Word device SM cannot be monitored.

\*4 Word devices T and C are the 16-bit type.

\*5 Word device HC is the 32-bit type.

\*6 Only even byte addresses are available.

**Note on number representation**

A decimal point exists when using the GT Designer (2) but not when using the DU/WIN.

Bit device	Device name V,I,Q,M,SM,T,C,S	Byte address	Bit address 0 to 7
Word device	Device name VW,IW,QW,AI,AQ,M,SM,T,C,HC,S	Device number	

- 1 Introduction
- 2 Outline
- 3 Specifications
- 4 Installation and Wiring of F940GOT
- 5 Installation and Wiring of Handy GOT
- 6 Connection of Peripheral Equipment
- 7 Connection of Two or More GOT Units
- 8 Connection of MELSEC-FX Series PLC
- 9 Connection of MELSEC-A Series PLC
- 10 Connection of MELSEC-QnA Series PLC

## b) S7-300, S7-400 Series

Device name		Setting range		Device number representation
		GT Designer (2)	DU/WIN	
Bit device	Input relay (I)	I0~I5117	I0.0~I511.7	Decimal
	Output relay (Q)	Q0~Q5117	Q0.0~Q511.7	
	Bit memory (M)	M0~M20477	M0.0~M2047.7	
	GOT internal bit register (GB) *1	GB132~GB1023	GB132~GB1023	
Word device	Present value of timer (T)	T0~T511	T0~T511	
	Present value of counter (C)	C0~C511	C0~C511	
	Data register (D)	D000100000~D102365534	DB□.DBW0~DB□.DBW65534	
	GOT internal data register (GD) *1	GD100~GD1023	GD100~GD1023	

"□" indicates a number in the range from 1 to 1023.

Only even values are available as byte addresses of data register (DBW values).

\*1 GB132 to GB255 and GD100 to GD127 in the F920GOT-K

**Note on number representation**

A decimal point exists when using the GT Designer (2) but not when using the DU/WIN.

Bit device	Device name I,Q,M	Byte address 0 to 511,2047	·	Bit address 0 to 7
Word device	Device name T,C	Device number 000 to 511		
	Device name DB	Block number 1 to 1023	·	Byte address DBW0 to DBW65534

# MEMO

1	Introduction
2	Outline
3	Specifications
4	Installation and Wiring of F940GOT
5	Installation and Wiring of Handy GOT
6	Connection of Peripheral Equipment
7	Connection of Two or More GOT Units
8	Connection of MELSEC-F FX Series PLC
9	Connection of MELSEC-A Series PLC
10	Connection of MELSEC-QnA Series PLC

### 3.4 Hardware Specifications

This section explains the hardware specifications of the GOT-F900 Series.

#### 1) General specifications

"□" of the GOT model name indicates 0 or 3.

Item	F940WGOT	F940GOT		F930GOT-K
Product model name	F940WGOT-TWD-E	F940GOT-SWD-E	F940GOT-LWD-E	F930GOT-BBD-K-E
<b>Power supply specifications</b>				
Supply voltage	24V DC+10%-15% (service power supply of PLC or separately prepared DC power supply)			
24V DC current consumption (backlight OFF)	650mA/24V DC*1 (400mA/24V DC)	410mA/24V DC	390mA/24V DC	220mA/24V DC (120mA/24V DC)
Fuse	Built-in (irreplaceable)			
Allowable momentary power failure time	Operation continues against power failure of 5ms or less.			
Built-in lithium battery	PM-20BL (life: Approx. 5 years)	PM-20BL (life: Approx. 5 years)		FX2NC-32BL (life: Approx. 3 years)
<b>Environmental specifications</b>				
Ambient temperature	0~50×C*2	0~50×C*3		0~50×C
Ambient humidity	35 to 85%RH (no condensation)			
Working atmosphere	Must be free of lamp black, corrosive gas, flammable gas, or excessive amount of electroconductive dust particles and must be no direct sunlight. (Same as for saving)			
Vibration resistance		Frequency	Acceleration	Amplitude
	With intermittent vibration	10~57Hz	–	0.075mm
		57~150Hz	9.8m/s <sup>2</sup>	–
	With continuous vibration	10~57Hz	–	0.035mm
57~150Hz		4.9m/s <sup>2</sup>	–	
	10 times in each of X, Y and Z directions (for 80 min)			
Impact resistance	147 m/s <sup>2</sup> , 3 times in each of X, Y and Z directions			
Noise resistance	By noise simulator of 1,000 Vp-p in noise voltage, 1 μs in noise width and 30 to 100 Hz in frequency			
Withstand voltage	500V AC for 1 min (between all power terminals and ground terminal)			
Insulation resistance	5 MΩ or more by 500V DC megger (between all power terminals and ground terminal)			
Grounding	Grounding resistance 100Ω or less			
Protective structure	Equivalent to IP65f *5*6	Equivalent to IP65f *5*6		Equivalent to IP65f *5*6



	F930GOT	F920GOT-K		Handy GOT																				
	F930GOT-BWD-E	F920GOT-BBD-K-E	F920GOT-BBD5-K-E	F940GOT-SBD-(R)H-E	F940GOT-LBD-(R)H-E																			
			5V DC Supplied from PLC	24V DC+10%-15% (separately prepared DC power supply)																				
	200mA/24V DC	80mA/24V DC (70mA/24V DC)	220mA/5V DC (180mA/5V DC)	300mA/24V DC (200mA/24V DC)																				
	Built-in (irreplaceable)		–	Built-in (irreplaceable)																				
	Operation continues against power failure of 5ms or less.		–	Operation continues against power failure of 5ms or less.																				
	FX2NC-32BL (life: Approx. 3 years)	–		FX2NC-32BL (life: Approx. 3 years)																				
	0~50°C	0~50°C		0~40°C																				
	35 to 85%RH (no condensation)																							
	Must be free of lamp black, corrosive gas, flammable gas, or excessive amount of electroconductive dust particles and must be no direct sunlight. (Same as for saving)																							
	<table border="1"> <thead> <tr> <th></th> <th>Frequency</th> <th>Acceleration</th> <th>Amplitude</th> <th rowspan="6">10 times in each of X, Y and Z directions (for 80 min)</th> </tr> </thead> <tbody> <tr> <td rowspan="2">With intermittent vibration</td> <td>10~57Hz</td> <td>–</td> <td>0.075mm</td> </tr> <tr> <td>57~150Hz</td> <td>9.8m/s<sup>2</sup></td> <td>–</td> </tr> <tr> <td rowspan="2">With continuous vibration</td> <td>10~57Hz</td> <td>–</td> <td>0.035mm</td> </tr> <tr> <td>57~150Hz</td> <td>4.9m/s<sup>2</sup></td> <td>–</td> </tr> </tbody> </table>						Frequency	Acceleration	Amplitude	10 times in each of X, Y and Z directions (for 80 min)	With intermittent vibration	10~57Hz	–	0.075mm	57~150Hz	9.8m/s <sup>2</sup>	–	With continuous vibration	10~57Hz	–	0.035mm	57~150Hz	4.9m/s <sup>2</sup>	–
	Frequency	Acceleration	Amplitude	10 times in each of X, Y and Z directions (for 80 min)																				
With intermittent vibration	10~57Hz	–	0.075mm																					
	57~150Hz	9.8m/s <sup>2</sup>	–																					
With continuous vibration	10~57Hz	–	0.035mm																					
	57~150Hz	4.9m/s <sup>2</sup>	–																					
	147 m/s <sup>2</sup> , 3 times in each of X, Y and Z directions																							
	By noise simulator of 1,000 Vp-p in noise voltage, 1 μs in noise width and 30 to 100 Hz in frequency																							
	←	500V AC for 1 min *4		500V AC for 1 min (between all power terminals and ground terminal)																				
	←	5 MΩ or more by 500V DC megger *4		5 MΩ or more by 500V DC megger (between all power terminals and ground terminal)																				
	←	Grounding resistance 100Ω or less	–	Grounding resistance 100Ω or less																				
	Equivalent to IP65f *5*6	Equivalent to IP65f *5*6		Equivalent to IP54 *5*6																				

\*1 When the power is turned on, the current consumption of 750 mA/24V DC maximum is applied.

\*2 0 to 50°C when the screen is installed laterally. 0 to 40°C when the screen is installed longitudinally or horizontally.

\*3 0 to 40°C when the extension interface is used.

\*4 F920GOT-BBD-K is between all power terminals and ground terminal, and F920GOT-BBD5-K is between all power terminals of the PLC and ground terminal.

\*5 The relevancy is confirmed in the test for IP65f or IP54. However, this test result does not provide any guarantees that the product stands against use in all sorts of environment.

\*6 As regarding the front panel

## 2) Switch/lamp/buzzer specifications

"□" of the GOT model name indicates 0 or 3.

Item	F940WGOT	F940GOT	F930GOT-K	F930GOT	
Product model name	F940WGOT-SWD-E	F940GOT-SWD-E F940GOT-LWD-E	F930GOT-BBD-K-E	F930GOT-BWD-E	
<b>Switch/Key</b>					
Operation switch	–	–	–	–	
Function key	–	–	8 switches	–	
Grip switch	–	–	–	–	
Emergency stop switch	–	–	–	–	
Keylock switch	–	–	–	–	
Ten-key keypad	–	–	0~9, (-), (.)	–	
Cursor key	–	–	ENT,ESC,SET,DEV, ▼,◀,▶,▲	–	
<b>Lamp</b>					
Power indicator LED	–	1 LED (green)	–	–	
Operation indicator LED	–	–	–	–	
Function key LED	–	–	8 switches(green)	–	
Grip switch indicator LED	–	–	–	–	
<b>Buzzer</b>					
Buzzer <sup>*1</sup>	–	–	–	–	
Built-in buzzer <sup>*2</sup>	Provided	Provided	Provided	Provided	

F920GOT-K		Handy GOT			
F920GOT-BBD-K-E F920GOT-BBD5-K-E		F94□GOT-SBD-H-E F94□GOT-LBD-H-E		F94□GOT-SBD-RH-E F94□GOT-LBD-RH-E	
	-	4 switches (4 contacts/common)	a contact 10 mV/24V DC Life: 1,000,000 times	4 switches (4 contacts/common)	a contact 10 mV/24V DC Life: 1,000,000 times
	6 switches	-	-	-	-
	-	1 switch (assigned as key in display unit)	-	1 switch (JSHD4H2 manufactured in Sweden) 3-positioned OFF/ON/OFF (individual wiring)	2a contact 1A/24V DC (resistance load)
	-	1 switch (AH165-VR01 manufactured by Fuji Electric) (individual wiring)	b contact 1A/24V DC (resistance load) Life: 100,000 times or more	1 switch (AH165-VR02 manufactured by Fuji Electric) (individual wiring)	2b contact 1A/24V DC (resistance load) Life: 100,000 times or more
	-	-	-	1 switch (with 2 keys) (AS6M-2KT1PB manufactured by IDEC Corporation) (individual wiring)	c contact 1A/24V DC (resistance load) Life: 100,000 times or more
	0~9, (-), (.)	-	-	-	-
	ENT,ESC,SET,DEV, ▼,◀,▶,▲	-	-	-	-
	-	1 LED (green)	-	1 LED (green)	-
	-	4 LED (green)	-	4 LED (green)	-
	-	-	-	-	-
	-	1 LED (green)	-	1 LED (green)	-
	-	-	-	-	-
	Provided	Provided	Provided	Provided	Provided

\*1 The buzzer sounds as its power input from the outside of the GOT.

\*2 The built-in buzzer sounds when a touch key on the screen (except F920GOT-K) is pressed.  
The built-in buzzer sounds when a key-pad (F920GOT-K and F930GOT-K only) is operated.

1	Introduction
2	Outline
3	Specifications
4	Installation and Wiring of F940GOT
5	Installation and Wiring of Handy GOT
6	Connection of Peripheral Equipment
7	Connection of Two or More GOT Units
8	Connection of MELSEC-F FX Series PLC
9	Connection of MELSEC-A Series PLC
10	Connection of MELSEC-QnA Series PLC

## 3) External interface specifications

"□" of the GOT model name indicates 0 or 3.

Item	F940WGOT	F940GOT	F930GOT(-K)	
Product model name	F940WGOT-SWD-E	F940GOT-SWD-E F940GOT-LWD-E	F930GOT-BWD-E F930GOT-BBD-K-E	
<b>Serial interface</b>				
RS-232C	9-pin D-Sub, male port, 2 channels #4-40UNC Inch screw thread	9-pin D-Sub, male port #4-40UNC Inch screw thread	9-pin D-Sub, male port #4-40UNC Inch screw thread	
RS-422	9-pin D-Sub, female port M2.6 Metric screw thread	9-pin D-Sub, female port M2.6 Metric screw thread	9-pin D-Sub, female port M2.6 Metric screw thread	
<b>Extended I/O connection</b>				
For operation switch	–	–	–	
For emergency stop switch	–	–	–	

F920GOT-K		Handy GOT			
F920GOT-BBD-K-E F920GOT-BBD5-K-E		F94□GOT-SBD-H-E F94□GOT-LBD-H-E		F94□GOT-SBD-RH-E F94□GOT-LBD-RH-E	
9-pin D-Sub, male port #4-40UNC Inch screw thread		9-pin D-Sub, male connector Screen data transfer Dedicated to personal computer port		9-pin D-Sub, male connector Screen data transfer Dedicated to personal computer port	
9-pin D-Sub, female port M2.6 Metric screw thread		Dedicated port F940GOT-*BD-H:RS-422 F943GOT-*BD-H:RS-232C		Dedicated port F940GOT-*BD-RH:RS-422 F943GOT-*BD-RH:RS-232C	
-		4 switches (4 contacts/common)		4 switches (4 contacts/common)	
-		1 switch(a contact)		1 switch(a contact)	
		External cable (with 25-pin D-Sub connector or untied)		External cable (with 37-pin D-Sub connector)	

1	Introduction
2	Outline
3	Specifications
4	Installation and Wiring of F940GOT
5	Installation and Wiring of Handy GOT
6	Connection of Peripheral Equipment
7	Connection of Two or More GOT Units
8	Connection of MELSEC-F FX Series PLC
9	Connection of MELSEC-A Series PLC
10	Connection of MELSEC-QnA Series PLC

### 3.5 Display specifications

Display language (system language/user screen language) in the table below covers only Japanese models. For world spec models, refer to "In-built Fonts of Graphic Operation Terminal (Japanese/Overseas product)" in Introduction.

Item	F920GOT-K	F930GOT	F930GOT-K
Product model name	F920GOT-BBD5-K-E, F920GOT-BBD-K-E	F930GOT-BWD-E	F930GOT-BBD-K-E
<b>Display element</b>			
LCD type	STN type full dot matrix LCD	STN type full dot matrix LCD	
Dot pitch H×V (mm)	0.47×0.47	0.47×0.47	
Display color	2-color monochrome (blue/white)	2-color monochrome (blue/white)	
Viewing angle	–	Right and left 30°, Top 20°, Bottom 30°	
Screen (For details, refer to the following.)	128×64 dots LCD 8 characters × 4 lines (2-byte characters) Effective display dimensions: 60×30mm (type 3)	240×80 dots LCD 15 characters × 5 lines (2-byte characters) Effective display dimensions: 117×42mm (type 4)	
Life	LCD Approx. 50,000hours (working temperature: 25°C, normal humidity)	LCD Approx. 50,000hours (working temperature: 25°C, normal humidity)	
<b>Display language</b>			
System language	Japanese, English (Japanese can be selected as a system language only when it is being selected as a user display language.)		
User display language	Japanese (JIS Chinese character codes first and second standard), English, Italian, Dutch, Swedish, Spanish, Danish, German, Portuguese, French	Japanese (JIS Chinese character codes first and second standard <sup>2</sup> ), English, Italian, Dutch, Swedish, Spanish, Danish, German, Portuguese, French	
	Alphabet, numeric, and kana can be displayed from half to 8 times larger in height and from 1 to 8 times larger in width, and Chinese characters from 1 to 8 times larger in height and width.		
Drawing environment (Windows)	<b>For Windows 2000, Windows XP</b> Multi-language input function supports multiple languages. Both Japanese and English versions of Designer2 can be used.  <b>For other version of Windows</b> <b>To display in Japanese</b> Start GT Designer2 on a Japanese OS (Windows) and draw pictures. <b>To display in other languages than Japanese</b> Start GT Designer2 (SW1D5C-GTD2-E) English version on the OS (Windows) supporting each language to draw pictures.		
<b>Backlight</b>			
Type	LED (Selectable between red and white)	Cold-cathode tube	
Life	–	Approx. 50,000hours or more (working temperature: 25°C)	
<b>Touch switches</b>			
Number of used piece	No touch switch	Max. 50 touch switches/screen	
Configuration (H×V)	–	15×4 matrix configuration	
<b>Number of screens</b>			
Base screen	Max. 500 user drawing screens Screen No. is from No.1 to No.500 when GT Designer2 is used. (Screen No. is from No.0 to No.499 when data created by FX-PCS-DU/WIN is used.)		
Key window screen	–	3 screens (Screen No.: No.1 to 3)	
System screen	12 screens (Screen No.: No.1001 to 1030)	25 screens (Screen No.: No.1001 to 1030)	
<b>Memory</b>			
User memory	Flash memory 128KB	Flash memory 256KB	

F940GOT, F940 Handy GOT		F940WGOT
F940GOT-LWD-E, F940GOT-LBD-H-E, F943GOT-LBD-H-E	F940GOT-SWD-E, F940GOT-SBD-H-E, F943GOT-SBD-H-E	F940WGOT-TWD-E
STN type full dot matrix LCD		TFT type full dot matrix LCD
0.36×0.36		0.324×0.375
2-color monochrome (black/white)	8 colors	256 colors
Right and left 30°, Top and Bottom 30°	Right and left 50°, Top 45°, Bottom 60°	—
320×240 dots LCD 20 characters × 15 lines (2-byte characters) Effective display dimensions: 115×86mm (type 6)		480×234 dots LCD 30 characters × 14 lines (2-byte characters) Effective display dimensions: 155.5×87.8mm (type 7)
LCD Approx. 50,000hours (working temperature: 25°C, normal humidity)		
Japanese, English (Japanese can be selected as a system language only when it is being selected as a user display language.)		
Japanese (JIS Chinese character codes first standard), English, Chinese (simplified characters), Chinese (traditional characters), Korean, Italian, Dutch, Swedish, Spanish, Danish, German, Portuguese, French		Japanese (JIS Chinese character codes first and second standard), English, Chinese(simplified characters), Chinese(traditional characters), Korean, Italian, Dutch, Swedish, Spanish, Danish, German, Portuguese, French
Alphabet, numeric, and kana can be displayed from half to 8 times larger in height and from 1 to 8 times larger in width, and Chinese characters from 1 to 8 times larger in height and width.		
<b>For Windows 2000, Windows XP</b> Multilingual input function of Windows enables inputting each language. Both Japanese and English versions of Designer2 can be used.		
<b>For other version of Windows</b> <b>To display in Japanese</b> Start GT Designer2 on a Japanese OS (Windows) and draw pictures. <b>To display in other languages than Japanese</b> Start GT Designer2 (SW1D5C-GTD2-E) English version on the OS (Windows) supporting each language to draw pictures.		
Cold-cathode tube		
Approx. 40,000hours or more (working temperature:25°C)		
Max. 50 touch switches/screen		
20×12 matrix configuration		30×12 matrix configuration
Max. 500 user drawing screens Screen No. is from No.1 to No.500 when using GT Designer2) (Screen No. is from No.0 to No.499 when using data created by FX-PCS-DU/WIN)		
3 screens (Screen No.: No.1 to No.3)		
30 screens (Screen No.: No.1001 to No.1030)		
Flash memory 512KB		Flash memory 1MB

\*1 F940WGOT is displayed vertically long since the dot pitch H×V (mm) is approx. 1 to 1.16.

\*2 For F930GOT and F930GOT-K, JIS Chinese character code second standard has been added after SERIAL 31\*\*\*\* (produced in Jan., 2003).

- Bright dots (always lit) and dark dots (unlit) may appear on a liquid crystal display panel. It is impossible to completely avoid this symptom, as the liquid crystal display comprises of a great number of display elements. Flickers may be observed depending on the display color.  
Please note that these dots appear due to its characteristic and are not caused by product defect.
- When the same screen is displayed for a long time, an incidental color or partial discoloration is generated on the screen due to heat damage, and it may not disappear.
- Using the GOT Backlight OFF function can prolong the life of the backlight.  
For details on the Backlight OFF function, refer to the following.  
GOT-F900 Series OPERATION MANUAL/GOT-F900 Series OPERATION MANUAL  
[GT Designer2 Version]



## 4. Installation and Wiring of F920GOT-K/F930GOT(-K)/F940(W)GOT



### Cautions on installation

- Use the F920GOT-K/F930GOT(-K)/F940(W)GOT in the environment for the general specifications described in this manual.  
Never use the F920GOT-K/F930GOT(-K)/F940(W)GOT in a place with dusts, soot, conductive dusts, corrosive gas or flammable gas, place exposed to high temperature, condensation or wind and direct sunlight, rain, or place subject to vibrations and impacts.  
If the F920GOT-K/F930GOT(-K)/F940(W)GOT is used in an unfavorable place described above, electrical shock, fire or malfunction, damages or deterioration of the F930GOT/F940(W)GOT may be caused.
- Never drop cutting chips and electric wire chips into the ventilation window of the F920GOT-K/F930GOT(-K)/F940(W)GOT when you drill screw holes or perform the wiring work.  
Otherwise, fire, failure or malfunction may be caused.
- Connect connection cables securely to the specified connectors while the power is turned OFF.  
Imperfect connection may cause malfunction or failure.



### Caution on wiring

- Make sure to shut down all phases of the power supply outside the F920GOT-K/F930GOT(-K)/F940(W)GOT before starting the installation or wiring work.  
Otherwise, electrical shock and damages of the F930GOT/F940(W)GOT may be caused.



### Caution

- The F920GOT-K/F930GOT(-K)/F940(W)GOT has the DC power specifications. Connect the DC power cable to dedicated terminals as described in this manual.  
If the AC power supply is connected to power terminals, the F930GOT/F940(W)GOT may be burnt.
- Mount and connect a fuse of 2 A to the 24V DC power supply. Connect the + and - sides of the DC power supply correctly as described in this manual.  
If the power supply is connected reversely, failure may be caused.
- Perform Class D grounding to the ground terminal ( $\perp$ ) of the F930GOT/F930GOT-K/F940(W)GOT using a wire of 1.25 mm<sup>2</sup> or more.  
When supplying the power from the PLC (excluding the F940WGOT), connect the F930GOT/F930GOT-K/F940(W)GOT to the ground terminal of the PLC. When supplying the power from the outside, connect the F930GOT/F940(W)GOT to the ground terminal of the external power supply.  
However, never perform common grounding with the strong electrical system.



### Caution on design

- While executing monitoring in the GOT (GOT-F900), if a communication error (including disconnection of a cable) occurs, communication between the GOT and the PLC CPU is interrupted and the GOT is disabled.  
When establishing the system configuration using the GOT, make sure that a switch which gives a significant operation to the system is executed from any equipment other than the GOT while postulating communication error in the GOT. Otherwise, accidents may be caused by incorrect output and malfunction.



### Caution

- Do not bind the control cable and the communication cable together with the main circuit and the power line. Keep such cables off the main circuit and the power line by 100 mm or more.  
Otherwise, malfunction may be caused by noise.
- Make sure to press touch keys on the display screen with hand. If touch keys are subject to an excessive force or pressed by a hard or sharp object, they may fail.

**Note**

- Even if momentary power failure of less than 5 ms occurs in the power supply, the F930GOT/F930GOT-K/F940(W)GOT continues the operation.  
If long-time power failure or voltage drop occurs, the F930GOT/F940(W)GOT stops the operation. When the power supply is recovered, the F930GOT/F940(W)GOT restarts the operation.
- Use electric wires of 0.75 mm<sup>2</sup> or more in wiring of the power supply so that voltage drop does not occur. Use solderless terminals for M3, and tighten them securely with the tightening torque of 0.5 to 0.8 N•m so that troubles are not caused.

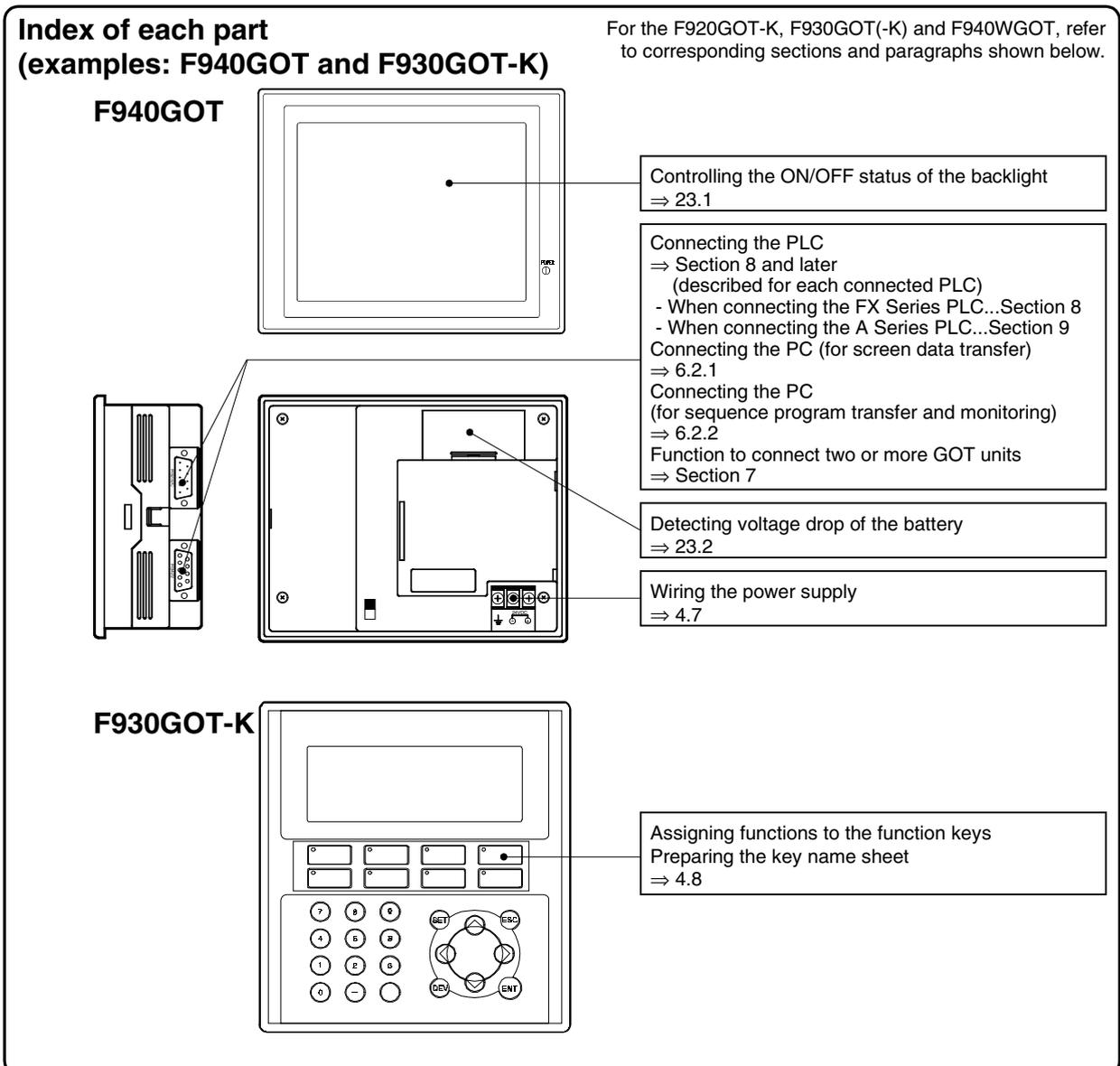

This section explains installation on the panel face and wiring of the power supply, etc.

### Wiring and setting procedures

This section introduces the procedure to connect the GOT-F900 to connected equipment such as PLC.

#### 1. Preparation

Item name	Description	Reference
Outline of Connection	You can learn the outline of the connection method.	4.1
Name of each Part	You can learn the name of each part of the F930GOT/F940(W)GOT.	4.2
Processing of Panel Face	You can learn the dimension of the processing on the panel face.	4.3
Installation	You can learn the method to install the F920GOT-K/F930GOT/F930GOT-K/F940(W)GOT.	4.4
Connector Pin Layout and Signal Name	You can check the connector signal names.	4.5

#### 2. Wiring

Item name	Description	Reference
Outline of Internal Wiring	You can check block diagrams of portions requiring wiring and the internal wiring.	4.6
Wiring for 24V DC and 5V DC Power Supply and Class D Grounding	You can check the methods to wire the 24 VDC power supply and perform Class D grounding.	4.7
Handling of function keys	You can learn how to use the function keys. (Setting in the screen creation software is required.)	4.8

#### 3. Setting

Item name	Description	Reference
Setting of Connected Equipment for GOT	You can learn the method to make the functions and LEDs of the function keys available using the screen creation software.	4.9

### 4.1 Outline of Connection

This section explains the outline of the cables connecting the GOT-F900 to the PLC.

#### Panel installation

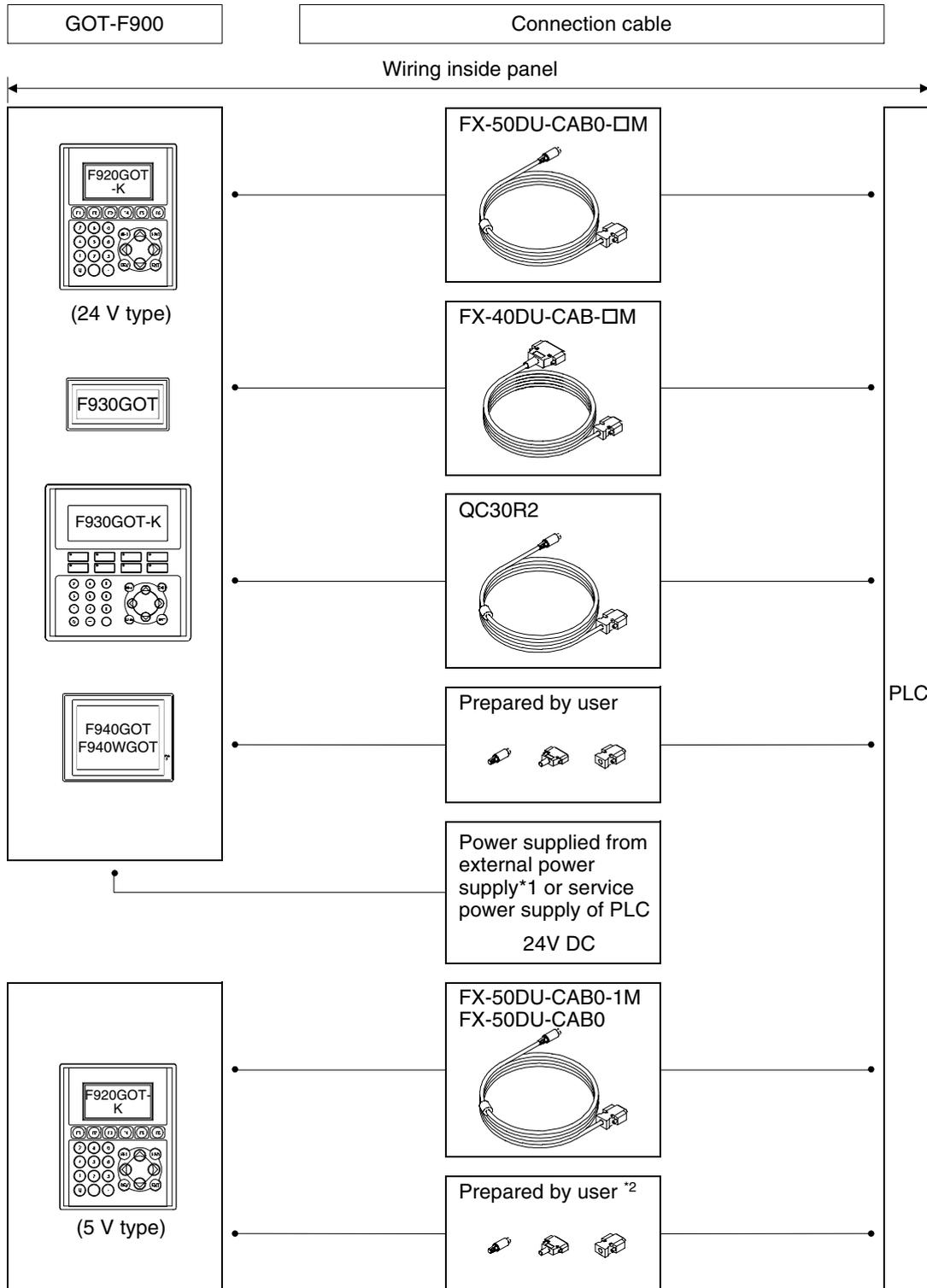

\*1 Because the F940WGOT consumes much current, it cannot be connected to the service power supply of the PLC. Prepare an external power supply.

\*2 The cable to connect the 5V type F920GOT-K to the FX, FX2c, A, QnA and Q Series PLC needs to be prepared by the user. The 5V DC power is supplied from the PLC.

## 4.2 Name of Each Part

### 4.2.1 Front Panel

#### 1) Display

- F920GOT-K  
Graphic display of 128 × 64 dots  
Character string: 16 characters × 4 lines
- F930GOT/F930GOT-K  
Graphic display of 240 × 80 dots  
Character string: 30 characters × 5 lines
- F940GOT  
Graphic display of 320 × 240 dots  
Character string: 40 characters × 15 lines
- F940WGOT  
Graphic display of 480 × 234 dots    Character string: 60 characters × 14 lines

Example: Front panel of F940GOT

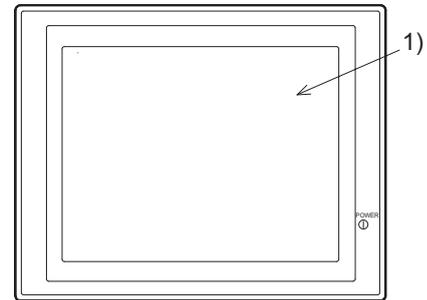

- Alphabets and numbers can be displayed in the size of ×1/2 to ×4 in height and ×1 to ×4 in width.

### 4.2.2 Rear Panel

F920GOT-K

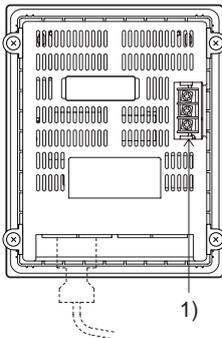

F930GOT-K

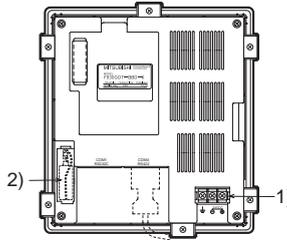

F930GOT

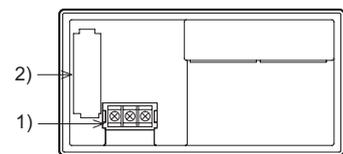

F940GOT

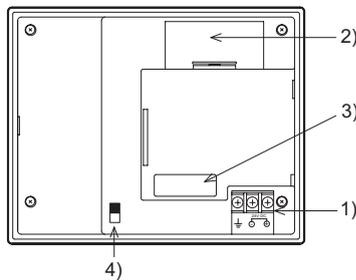

F940WGOT

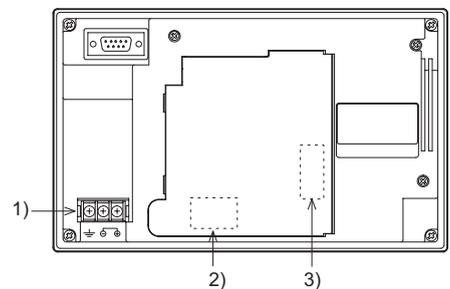

#### 1) Power terminals:

Supply the power to the GOT-F900 and perform the grounding. (Excluding the 5 V type F920GOT-K.)

#### 2) Battery:

Stores the sampling data, the alarm history and the current time.

The screen data is stored in the built-in flash memory, and kept stored even if the life of the battery is expired.

	F930GOT, F930GOT-K	F940GOT, F940WGOT
Battery model name	FX2NC-32BL	PM-20BL

#### 3) Extension interface:

Connects an optional extension equipment.

This interface is used to connect the screen data transfer adapter F9GT-40UMB and write the screen data stored in the EPROM at high speed. (F940GOT)

This interface is used to connect the screen data transfer adapter F9GT-40FMB and transfer the screen data stored in the FLASH memory at high speed. (F930GOT-K, F940GOT, F940WGOT)

#### 4) CN/OP selector switch:

Not used (Set it to "OP" usually.)

1	Introduction
2	Outline
3	Specifications
4	Installation and Wiring of F940GOT
5	Installation and Wiring of Handy GOT
6	Connection of Peripheral Equipment
7	Connection of Two or More GOT Units
8	Connection of MELSEC-F FX Series PLC
9	Connection of MELSEC-A Series PLC
10	Connection of MELSEC-QnA Series PLC

### 4.2.3 Function of Ports

Connect a PLC unit and peripheral equipment to the following ports of the GOT.

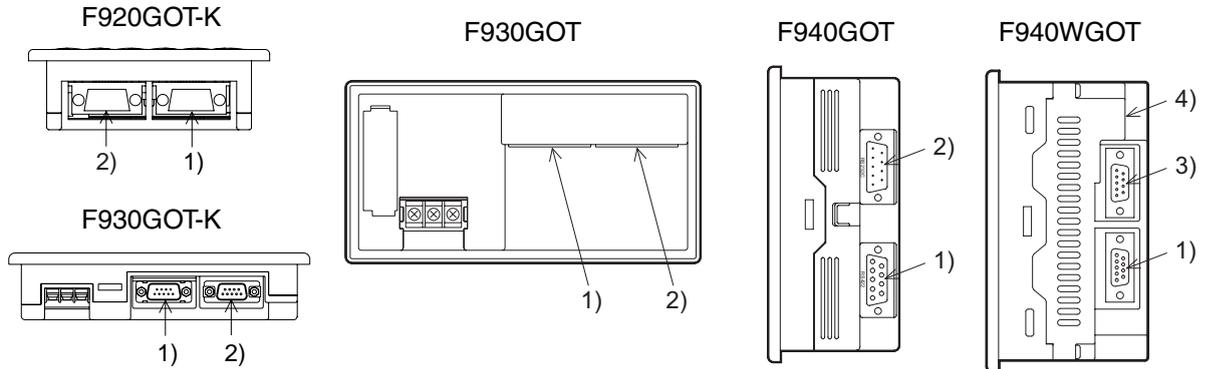

#### 1) PLC port (RS-422) 9-pin D-Sub, female

- Connect here a PLC through RS-422.
- Use this port also to connect two or more GOT units (through RS-422). (excluding the F920GOT-K)

#### 2) Personal computer/PLC port (RS-232C) 9-pin D-Sub, male

- Connect here a personal computer to transfer the screen data created by the screen creation software.
- Use this port also to connect a PLC or microcomputer board through RS-232C. (In the F920GOT-K, only Q Series PLC can be connected.)
- Use this port also to connect two or more GOT units (through RS-232C), a bar code reader or a printer. (excluding the F920GOT-K)
- The two-port interface function is available. (A personal computer which has started up the PLC software can be connected here.)

#### 3) PLC port (RS-232C) 9-pin D-Sub, male

- Connect here a PLC or micro computer board through RS-232C.
- When using the F940WGOT, use this port also to connect two or more GOT units (through RS-232C), a bar code reader or a printer.

**4) Personal computer port (RS-232C) 9-pin D-Sub, male**

- Connect here a personal computer to transfer the screen data created by the screen creation software.
  - This port is not available to connect a PLC.
  - Use this port to connect a printer or bar code reader.
  - Another GOT can be connected here only when the PLC is connected to 3) RS-232C port.
  - The two-port interface function is available. (A personal computer which has started up the PLC software can be connected here.)
- When connecting a PLC through a computer link unit, use the port 1), 2) or 3).  
In the F940WGOT, when connecting a personal computer and transferring the screen data, use the port 4).
  - F940WGOT has two serial ports besides one port for PLC. In connecting two or more GOT units, however, only one of the ports can be used to configure a system. The other port can be used for a printer or a personal computer.

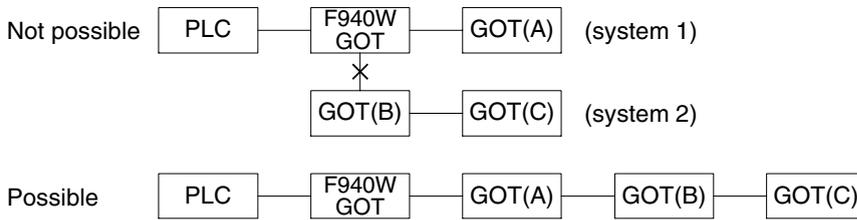

- Only one PLC can be connected to one GOT.



1	Introduction
2	Outline
3	Specifications
4	Installation and Wiring of F940GOT
5	Installation and Wiring of Handy GOT
6	Connection of Peripheral Equipment
7	Connection of Two or More GOT Units
8	Connection of MELSEC-F FX Series PLC
9	Connection of MELSEC-A Series PLC
10	Connection of MELSEC-QnA Series PLC

### 4.3 Outside Dimensions and Panel Face Processing

This paragraph explains the specifications of outside dimensions of the GOT-F900, and the panel cut dimensions in processing the panel face.

#### 4.3.1 Panel Cut Dimension

On the panel face, drill an installation hole of the dimension shown below. In addition to the panel cut dimension, the space for metal fixture is required by approximately 10 mm in the left, right, up and down directions respectively. For the details, refer to "2) Installation space" below.

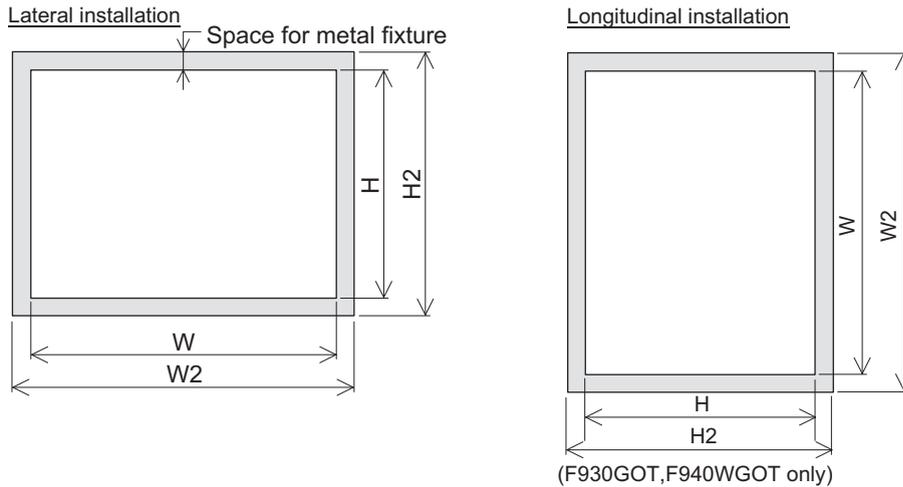

#### 1) Panel cut dimension

Unit: mm (inches)

	F920GOT-K	F930GOT	F930GOT-K	F940GOT	F940WGOT
W	92 (3' 63")	137 (5' 39")	155 (6' 10")	153 (6' 02")	206 (8' 11")
H	119 (4' 69")	66 (2' 60")	170 (6' 69")	121 (4' 76")	124 (4' 88")

- Make sure that the processing accuracy is 0 to +1 mm.
- Make sure that the thickness of the installation panel is 5 mm or less.

#### 2) Installation space (Reference)

For the details, refer to the next page.

Unit: mm (inches)

	F920GOT-K	F930GOT	F930GOT-K	F940GOT	F940WGOT
W2	109 (4' 29")	137 (5' 35")	174 (6' 85")	172 (6' 77")	225 (8' 86")
H2	119 (4' 69")	85 (3' 35")	189 (7' 44")	140 (5' 51")	143 (5' 63")

- The dimension above is offered for reference.



## 4.4 Installation

This section explains the caution on installation of the GOT-F900 on the panel face as well as the installation procedure.

### 4.4.1 Caution on installation

When installing the GOT on the control panel, etc., make sure that the display unit is set at an angle shown in the figure below.

If the GOT is installed at any other angle, the GOT may be deteriorated earlier.

#### 1) F920GOT-K, F930GOT, F930GOT-K and F940GOT

When installing the GOT inside the panel while placing the screen laterally, set the installation angle to 0 to 90° while the temperature inside the panel during operation is 0 to 50°C.

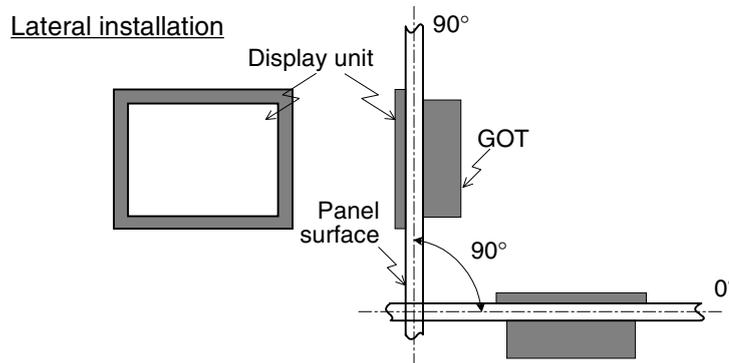

#### 2) F940WGOT

When installing the GOT on the panel surface while placing the screen laterally, set the installation angle to 90° while the temperature inside the panel during operation is 0 to 50°C. When the required installation angle is other than 90°, then the temperature should be 0 to 40°C.

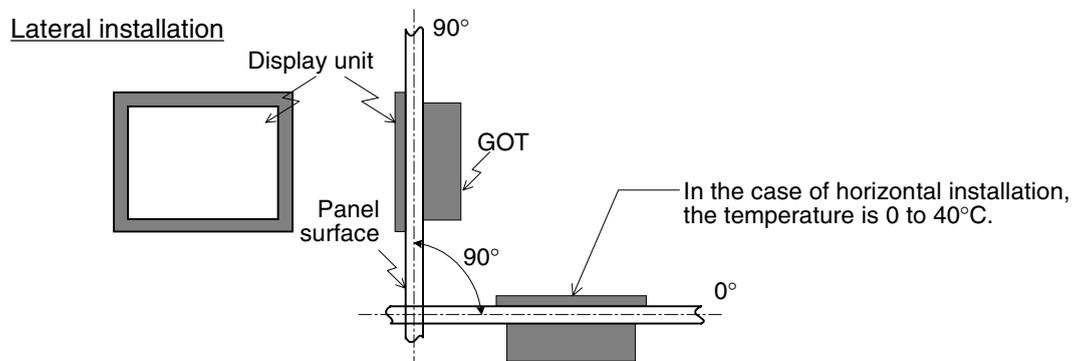

When installing the GOT on the panel surface while placing the screen longitudinally, set the installation angle to 90° while the temperature inside the panel during operation is 0 to 40°C.

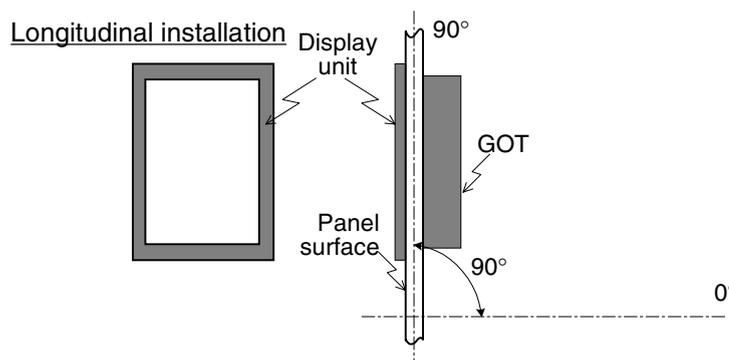

### 4.4.2 Inner dimension of the panel required for installation

When installing the GOT, take into consideration the inner dimension shown below.

- a) PLC cable
- b) Packing

F920GOT-K

Dimensions: mm (inches)

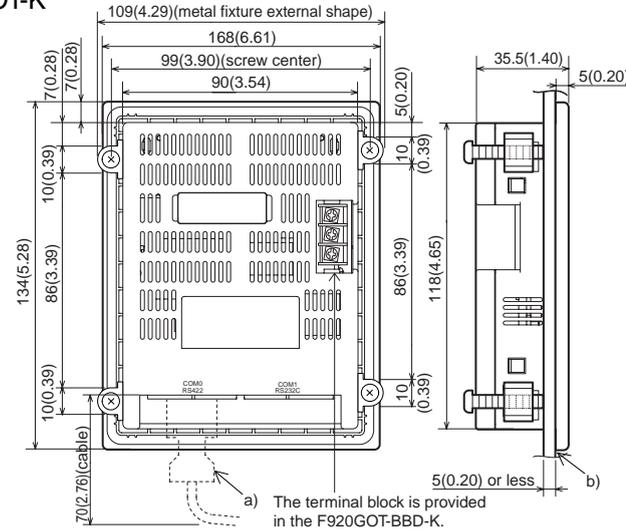

F930GOT-K

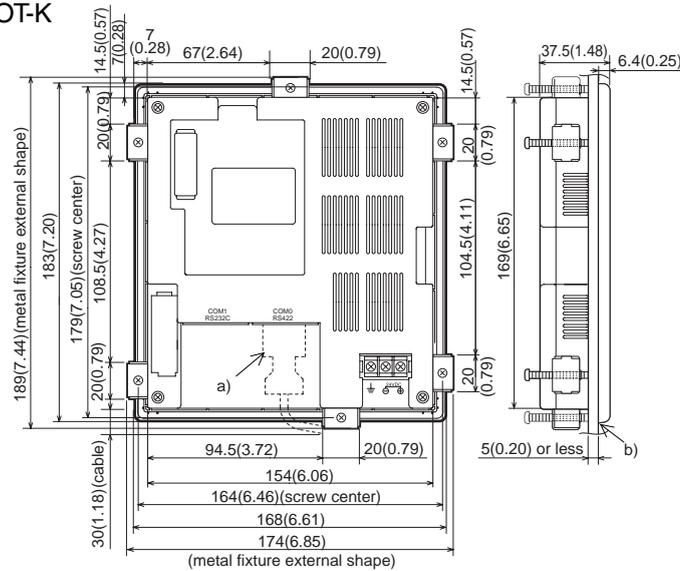

F930GOT

Lateral installation

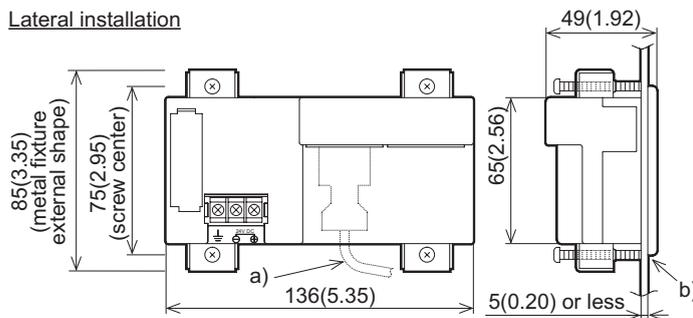

Longitudinal installation

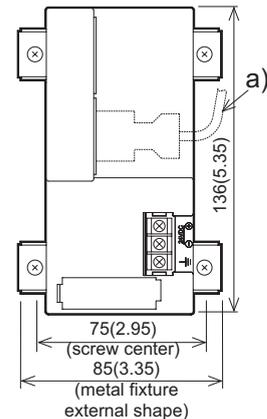

F940GOT

Lateral installation

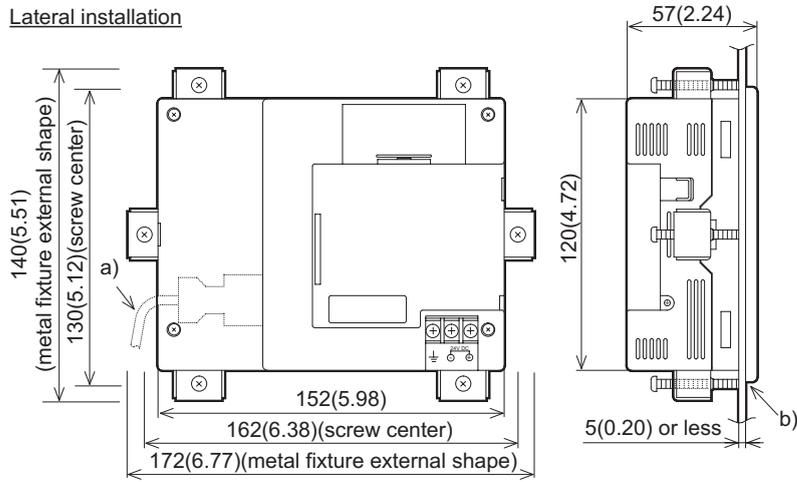

Longitudinal installation

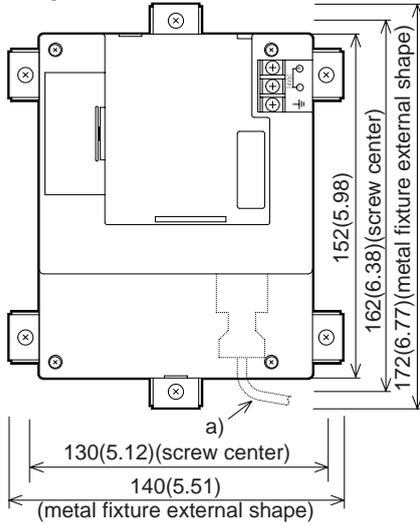

Dimensions: mm (inches)

1	Introduction
2	Outline
3	Specifications
4	Installation and Wiring of F940GOT
5	Installation and Wiring of Handy GOT
6	Connection of Peripheral Equipment
7	Connection of Two or More GOT Units
8	Connection of MELSEC-F FX Series PLC
9	Connection of MELSEC-A Series PLC
10	Connection of MELSEC-QnA Series PLC

F940WGOT

Lateral installation

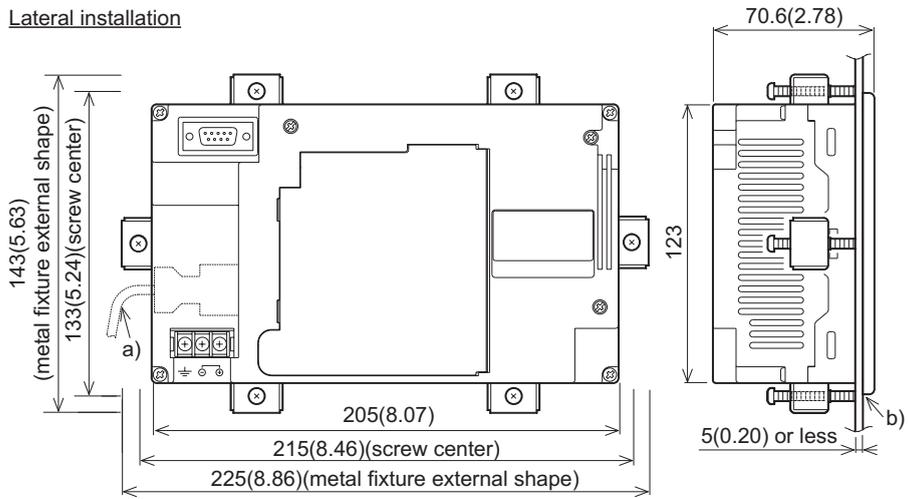

Longitudinal installation

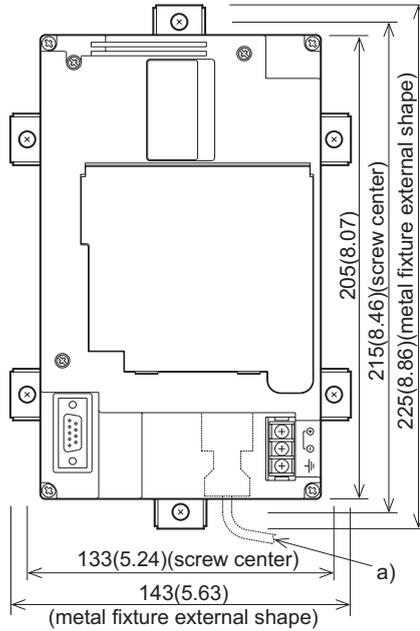

Dimensions: mm (inches)

### 4.4.3 Installation procedure

The GOT-F900 is so designed as to be embedded in the panel. Install the GOT using the procedure shown below. For the panel cut dimension, refer to the previous page.

#### 1) Inserting the GOT into the panel face

Attach a packing to the GOT. Insert the GOT from the front of the panel face.

- a) GOT
- b) Packing
- c) Installation hole

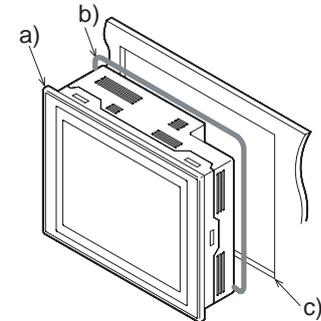

#### 2) Fixing the GOT

Hang the hook of the metal fixture (offered as accessory) to installation hook holes in the GOT. Tighten a tightening bolt (offered as accessory) securely in each position.

The GOT can be fixed in four positions at corners. However, to prevent dusts and water, fix the GOT in six positions (excluding the F930GOT).

- a) Metal fixture
- b) Tightening bolt

\* Make sure that the tightening torque for each tightening bolt is 0.3 to 0.5 N·m.

(0.18 to 0.22 N·m when installing the F920GOT-K)

F920GOT-K

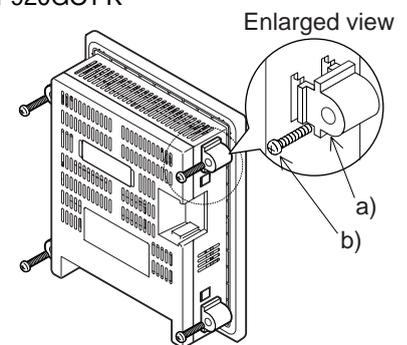

F940GOT

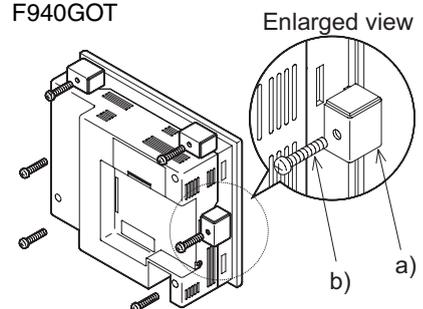

### 4.5 Connector Pin Layout and Signal Name (Excluding the 5 V type F920GOT-K.)

The figure below shows the pin layout in the serial interface connector built in the GOT-F900.

#### F920GOT-K (24 V type)/F930GOT/F930GOT-K/F940GOT/F940WGOT

RS-422

9-pin D-Sub, female

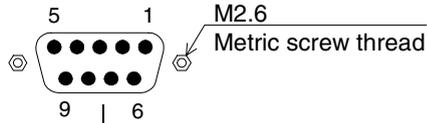

RS-232C

9-pin D-Sub, male

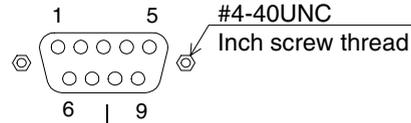

D-sub pin number	RS-422	RS-232C	Application
1	TXD+(SDA)	NC	Signal wire for communication with PLC (For the wiring, refer to the section corresponding to the connected PLC.)
2	RXD+(RDA)	RD(RXD)	
3	RTS+(RSA)	SD(TXD)	
4	CTS+(CSA)	ER(DTR)	
5	SG(GND)	SG(GND)	
6	TXD-(SDB)	DR(DSR)	
7	RXD-(RDB)	RS(RTS)	
8	RTS-(RSB)	CS(CTS)	
9	CTS-(CSB)	User cannot use	

### 4.6 Outline of Internal Wiring

The figure below shows the internal wiring of the GOT-F900.

#### F920GOT-K/F930GOT-K

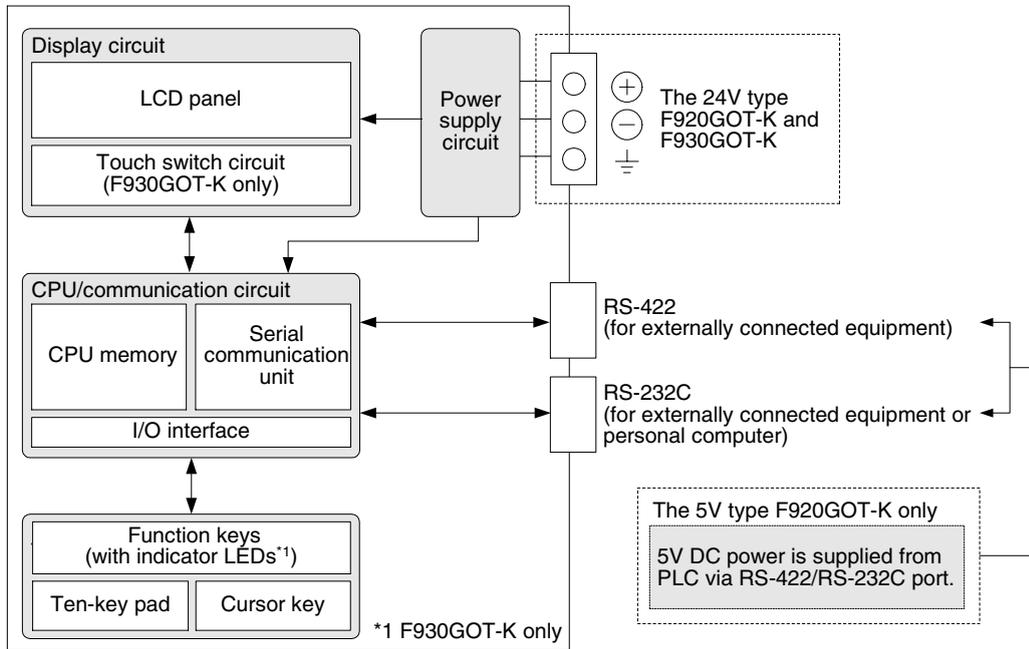

#### F930GOT/F940GOT/F940WGOT

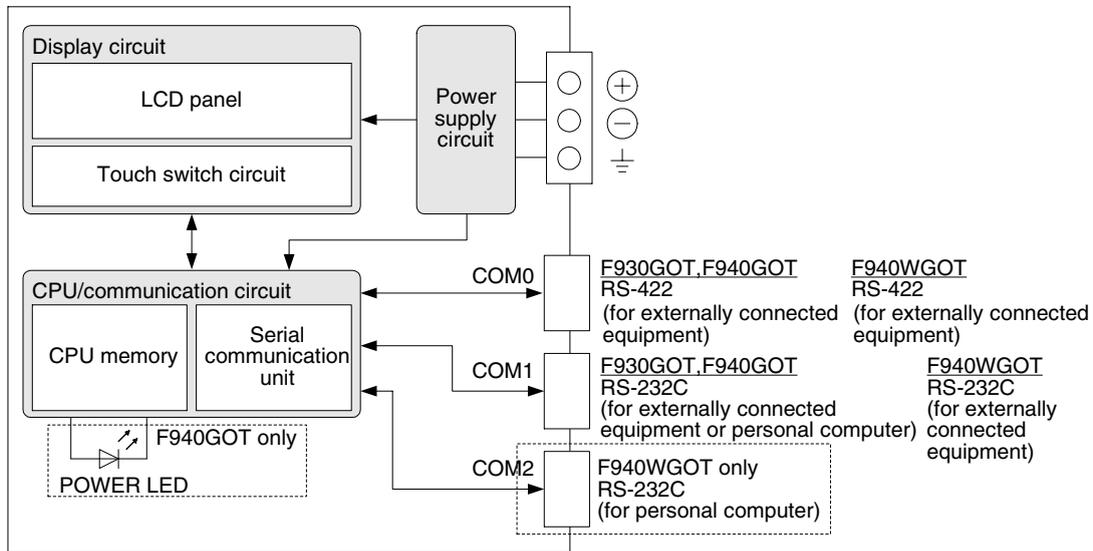

1	Introduction
2	Outline
3	Specifications
4	Installation and Wiring of F940GOT
5	Installation and Wiring of Handy GOT
6	Connection of Peripheral Equipment
7	Connection of Two or More GOT Units
8	Connection of MELSEC-F FX Series PLC
9	Connection of MELSEC-A Series PLC
10	Connection of MELSEC-QnA Series PLC

## 4.7 Wiring for 24V DC and 5V DC Power Supply and Class D Grounding

To the F930GOT/F940(W)GOT, the power is supplied from the PLC or from the external power supply.

### 1) Current consumption in the GOT-F900

The table below shows the current consumption in each case.

GOT-F900	Current consumption	Remarks
F920GOT-BBD5-K	220mA/5V DC	Power is supplied from PLC via communication cable.
F920GOT-BBD-K	80mA/24V DC	
F930GOT-BWD-E	200mA/24V DC	
F930GOT-BBD-K	220mA/24V DC	
F940GOT-LWD-E	390mA/24V DC	
F940GOT-SWD-E	410mA/24V DC	
F940WGOT-TWD-E	650mA/24V DC	At power ON, 750 mA/24V DC maximum is applied.

#### a) In the case of F920GOT-K (5 V type)

5V DC is supplied from the PLC.

The F920GOT-K can be connected to the FX1N-422-BD or FX2N-422-BD extension board mounted on the FX1S/FX1N/FX2N Series PLC.

Before connecting, learn the restrictions described in Chapter 8.

#### b) In the case of F920GOT-K (24 V type), F930GOT and F940GOT

When supplying the power from the service power supply of the FX Series PLC or extension unit, take into consideration the total current supplied to proximity switches and extension blocks. If the total current exceeds the capacity of the service power supply, supply the power from the external power supply. For the FX0/FX0S/FX1S/FX0N Series PLC, an external power supply is required.

#### c) In the case of F940WGOT

The current consumption is as shown in the table above. Supply the power from the external power supply.

### 2) Momentary power failure (excluding only the 5 V type F920GOT-K)

Even if momentary power failure of less than 5ms occurs in the power supply, the GOT-F900 continues the operation.

If long-time power failure or voltage drop occurs, the GOT-F900 stops the operation. When the power supply is recovered, the GOT-F900 automatically displays the title screen and then an user screen.

### 3) Electric wires to be used (excluding only the 5 V type F920GOT-K)

Use electric wires of 0.75mm<sup>2</sup> or more in the wiring of the power supply so that voltage drop does not occur. Use solderless terminals for M3, and tighten them securely with the tightening torque of 0.5 to 0.8 N•m so that troubles are not caused.



4) Recommended feature size of terminal

F920GOT-K (5V type)  
No terminal block is provided.

F920GOT-K (24V type), F940GOT

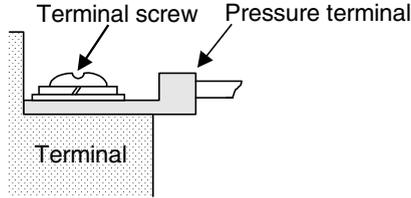
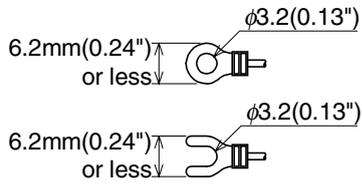

When wiring one cable to a terminal

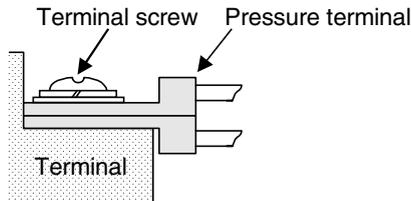
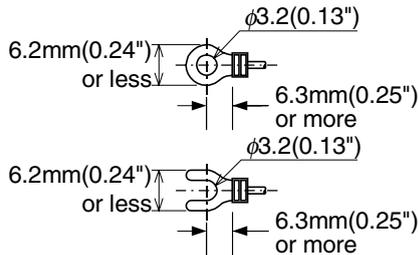

When wiring two cables to a terminal

F930GOT/F930GOT-K/F940WGOT

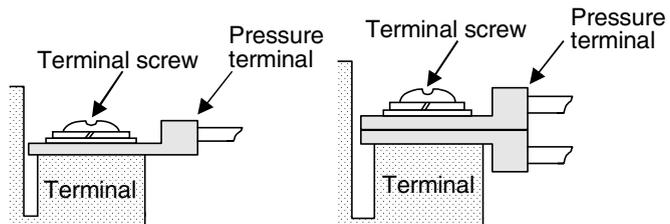
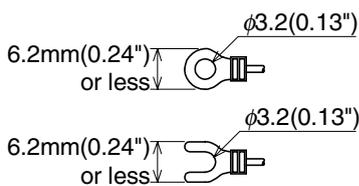

When wiring one cable to a terminal

When wiring two cables to a terminal

5) Wiring

Install wiring from 24V DC power supply and grounding to the terminal block on the rear panel of the GOT-F900.

No wiring is required because power is supplied to the F920GOT-K via a communication cable.

F920GOT-K (24V type)

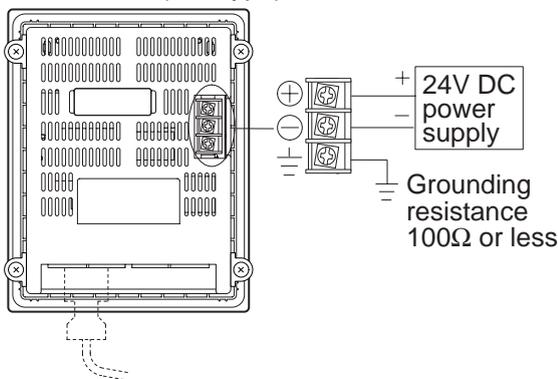

F930GOT, F933GOT

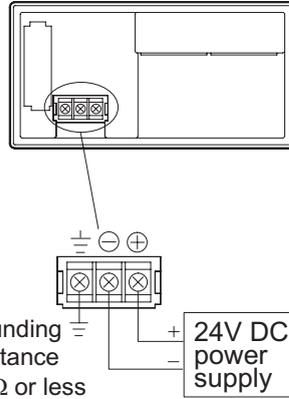

F930GOT-K

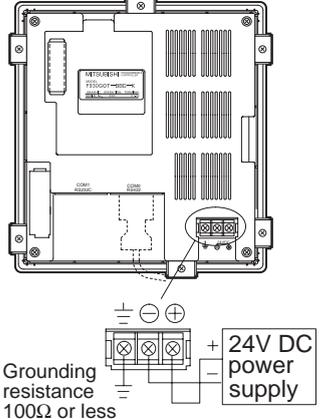

1	Introduction
2	Outline
3	Specifications
4	Installation and Wiring of F940GOT
5	Installation and Wiring of Handy GOT
6	Connection of Peripheral Equipment
7	Connection of Two or More GOT Units
8	Connection of MELSEC-FX Series PLC
9	Connection of MELSEC-A Series PLC
10	Connection of MELSEC-QnA Series PLC

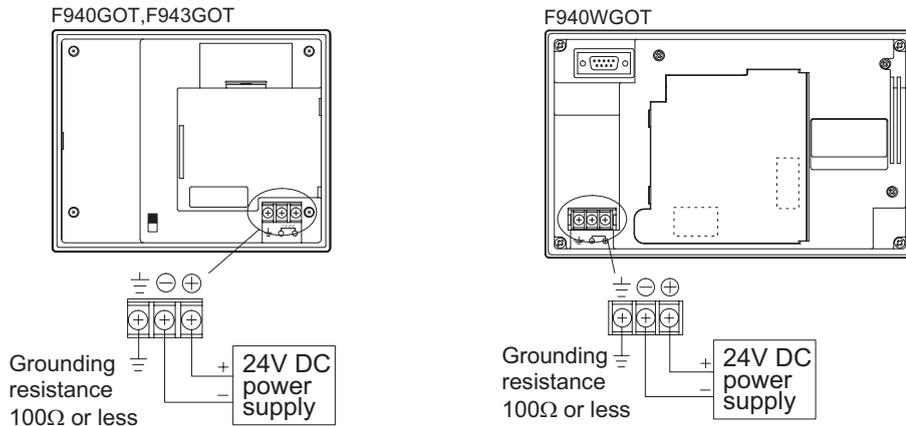

a) Example when the power is supplied from the PLC

Connect the power terminal of the F920GOT-K (24V type)/F930GOT/F930GOT-K/F940GOT to the 24V DC service power supply of the PLC or extension unit.

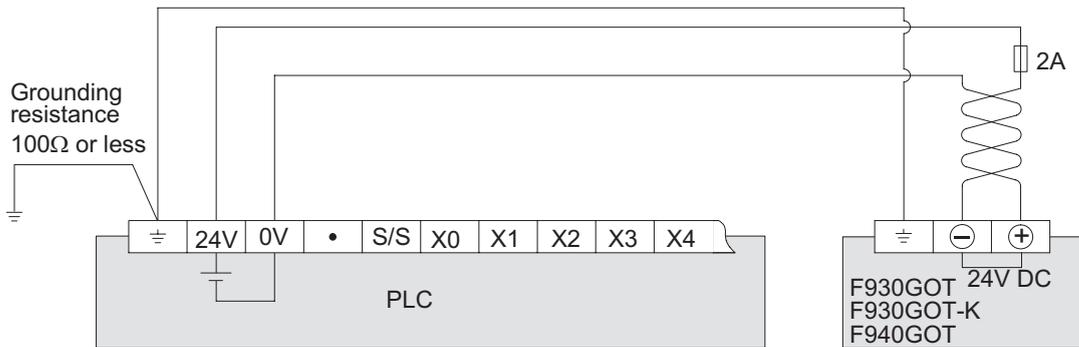

b) Example when the power is supplied from the external power supply

Connect the power terminal of the F920GOT-K (24V type)/F930GOT/F930GOT-K/F940(W)GOT to the 24V DC external power supply.

When the input power supply of the external power supply is different perform dedicated grounding ( ≡ ) to the PLC and to the F930GOT/F930GOT-K/F940(W)GOT separately.

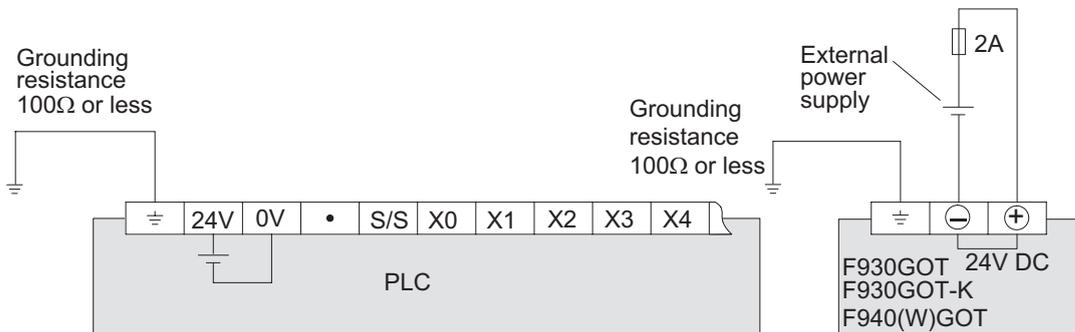

### 4.8 Handling of Function Keys (F1 to F8) (F920GOT-K and F930GOT-K)

The ON/OFF status of the function keys is transmitted to the PLC via a communication cable.

#### Allocation of keys

F920GOT-K

F930GOT-K

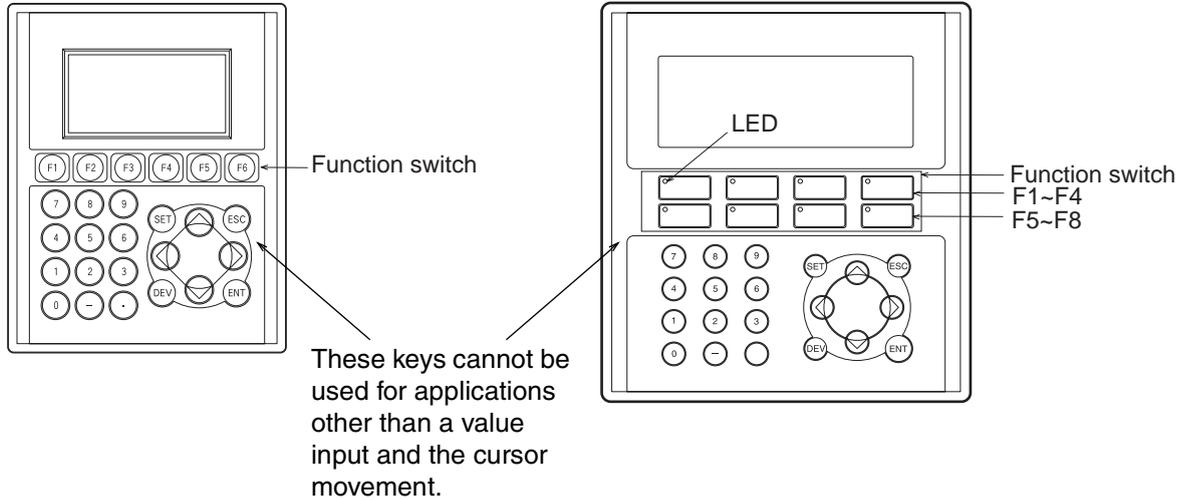

Six function keys (F1 to F6) are provided.

Eight function keys with green LEDs (F1 to F8) are provided.

#### Setting in the screen creation software

Select the followings on the menu in the screen creation software.

		Function of function key	LED indicator on function key
Screen creation software	GT Designer2	Unit of project: "Common"- "Operation Panel" Unit of screen: Right-click the screen No. to be set among base screens displayed in the project workspace, then select "Screen Panel".	"Objects" - "Lamp" - "External Lamp"
	GT Designer	"Common"- "Operation Panel"	"Draw" - "Animation Display" - "Lamp"
	DU/WIN	"View/Project" - "Screen List" - "Keys"	"Objects" - "Indicator" - "Output Indicator"

1	Introduction
2	Outline
3	Specifications
4	Installation and Wiring of F940GOT
5	Installation and Wiring of Handy GOT
6	Connection of Peripheral Equipment
7	Connection of Two or More GOT Units
8	Connection of MELSEC-F FX Series PLC
9	Connection of MELSEC-A Series PLC
10	Connection of MELSEC-QnA Series PLC

### 4.8.1 Use of function keys

This section explains the use of the function keys and the indicator LEDs (only in the F930GOT-K).

#### 1) Wiring of function keys

No wiring of the function keys is required because the keys and the connected equipment (PLC) communicate via a communication cable.

#### 2) Input of function keys

The operations of the function keys (alternate/momentary, set/reset, screen changeover) can be set in the screen creation software.

The LED is turned ON/OFF by turning ON/OFF the devices allocated to each function switch in reference to Allocation of device to control LED below.

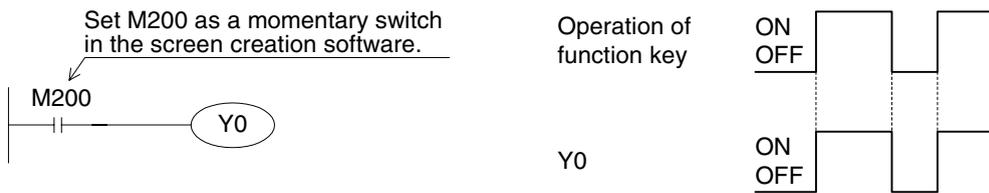

#### 3) Lighting of LEDs on function keys (Available in the F930GOT-K)

No wiring of the LEDs (1 to F8) is required because the LEDs and the connected equipment (PLC) communicate via a communication cable. A green LED is lit when the device allocated to the function key using the screen creation software is turned ON.

##### a) Allocation of device to control LED

Device	Function key
M100	Function key SW1 Green
M101	Function key SW2 Green
M102	Function key SW3 Green
M103	Function key SW4 Green
M104	Function key SW5 Green
M105	Function key SW6 Green
M106	Function key SW7 Green
M107	Function key SW8 Green

← Set this device using the screen creation software. The LEDs for the function keys can be allocated successively.

##### b) Setting in creation software

The devices to display the indicator LEDs on function keys should be set in the screen creation software.

For details, refer to Setting of connected equipment for GOT described later.

##### c) Program example

The indicator LEDs on the function keys can be controlled by the PLC by turning ON/OFF the devices allocated in the screen creation software.

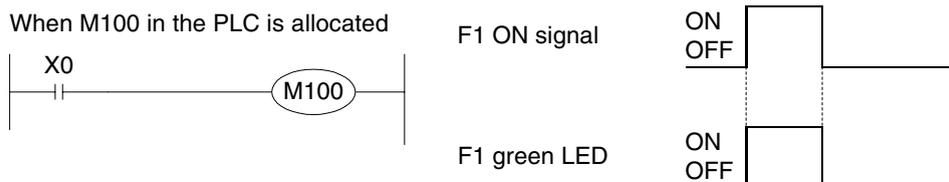

### 4.8.2 Preparation of Function Key Name Sheet (Available in the F930GOT-K)

This section explains how to prepare the function key name sheet.

#### 1) Preparing the name sheet

- a) Make the mount sheet in reference to the following dimensions and prepare an OHP sheet (transparent and colorless sheet).
- b) Write down the names of the switches used on the mount sheet.

Function key

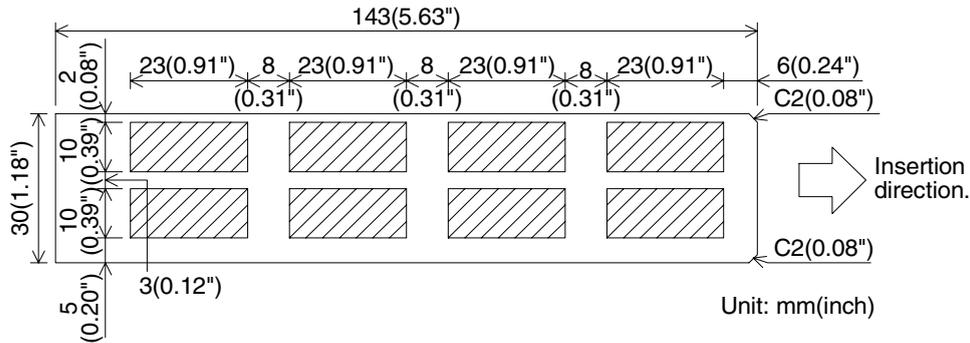

Note: The shaded parts indicate the effective range for characters.

- c) When the work in b) is completed, copy the contents of the name sheet base on an OHP sheet in the actual dimensions (100%) using a copy machine. When using a different OHP sheet, use the following type. Make sure that the selected OHP sheet can be used in a copy specification.

[Recommended OHP sheet]  
 Material: Polyester film  
 Thickness: 0.1mm (0.004")

#### 2) Attaching the sheet

Insert it into the following position shown below of the F930GOT-K.

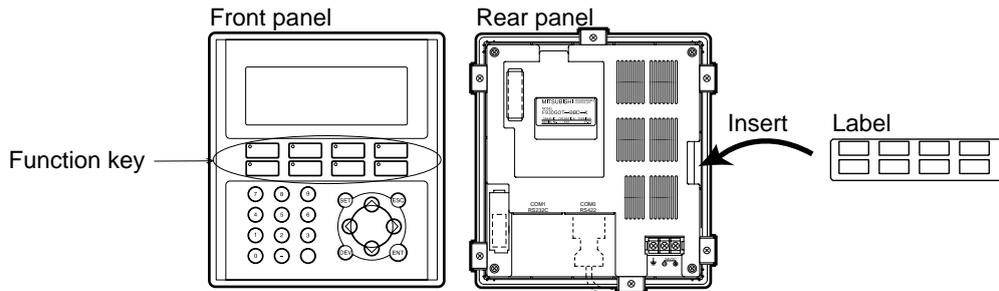

1	Introduction
2	Outline
3	Specifications
4	Installation and Wiring of F940GOT
5	Installation and Wiring of Handy GOT
6	Connection of Peripheral Equipment
7	Connection of Two or More GOT Units
8	Connection of MELSEC-F FX Series PLC
9	Connection of MELSEC-A Series PLC
10	Connection of MELSEC-QnA Series PLC

### 4.8.3 Cautions on use

With regard to the function keys (Operation Panel), the priority is given to the base screen and overlap windows.

If there are two or more types of setting, only the setting on a screen having higher priority is valid in the unit of function key No.

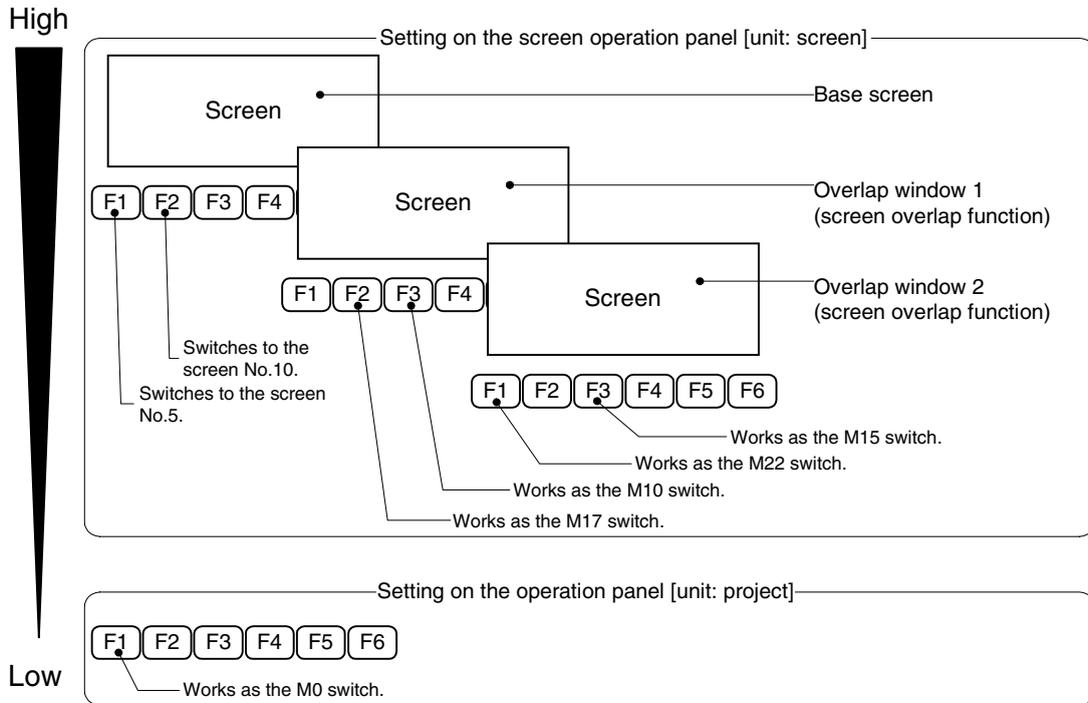

Suppose that the screens shown above are overlapping.

- For the [F1] key, only the setting "Switches to the screen No. 5." set in the unit of screen is valid.
- For the [F2] key, the setting "Switches to the screen No. 10." set on the base screen is valid.
- For the [F3] key, only the setting "Works as the M10 switch." set on the overlap window 1 is valid.

4.8.4 Label pattern (F930GOT-K)

Copy this pattern to the OHP sheet offered as an accessory.

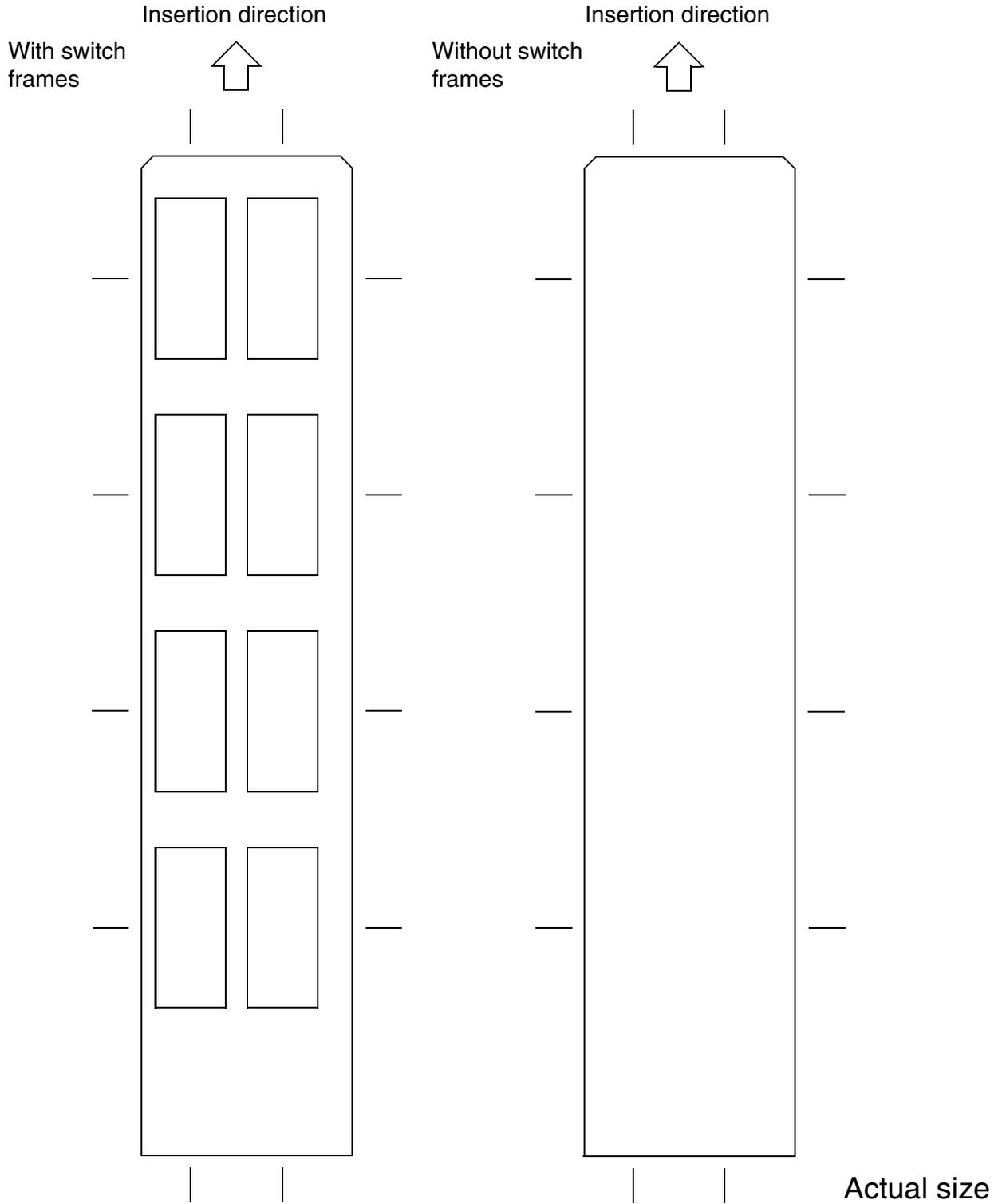

1	Introduction
2	Outline
3	Specifications
4	Installation and Wiring of F940GOT
5	Installation and Wiring of Handy GOT
6	Connection of Peripheral Equipment
7	Connection of Two or More GOT Units
8	Connection of MELSEC-F FX Series PLC
9	Connection of MELSEC-A Series PLC
10	Connection of MELSEC-QnA Series PLC

### 4.9 Setting of Connected Equipment for GOT

The setting in the screen creation software is required to turn on and off the function keys and LED display using the connected equipment. This section describes the setting method.

#### 1) GOT-F900 Series

No setting is enabled on the GOT. Set items in either one of the screen creation software mentioned below.

#### 2) GT Designer2

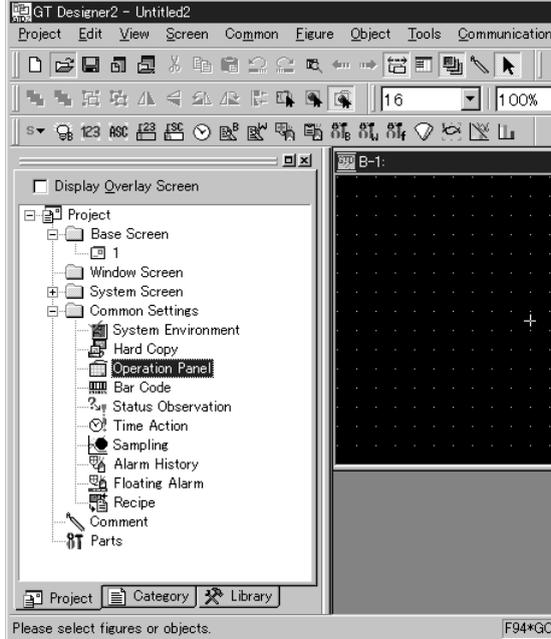
Operation		Display (screen name)
[Setting]	a) It is supposed that the GT Designer2 has started up and the screen data to be set is read. b) Open a user screen to be set. Any screen is available as far as it has been already created. Select and display the base screen (B-1) in this example.	The "Lamp" dialog box appears.
[LED setting]  Only in F930GOT-K	c) Select "Object"->"Lamp"->"External" on the menu.   d) Click the [Dev..] button, input a bit device to be assigned, then click [OK]. Refer to Caution on setting of "Lamp (External)" described later.	
[Switch setting] Function key	e) To a function key, a same function can be set in the entire project, or a different function can be set for each screen. The required procedure is as described below. <u>Unit of project (common on all screens)</u> From the menu bar, select "Common"->"Operation Panel". Or double-click "Operation Panel" in the tree displayed in the project work space.  	"Operation Panel" dialog box appears.

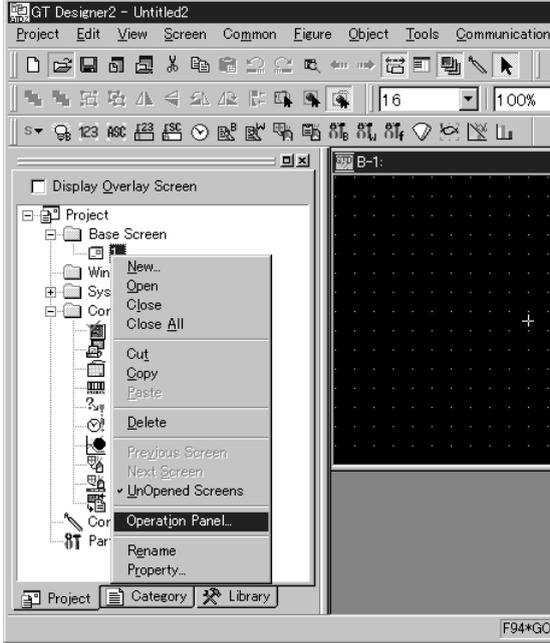
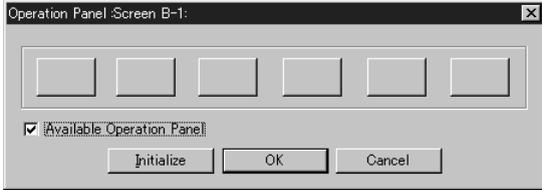
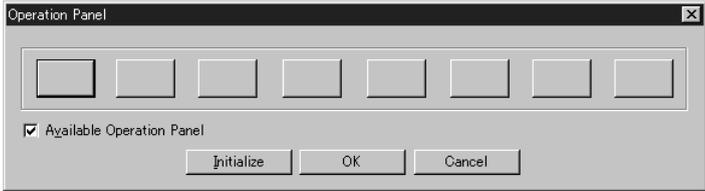

	Operation	Display (screen name)
	<p><b>Unit of screen (individual)</b>                      Select "Project"-&gt;"Base Screen" from the project work space, left-click the screen No. to be set, then select "Operation Panel" on the submenu.</p>  <p>In the case of F920GOT-K</p>  <p>In the case of F930GOT-K</p>  <p>f) Click "Available Operation Panel" to display the check mark (✓).                      g) Click a box indicating a function key, and set its function.                      Refer to "Function key setting" described later.</p>	

1	Introduction
2	Outline
3	Specifications
4	Installation and Wiring of F940GOT
5	Installation and Wiring of Handy GOT
6	Connection of Peripheral Equipment
7	Connection of Two or More GOT Units
8	Connection of MELSEC-F FX Series PLC
9	Connection of MELSEC-A Series PLC
10	Connection of MELSEC-QnA Series PLC

**Caution on setting of "Lamp (External)"**

1. The contents of "Lamp (External)" you have set are not displayed on the screen.
2. The setting of "Lamp (External)" is valid only in the F930GOT-K and Handy GOT. Never set it in any other series.
3. Set only one lamp for all screens of the created screen data.
4. Make sure that the bit device assigned on the "Basic" tab in "Lamp" dialog box is not included in the read/write device range set in "Common"- "System Information".

**Function key setting**

1. "Available Operation Panel" check box is valid only in the F920GOT-K, F930GOT-K and Handy GOT. Do not set it in any other series.
2. Several boxes displayed on the "Operation Panel" dialog box (shown in the table below) correspond to the function keys. Note that key codes cannot be set to the function keys though the contents of operation setting are equivalent to those for touch switches.

**Setting up the function keys (for the F920GOT-K)**

The function keys in the F920GOT-K are assigned as shown below.

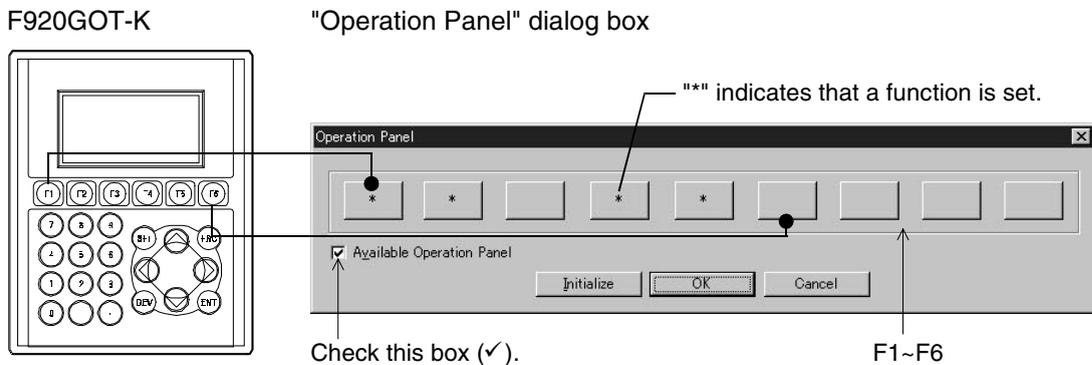

**Setting up the function keys (for the F930GOT-K)**

The function switches in the F930GOT-K are assigned as shown below.

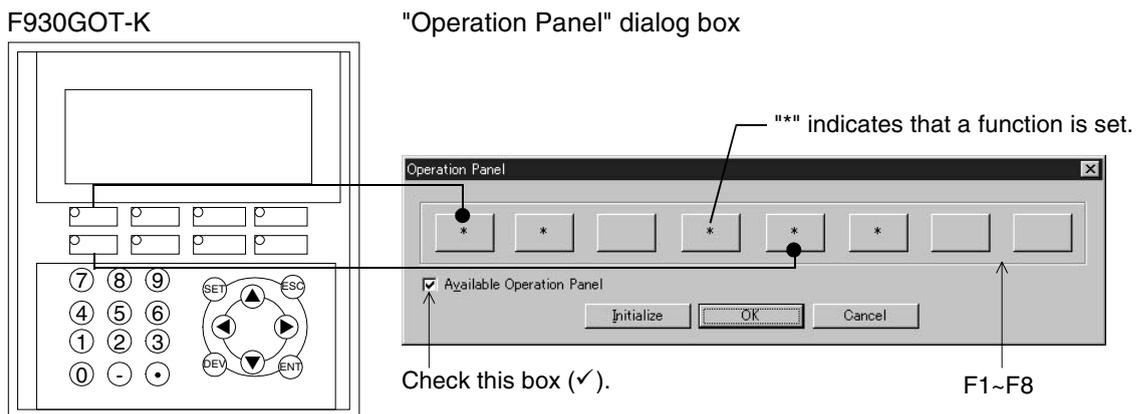

Screen display of GT Designer2

""\*"" indicates that a switch operation is set.

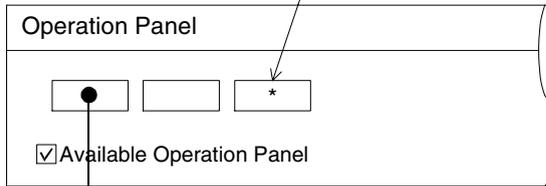

Click a box indicating a function key, then set its functions (example: F1).

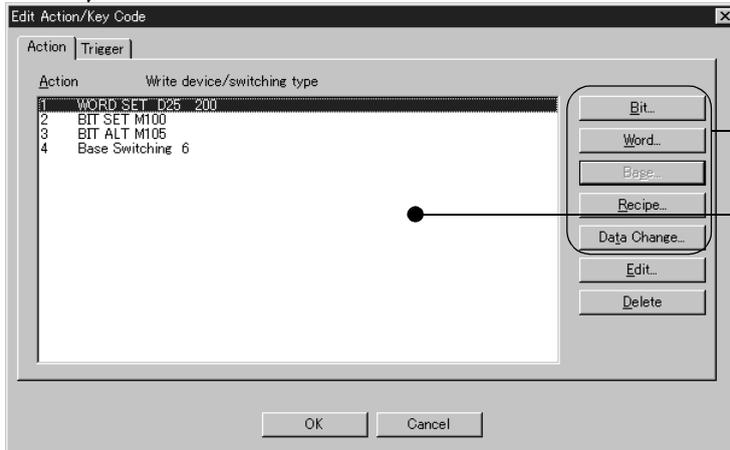

Switch functions

Currently set switch functions are displayed.

1	Introduction
2	Outline
3	Specifications
4	Installation and Wiring of F940GOT
5	Installation and Wiring of Handy GOT
6	Connection of Peripheral Equipment
7	Connection of Two or More GOT Units
8	Connection of MELSEC-F FX Series PLC
9	Connection of MELSEC-A Series PLC
10	Connection of MELSEC-QnA Series PLC

3) GT Designer

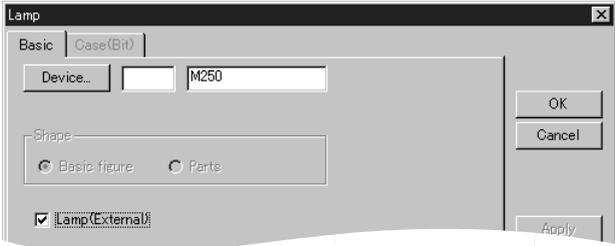
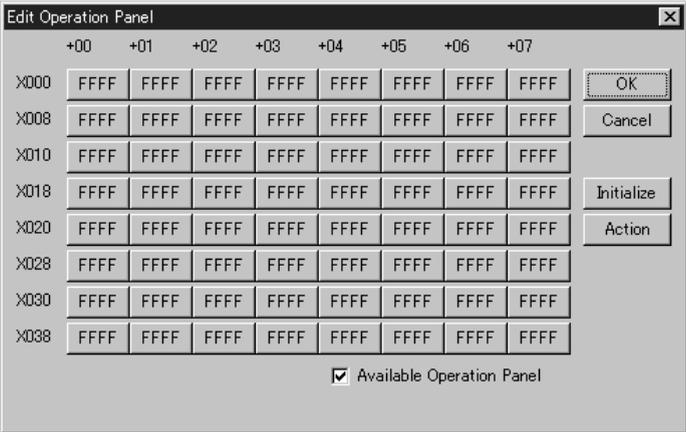
Operation		Display (screen name)
[Setting]	a) It is supposed that the GT Designer has started up and the screen data to be set is read. b) Open a user screen to be set. Any screen is available as far as it has been already created. Select and display the base screen (B-1) in this example.	
[LED setting] Only in F930GOT-K	c) Select "Draw"->"Animation Display"->"Lamp" on the menu.  d) On the "Basic" tab, click "Lamp (External)" to display the check mark (✓), click the [Device] button, input a bit device to be assigned, then click [OK]. Refer to Caution on setting of "Lamp (External)" described later.	The "Lamp" dialog box appears.
[Switch setting] Function key	e) On the menu, select "Common"->"Operation Panel".  f) Click "Available Operation Panel" to display the check mark (✓). Refer to "Function key setting" described later.	"Edit Operation Panel" dialog box appears.

**Caution on setting of "Lamp (External)"**

1. The contents of "Lamp (External)" you have set are not displayed on the screen.
2. The setting of the "Lamp (External)" check box is valid only in the F930GOT-K and Handy GOT. Never set it in any other series.
3. Set only one lamp for all screens of the created screen data.

**Function key setting procedure and cautions**

1. The check box of "Available Operation Panel" is valid only in the F920GOT-K, F930GOT-K and Handy GOT. Do not set it in any other series.
2. The operations of the keys (F1 and others) can be set using devices (+00 ~ of X000) in "Edit Operation Panel" in the screen creation software.  
 Note that key codes cannot be set to the function keys though the contents of operation setting are equivalent to those for touch switches.  
 Note also that device names of X000 do not indicate device names of the connected equipment (PLC).

**Allocation table of function key**

		+00	+01	+02	+03	+04	+05	+06	+07
F920GOT-K	X000	F1	F2	F3	F4	F5	F6	-	-
F930GOT-K	X000	F1	F2	F3	F4	F5	F6	F7	F8

**Screen display of GT Designer**

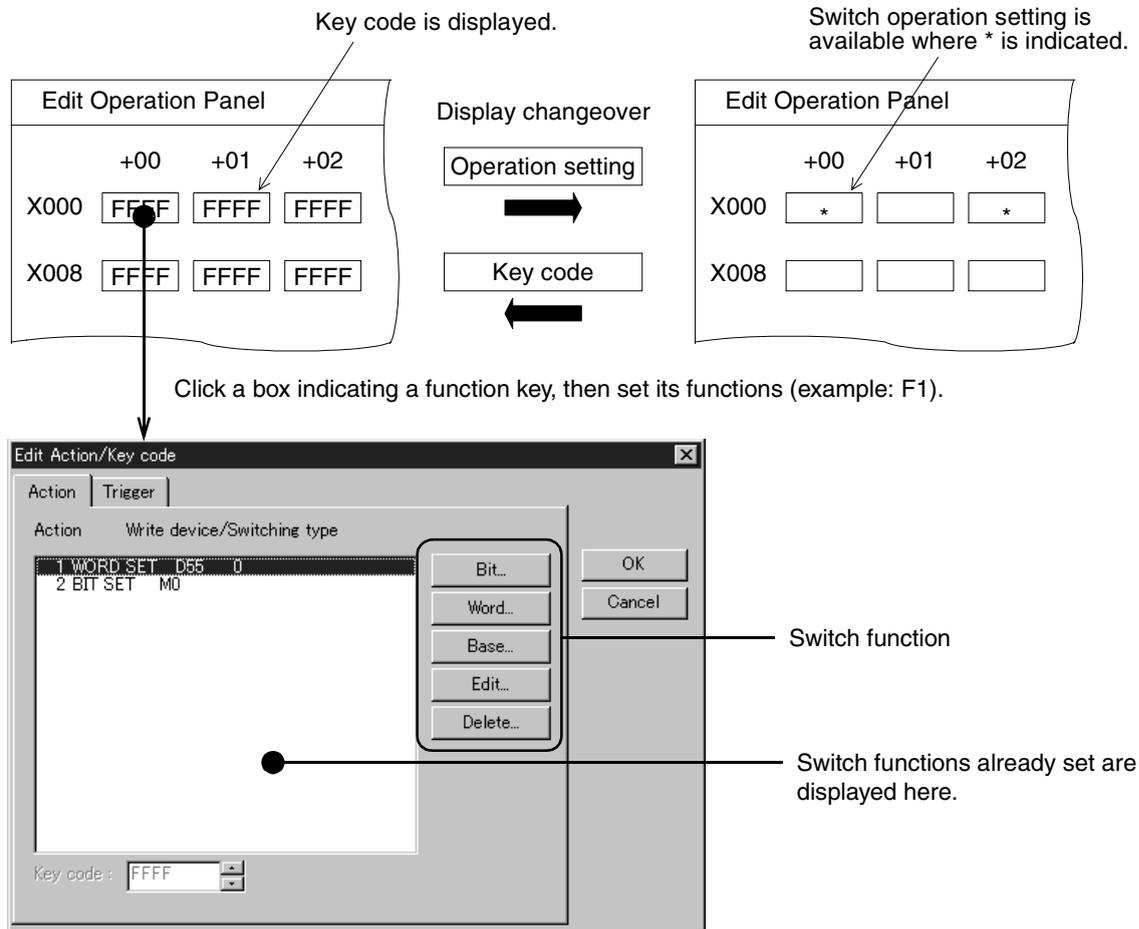

4) DU/WIN

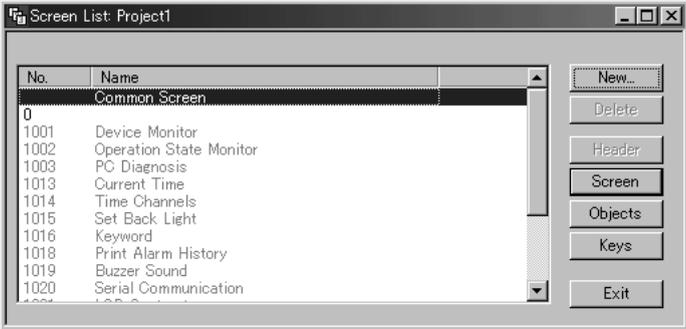
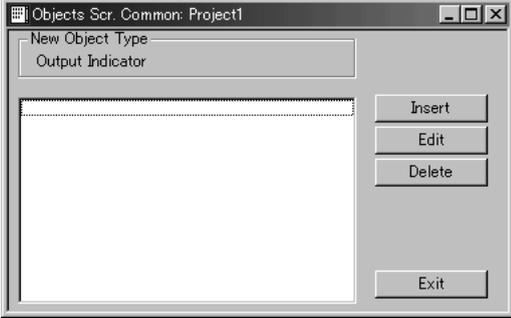
	Operation	Display (screen name)
<p>[Setting]</p>	<p>a) It is supposed that the DU/WIN has started and the screen data to be set has been read.</p> <p>b) Select "Common Screen" on the "Screen List" window (highlighted when clicked).</p>  <p>If the window is closed, select "View/Project"- "Screen List" on the menu.</p>	
<p>[LED setting] Only in F930GOT-K</p>	<p>The LEDs for the function switches are set on "Common Screen".</p> <p>c) Click the [Objects] button.</p> <p>d) Select "Object"- "Indicator"- "Output Indicator" on the menu.</p> 	<p>The "Objects Scr. Common" window appears.</p> <p>"Output Indicator" is displayed in the "New Object Type" field on the "Objects Scr. Common" window.</p>
	<p>e) Click the [Insert] button.</p>  <p>Input a bit device to be assigned, and click [OK]. Refer to Caution on setting of "Output Indicator" next page. Close all windows except the "Screen List" window.</p>	<p>The "Output Indicator" dialog box appears.</p>
<p>[Switch setting]</p>	<p>f) Select "Common Screen" or "User Screen" on the "Screen List" window (by clicking it to be highlighted). To enable the switch function for all the screens, select "Common Screen". To enable it for an user screen, select an arbitrary screen. If the "Screen List" window is closed, select "View/Project"- "Screen List" on the menu bar.</p>	

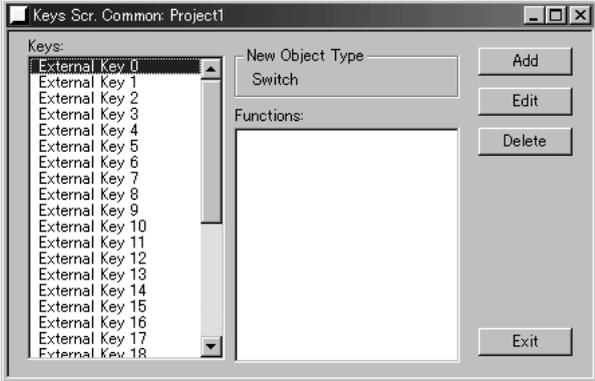
Operation		Display (screen name)
[Switch setting]	<p>g)Click the [Keys] button.</p>  <p>h)Allocate a switch operation to an External Key (n) in the "Keys" list pressing the [Add] button. Refer to Setting of function key below.</p>	The "Keys Scr. Common" window appears.

**Caution on setting of "Output Indicator"**

- 1.The contents of "Output Indicator" you have set are not displayed on the screen.
- 2.The setting of "Output Indicator" is valid only in the F930GOT-K and Handy GOT. Never set it in any other series.
- 3.Set "Output Indicator" only on the common screen. Even if it is set on a user screen, it does not function.
- 4.Make sure that the bit device assigned on the "Output Indicator" dialog box is not included in the bit device range in set "View/Project"->"System Settings"->"Interface Devices".

**Function key setting procedure and cautions**

The switch operations can be set to devices (external keys 0 to 7) corresponding to F1 to F8. The setting method and operations are the same as 'function allocation' for touch keys, however, note that no key code setting is available.

**Table of function key allocation**

DU/WIN	F920GOT-K	F930GOT-K
External Key 0	F1	F1
External Key 1	F2	F2
External Key 2	F3	F3
External Key 3	F4	F4
External Key 4	F5	F5
External Key 5	F6	F6
External Key 6	Cannot be used	F7
External Key 7	Cannot be used	F8

**Screen of DU/WIN**

\*\*\* mark indicates switch operation has already allocated.

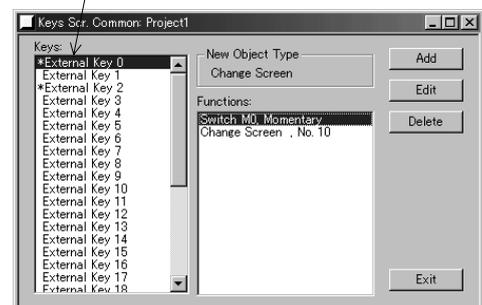

1 Introduction

2 Outline

3 Specifications

4 Installation and Wiring of F940GOT

5 Installation and Wiring of Handy GOT

6 Connection of Peripheral Equipment

7 Connection of Two or More GOT Units

8 Connection of MELSEC-F FX Series PLC

9 Connection of MELSEC-A Series PLC

10 Connection of MELSEC-QnA Series PLC

### 4.10 Caution on Use

#### 1) Connection between GOT-F900 and PLC

- a) One GOT cannot be connected to multiple PLCs.  
Only one PLC must be connected.

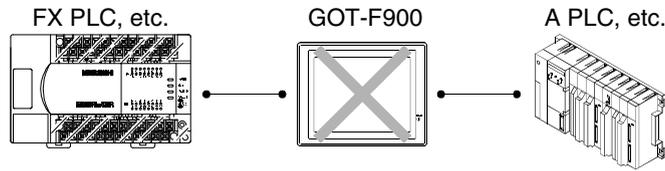

- b) F940WGOT cannot be used when connected both to a bar code reader and a printer.  
Either a bar code reader or a printer must be connected.

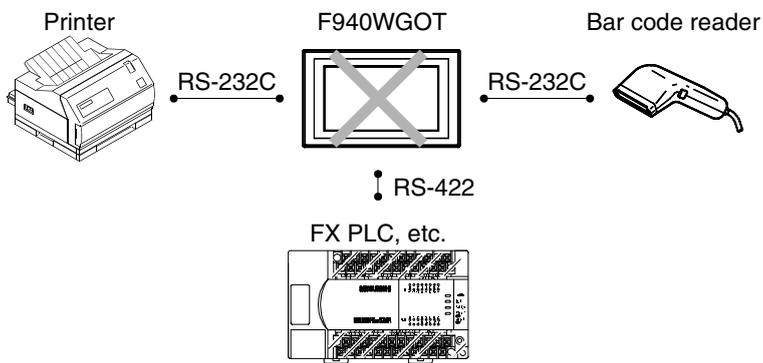



## 5. Installation and Wiring of Handy GOT

This section explains installation, wiring and usage of the operation switches and the grip switch as well as control of the LEDs for switch pressing confirmation in the following order.



### Cautions on Installation

- Use the Handy GOT in the environment for the general specifications described in this manual. Never use the Handy GOT in a place with dusts, soot, conductive dusts, corrosive gas or flammable gas, place exposed to high temperature, condensation, direct sunlight, wind and rain, or place subject to vibrations and impacts.  
If the Handy GOT is used in an unfavorable place described above, electrical shock, fire or malfunction, damages or deterioration of the Handy GOT may be caused.
- Never drop cutting chips and electric wire chips into the ventilation window of the Handy GOT when you drill screw holes or perform wiring.  
Otherwise, fire, failure or malfunction may be caused.
- Connect connection cables securely to the specified connectors while the power is turned OFF. Imperfect connection may cause malfunction or failure.
- When connecting cables, pay attention to the contents described in this section. Especially, attach the rear cover so that PCBs inside the Handy GOT are not interfered with connection cables.



### Caution on Wiring

- Make sure to shut down all phases of the power supply outside the Handy GOT before starting the installation or wiring work.  
Otherwise, electrical shock and damages of the Handy GOT may be caused.
- Make sure to attach the rear cover to the Handy GOT before turning on the power and starting operation after the installation or wiring work.  
Otherwise, electrical shock may be caused.



### Caution

- The Handy GOT has the DC power supply specifications. Connect the DC power cable to the dedicated terminals described in this manual.  
If the AC power supply is connected to power terminals or an operation/emergency stop switch, the Handy GOT may be burnt.
- Before turning on the power or starting operation after the installation or wiring work, make sure to attach the rear cover to the Handy GOT.  
If the rear cover is not attached, you may get electrical shock.
- Perform Class D grounding to the ground cable (FG) of the Handy GOT. However, never perform common grounding with the strong electrical system.



### Caution on Design

- While executing monitoring in the GOT (GOT-F900), if a communication error (including disconnection of a cable) occurs, communication between the GOT and the PLC CPU is interrupted and the GOT is disabled.  
When establishing the system configuration using the GOT, make sure that a switch which gives a significant operation to the system is executed from any equipment other than the GOT while postulating communication error in the GOT. Otherwise, accidents may be caused by incorrect output and malfunction.



### Caution

- Do not bind the control cable and the communication cable together with the main circuit and the power line. Keep such cables off the main circuit and the power line by 100 mm or more.  
Otherwise, malfunction may be caused by noise.
- Make sure to press touch keys on the display screen with hand. If touch keys are subject to an excessive force or pressed by a hard or sharp object, they may fail.

**Note**

- Even if momentary power failure of less than 5 ms occurs in the power supply, the Handy GOT continues the operation.  
If long-time power failure or voltage drop occurs, the Handy GOT stops the operation. When the power supply is recovered, the Handy GOT restarts the operation.

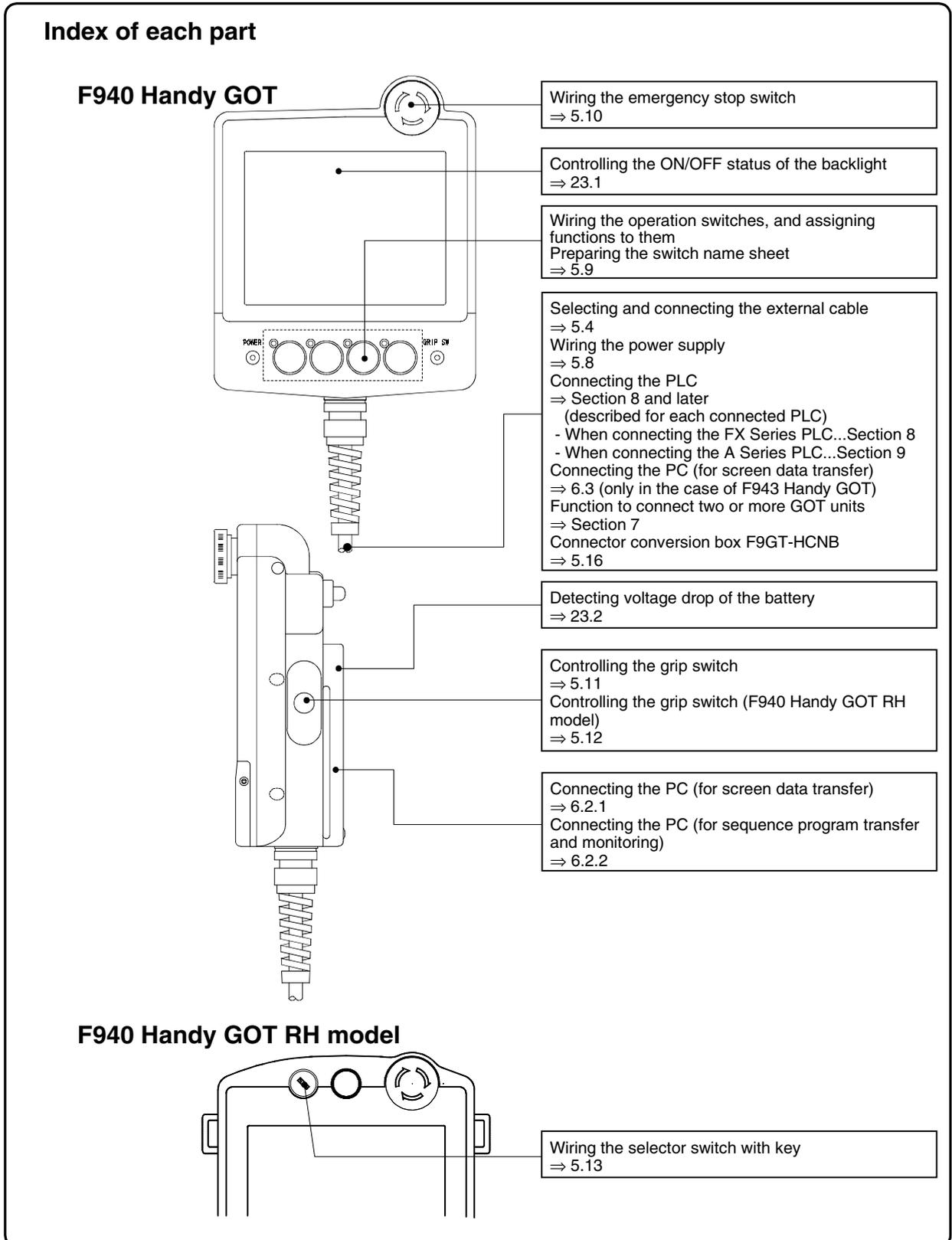

## Wiring and setting procedures

This section introduces the procedure to connect the Handy GOT to connected equipment such as PLC.

### 1. Preparation

Item name	Description	Reference
Outline of Connection	You can learn the outline of the connection method.	5.1
Name of each Part	You can learn the name of each part of the Handy GOT.	5.2
Outside Dimensions and Installation	You can learn the outside dimensions of the Handy GOT and the installation method according to the operation type.	5.3
Selection and Installation of External Cable	You can select cables. This section introduces the procedure to connect cables to the Handy GOT. When preparing a cable, you can learn signal names of connectors and untied wires.	5.4
Processing Panel Face of Control Box or Cabinet	You can learn the dimension of the processing on the panel face required to use the Handy GOT with attachment to and removal from the panel face. This section introduces types of relay cables.	5.5
Pin Layout and Signal Allocation of Connector for Serial Communication and Operation Switches	You can check the signal allocation of connector or untied wires when preparing a cable.	5.6
Connector Conversion Box F9GT-HCNB	You can learn the name of each part, installation, and connector specifications.	5.16

### 2. Wiring

Item name	Description	Reference
Outline of Internal Wiring	You can check block diagrams of portions requiring wiring and the internal wiring.	5.7
Wiring for 24V DC Power Supply and Class D Grounding	You can check the methods to wire the 24V DC power supply and perform Class D grounding.	5.8
Wiring and Handling of Operation Switches SW1 to SW4	You can learn how to use and wire the operation switches. (Setting in the screen creation software is required.)	5.9
Wiring and Handling of Emergency Stop Switch (ES1)	You can learn how to use and wire the emergency stop switch.	5.10
Handling of grip switch (excluding RH model)	You can learn how to use the grip switch.	5.11
Handling of grip switch (RH model only)	You can learn how to use the grip switch.	5.12
Handling of Keylock Switch	You can learn how to use the keylock switch (RH model only).	5.13

### 3. Setting

Item name	Description	Reference
Setting of Connected Equipment for GOT	Using the screen creation software, you can enable the operation switch LEDs and the grip switch.	5.14

#### 4. Others

Item name	Description	Reference
Connection Diagram of Handy GOT Operation Switches and Power Supply	You can confirm connection to confirm continuity of relay cables, etc.	5.15
Troubleshooting	You can learn actions to be taken when an operation switch, emergency stop switch or grip switch of the Handy GOT is disabled.	5.17
How to Read Manual for Handy GOT RH model	You can refer to connection diagrams with the PLC of the Handy GOT, then understand them for the RH model.	5.18

### 5.1 Outline of Connection

The following shows the connection methods depending on whether the Handy GOT is attached and removed or wired directly.

"□" of the GOT model name indicates 0 or 3.

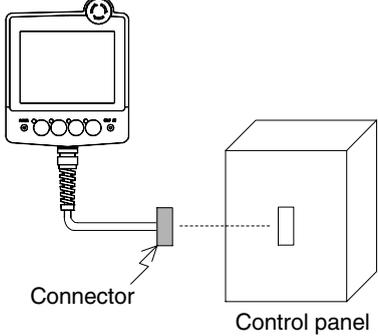
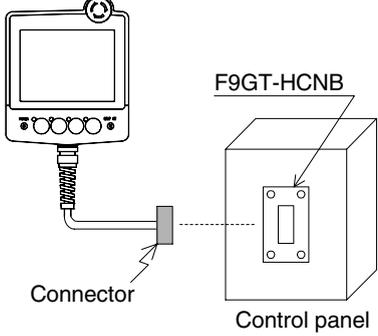
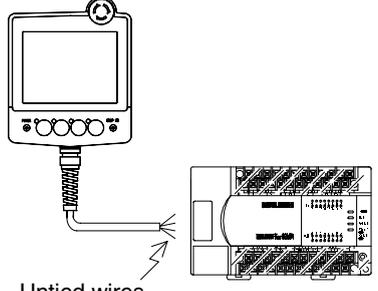
Connection method		F94□ Handy GOT	F94□ Handy GOT RH model
When the Handy GOT is attached and removed	External cable only 	✓	✓
	Using F9GT-HCNB 	✓ (F940 Handy GOT only)	-
Direct wiring		✓	✓
Reference		5.1.1	5.1.2

- 1 Introduction
- 2 Outline
- 3 Specifications
- 4 Installation and Wiring of F940GOT
- 5 Installation and Wiring of Handy GOT
- 6 Connection of Peripheral Equipment
- 7 Connection of Two or More GOT Units
- 8 Connection of MELSEC-F FX Series PLC
- 9 Connection of MELSEC-A Series PLC
- 10 Connection of MELSEC-QnA Series PLC

5.1.1 Handy GOT (Excluding RH model)

When Handy GOT is attached and removed (using only external cables)

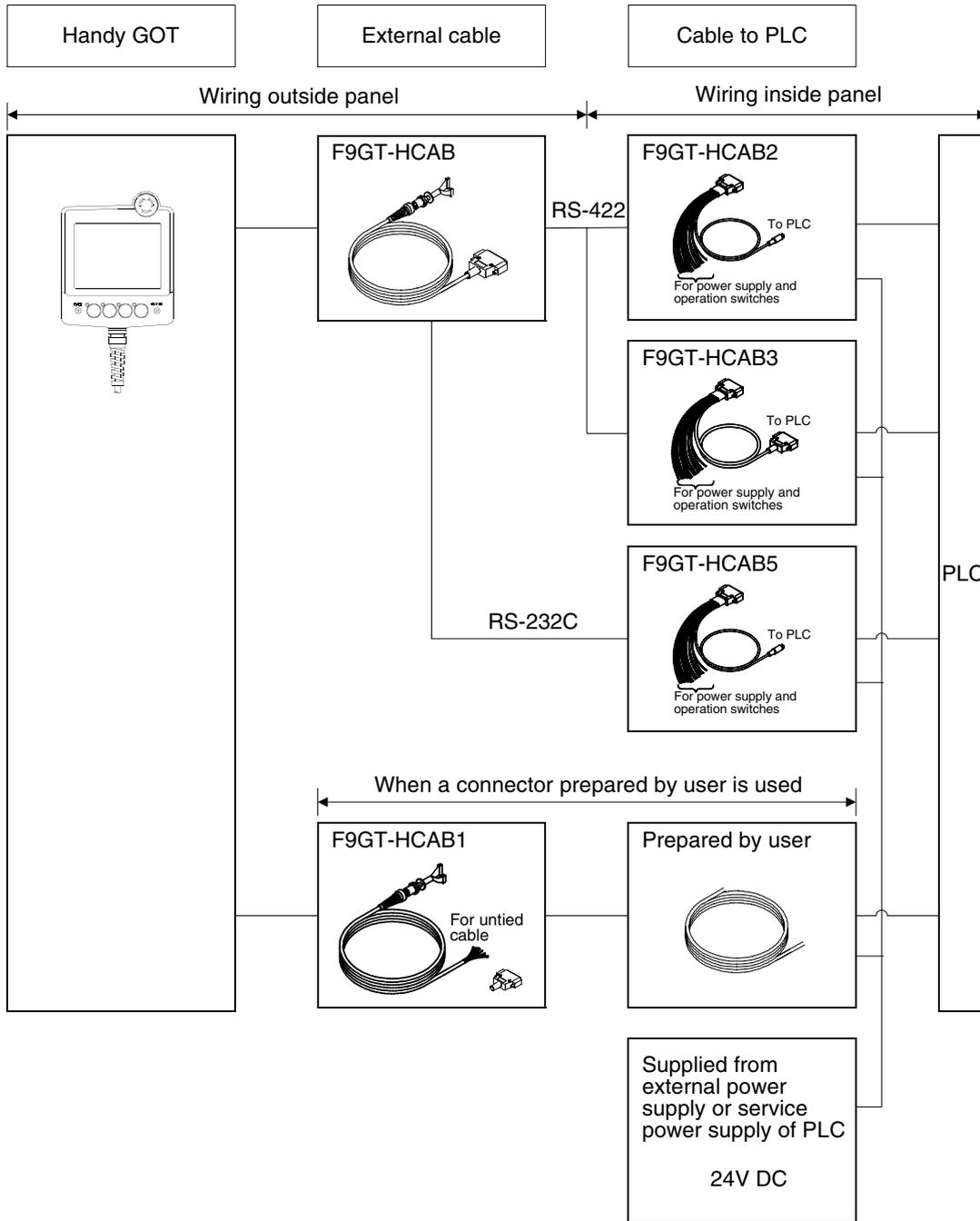

**When Handy GOT is attached and removed (using F9GT-HCNB)**

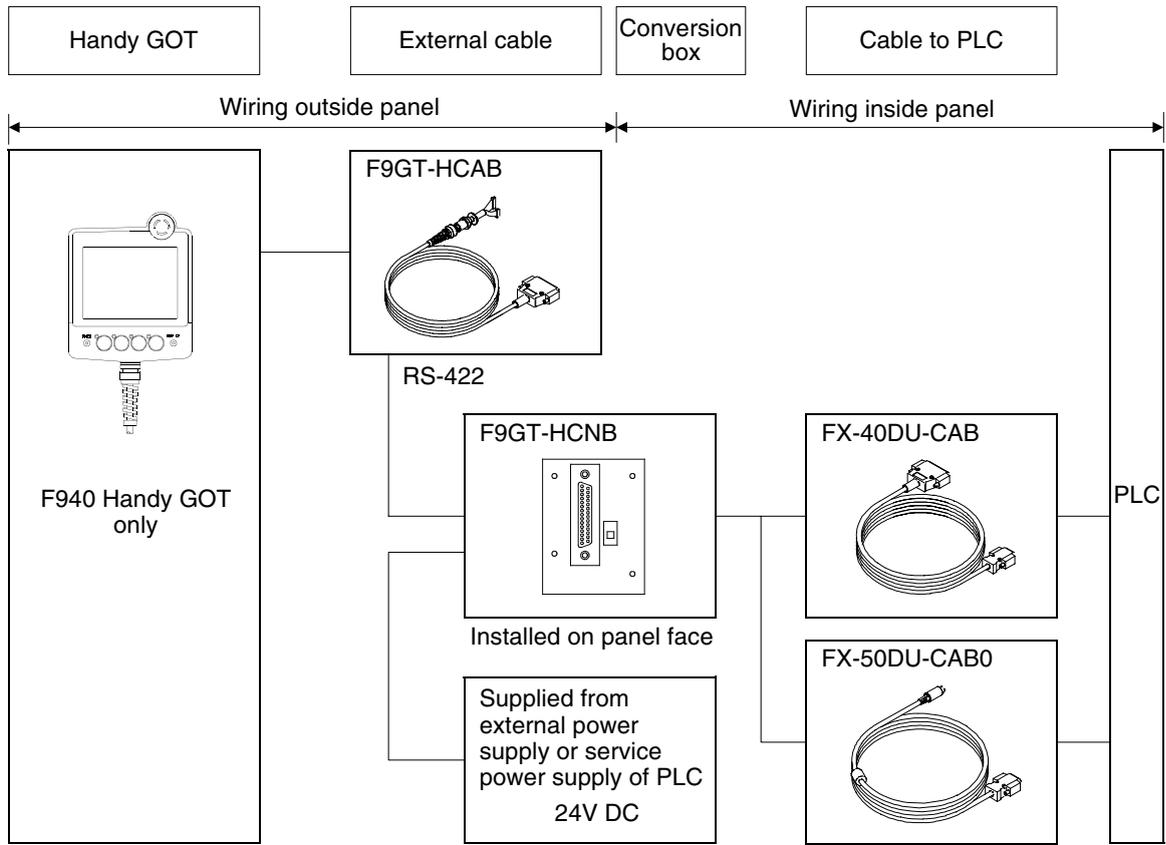

**When Handy GOT is directly wired**

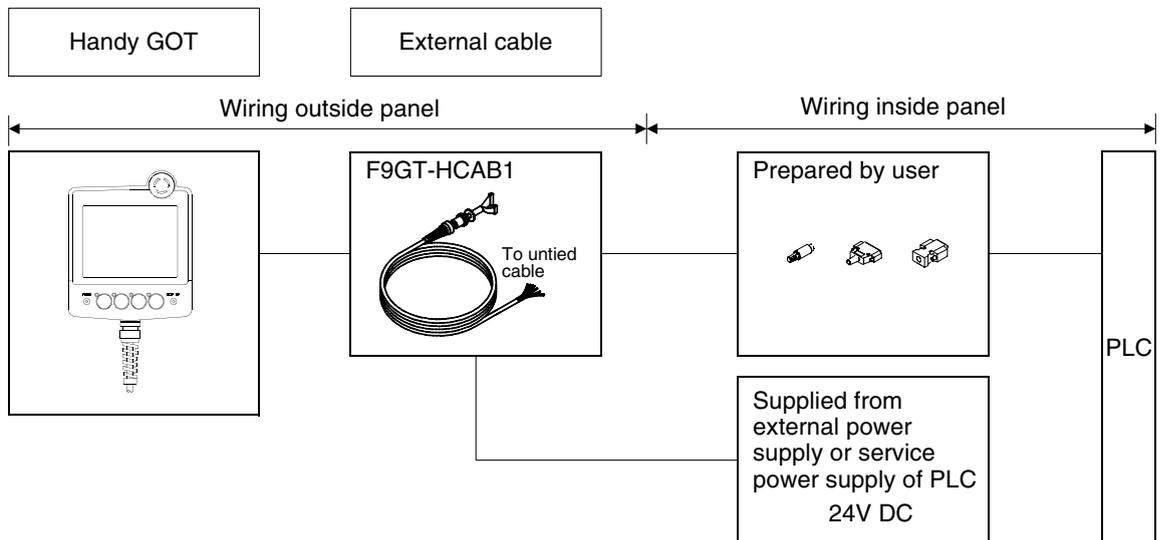

1	Introduction
2	Outline
3	Specifications
4	Installation and Wiring of F940GOT
5	Installation and Wiring of Handy GOT
6	Connection of Peripheral Equipment
7	Connection of Two or More GOT Units
8	Connection of MELSEC-FX Series PLC
9	Connection of MELSEC-A Series PLC
10	Connection of MELSEC-QnA Series PLC

5.1.2 Handy GOT (RH model)

When Handy GOT is attached and removed (using only external cables)

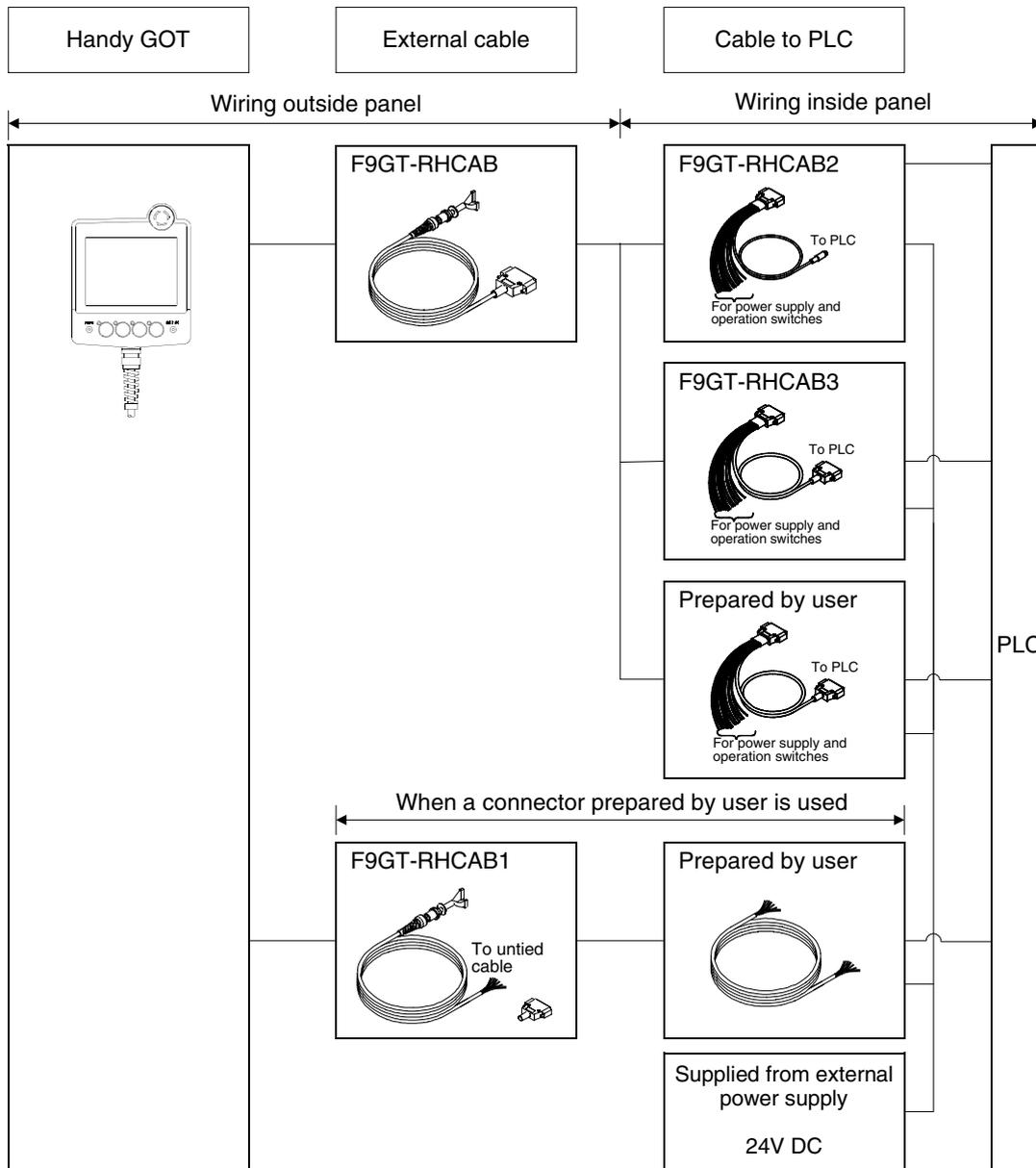



When Handy GOT is directly wired

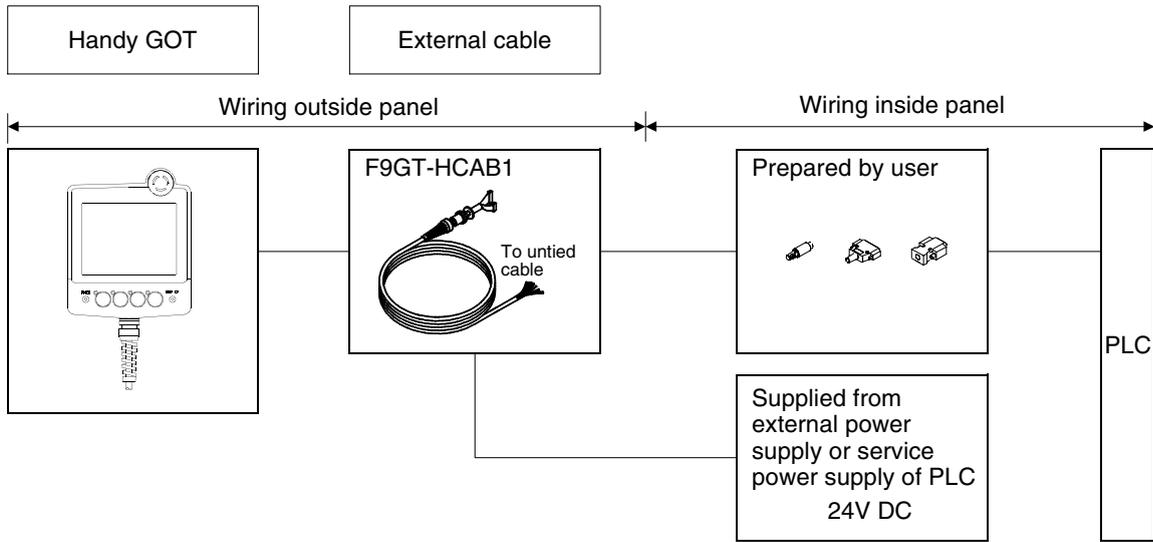

1	Introduction
2	Outline
3	Specifications
4	Installation and Wiring of F940GOT
5	Installation and Wiring of Handy GOT
6	Connection of Peripheral Equipment
7	Connection of Two or More GOT Units
8	Connection of MELSEC-F FX Series PLC
9	Connection of MELSEC-A Series PLC
10	Connection of MELSEC-QnA Series PLC

## 5.2 Name of Each Part

This section explains roughly the name and the function of each part of the Handy GOT.

### 5.2.1 Front Panel

The name and the function of each part on the front panel of the Handy GOT are shown below.

#### Handy GOT

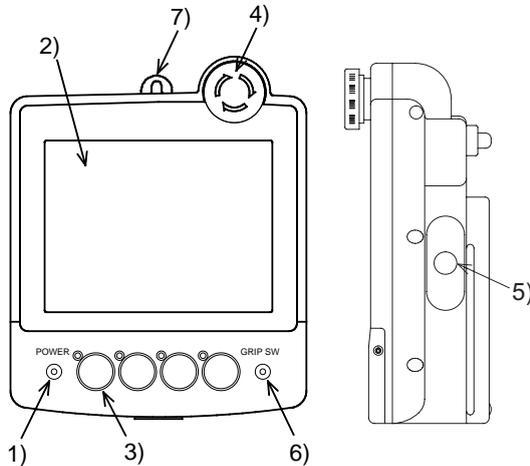

#### Handy GOT RH model

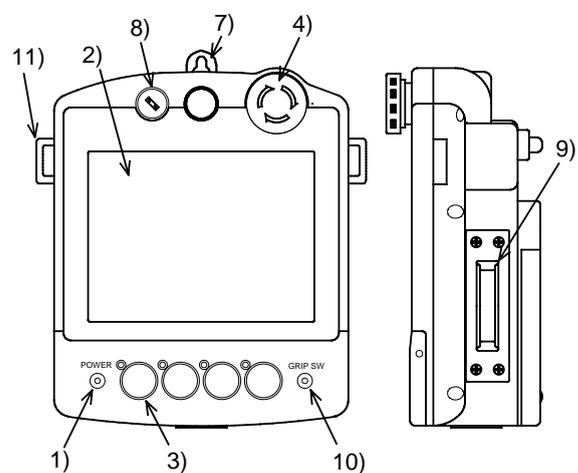

#### 1) POWER LED

Lit while the DC power is supplied to the Handy GOT.

#### 2) Touch key LCD unit

Consists of LC elements with touch keys.

There are two types, 8-color and black-and-white.

Display size: 320 × 240 dots

Effective display size: 115(4.53") W × 86(3.39") H mm

\* For the detailed functions, refer to the GOT-F900 SERIES OPERATION MANUAL.

#### 3) Operation switches (4 switches)

Direct connection to inputs in the PLC.

The name of these operation switches can be personalized using a name sheet offered as accessories. Each switch is equipped with a green LED which indicates its status. The green LED lighting command is transferred between the PLC through serial communication. The display control can be set freely using programs in the PLC.

#### 4) Emergency stop switch

Independent contact, 24V DC specification.

#### 5) Grip switch

While the grip switch is being pressed, manipulation of the touch keys on the screen is effective.

#### 6) GRIP SW LED

While the grip switch is being pressed, manipulation of the touch keys on the screen is effective.

#### 7) Metal hook for wall hanging (Holder)

Offered to mount the Handy GOT on a wall for operation or storage.

#### 8) Keylock switch

2-positioned switch. A key can be inserted or removed to lock the switch position.

#### 9) Grip switch

The 3-positioned operation switch (OFF/ON/OFF) turns ON when pressed halfway and turns OFF when pressed all the way or when released.

#### 10)Grip switch LED

LED for confirming ON/OFF status of the grip switch. The parameters for controlling the LED can be set in the screen creation software and PLC program.

#### 11)Strap holders

Loops for the strap.

#### 12)Name sheet insertion slot

Can be seen when the operation switch cover is removed from the lower portion of the Handy GOT.

When operation switch cover is removed

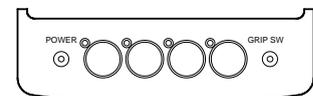
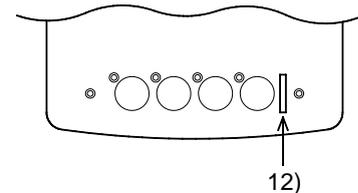

Operation switch cover

### 5.2.2 Rear Panel and Connectors

The name and the function of each part on the rear panel of the Handy GOT are shown below. When the rear cover is removed, diversified connectors can be seen.

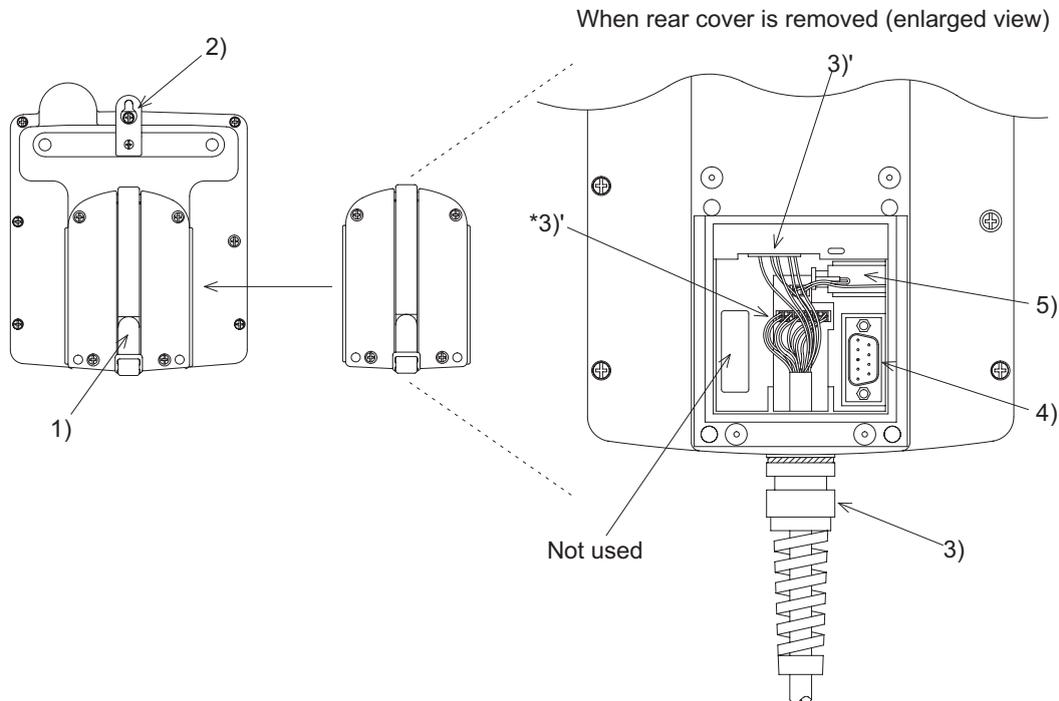

**1) Hand strap**

Helps the user to hold the Handy GOT. The length of the strap can be adjusted.

**2) Metal hook for wall hanging**

Offered to mount the Handy GOT on a wall for operation or accommodation.

**3) External cable (option)**

Offered to connects a PLC, power supply or operation switch to ports outlined in 3)'.

\* The port 3)' are provided for RS-422 or RS-232C communication depending on the product as shown in the table below.

Model name	Signal
F940GOT-SBD-H-E, F940GOT-SBD-RH-E F940GOT-LBD-H-E, F940GOT-LBD-RH-E	RS-422
F943GOT-SBD-H-E, F943GOT-SBD-RH-E F943GOT-LBD-H-E, F943GOT-LBD-RH-E	RS-232C

**4) Personal computer port (RS-232C) 9-pin D-Sub, male**

Offered to transfer the screen data created using the screen creation software or to use the two-port interface function.

**5) Battery**

FX2NC-32BL is built into back up data.

1	Introduction
2	Outline
3	Specifications
4	Installation and Wiring of F940GOT
5	Installation and Wiring of Handy GOT
6	Connection of Peripheral Equipment
7	Connection of Two or More GOT Units
8	Connection of MELSEC-F FX Series PLC
9	Connection of MELSEC-A Series PLC
10	Connection of MELSEC-QnA Series PLC

### 5.3 Outside Dimensions and Installation

This paragraph explains the outside dimensions and installation of the Handy GOT. Sufficiently understand the specifications before installing the Handy GOT.

#### 5.3.1 Outside Dimensions

F940 Handy GOT

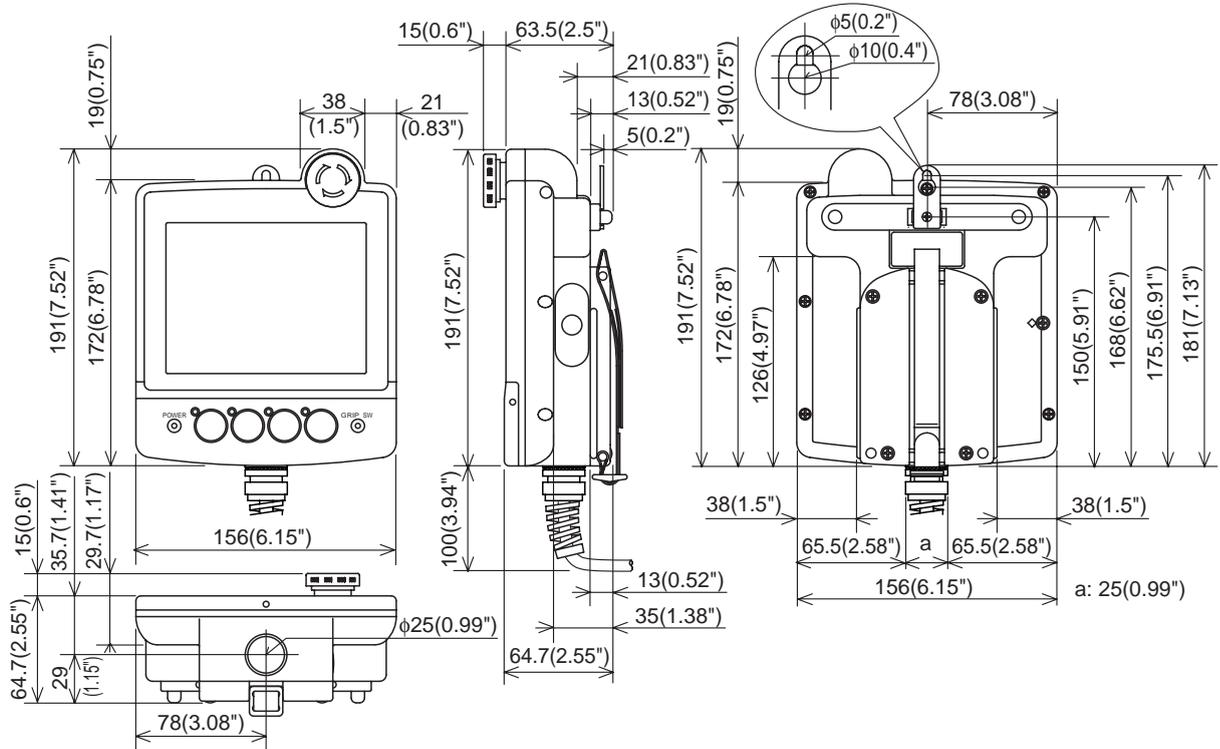

F940 Handy GOT RH model

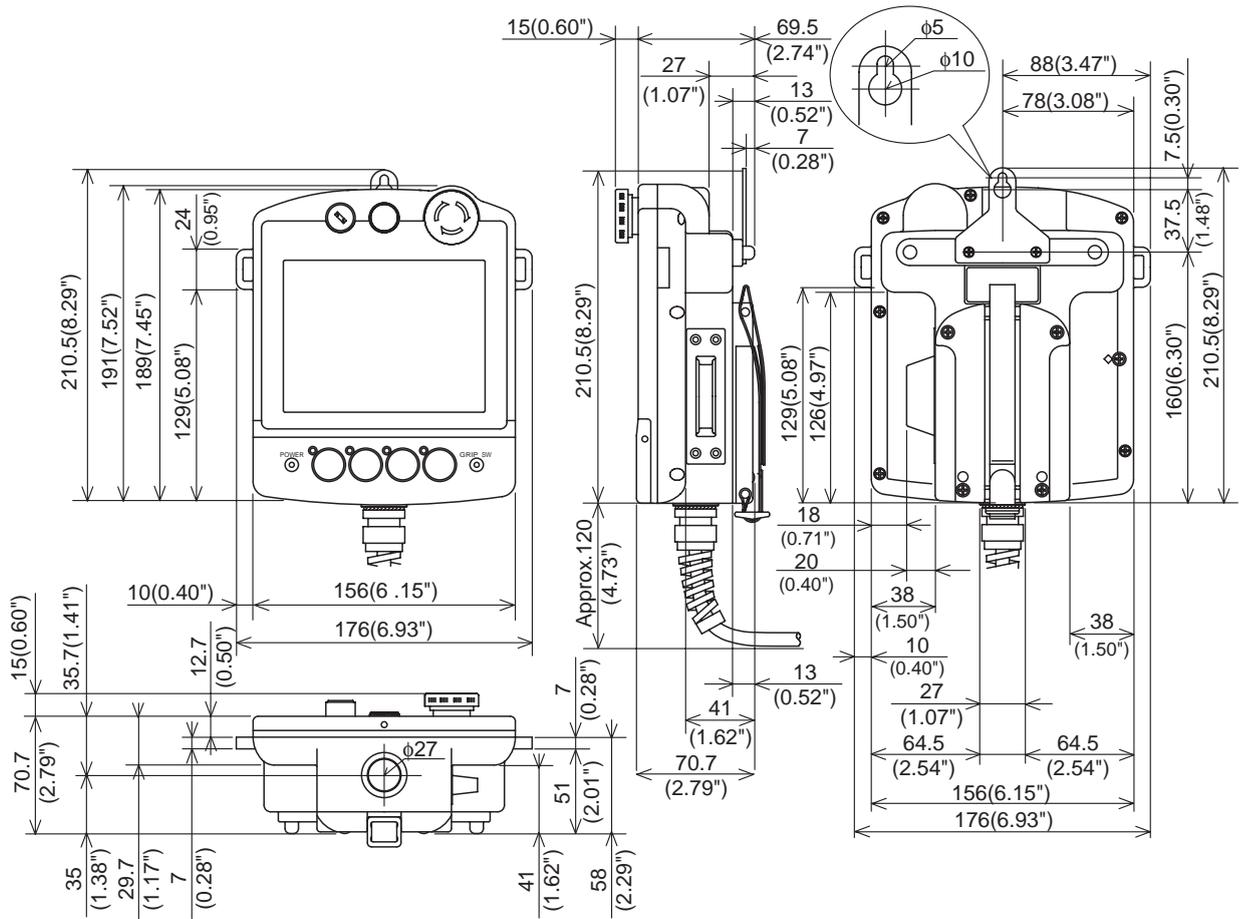

1	Introduction
2	Outline
3	Specifications
4	Installation and Wiring of F940GOT
5	Installation and Wiring of Handy GOT
6	Connection of Peripheral Equipment
7	Connection of Two or More GOT Units
8	Connection of MELSEC-F FX Series PLC
9	Connection of MELSEC-A Series PLC
10	Connection of MELSEC-QnA Series PLC

### 5.3.2 Installation

#### 1) Holding

When holding the Handy GOT for operation, place your hand through the hand strap provided on its rear face. You can adjust the length of the hand strap.

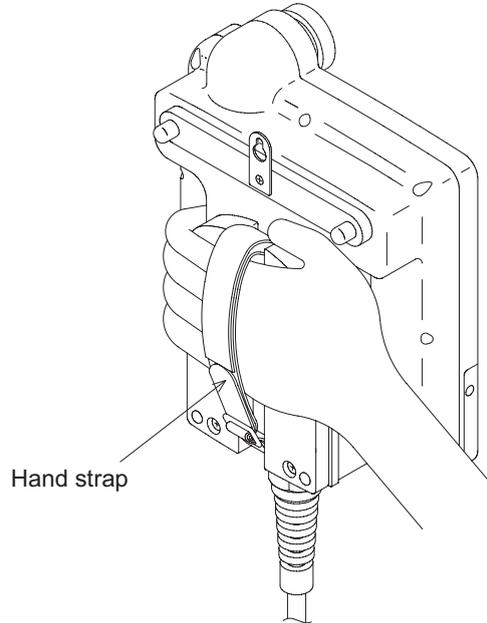

#### 2) Hanging on Wall

When operating the Handy GOT while keeping it hung on the wall, use the metal fixture for wall hanging provided on the rear face of the Handy GOT.

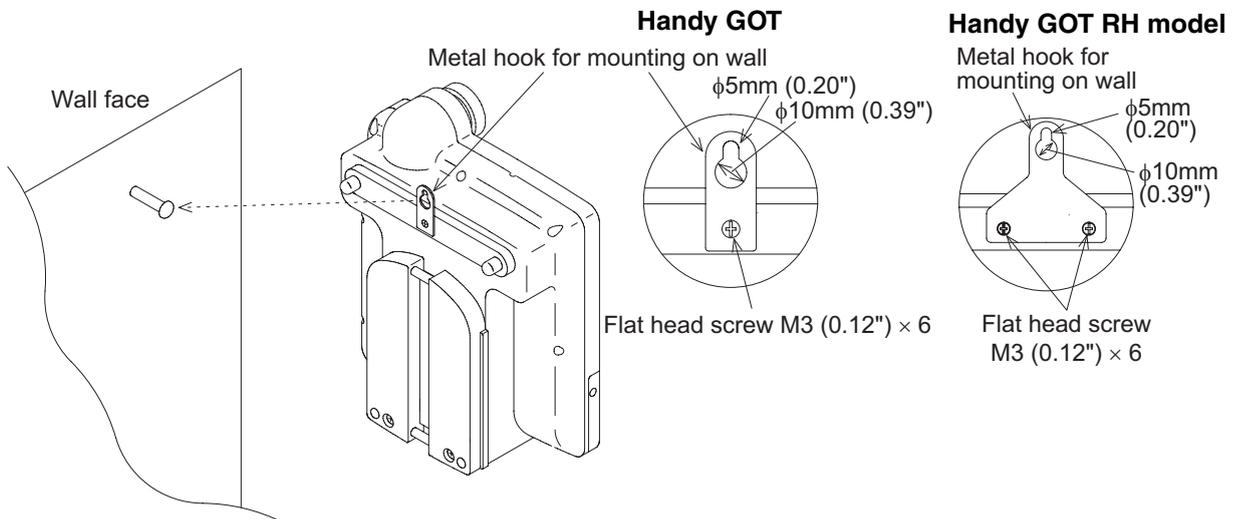

On the wall face, the weight of the main unit (approximately 0.79 kg/1.74 lbs, RH model 0.87 kg/1.91 lbs) and a load of approximately 1 ~ 3 kg (2.20 ~ 6.61 lbs) which varies depending on the communication cable length are applied. While taking this into consideration, attach a suitable metal fixture on the wall.

**3) Flat Surface Mounting**

When using the Handy GOT on a flat surface, such as a desk or shelf, keep the Handy GOT parallel to the surface so that it does not drop and, fix the communication cable to the desk.

**Outside diameter of connection cable**

Model	External cable	Outside diameter
For F940 Handy GOT model For F943 Handy GOT model	F9GT-HCAB-□□M F9GT-HCAB1-□□M	8.2mm (0.32")
For F940 Handy GOT RH model For F943 Handy GOT RH model	F9GT-RHCAB-□□M F9GT-RHCAB1-□□M	12.2mm (0.48")

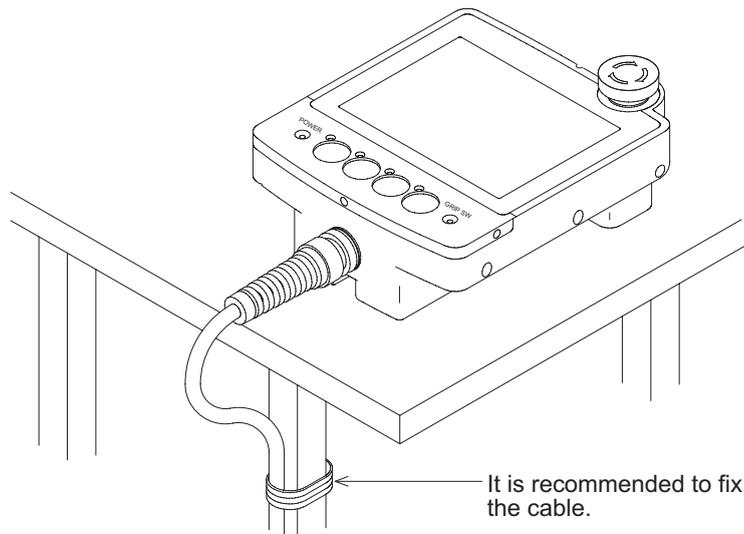

**4) Installation of Strap for Drop Prevention (RH model only)**

A strap to help prevent accidental drops or for shoulder/hand carry (prepared by the user) can be attached to the loops.

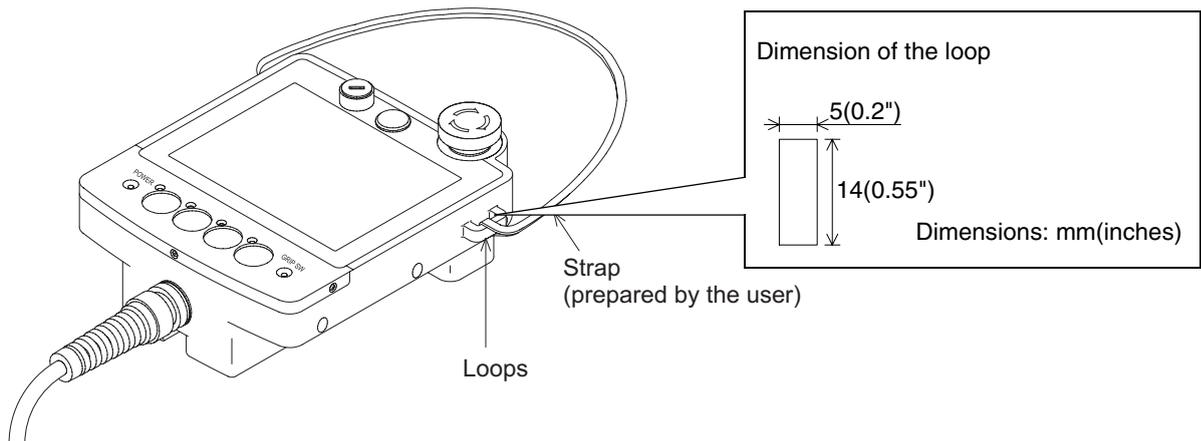

1	Introduction
2	Outline
3	Specifications
4	Installation and Wiring of F940GOT
5	Installation and Wiring of Handy GOT
6	Connection of Peripheral Equipment
7	Connection of Two or More GOT Units
8	Connection of MELSEC-F FX Series PLC
9	Connection of MELSEC-A Series PLC
10	Connection of MELSEC-QnA Series PLC

## 5.4 Selection and Installation of External Cable

A cable combined for the PLC varies among the F940/F930 Handy GOT RH model and other models. Select a suitable cable in reference to the figures below.

### 5.4.1 Handy GOT (Excluding RH model)

#### 1) F940 Handy GOT

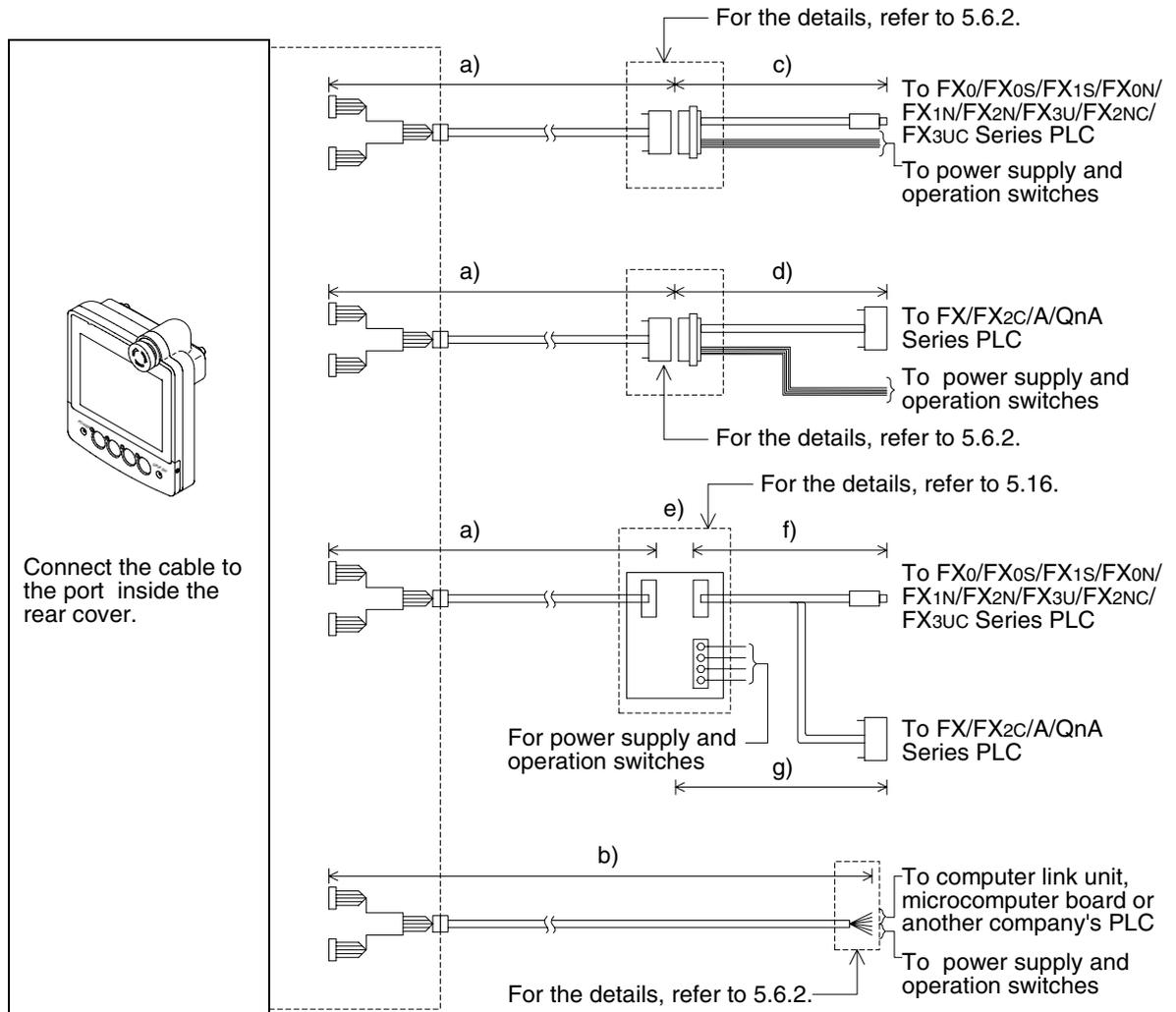

In connection through RS-422, the connection distance between the Handy GOT and the PLC should be 11.5 m (37' 9") maximum.



Name	Model name	Remarks
a) External cable	F9GT-HCAB-3M(3m, 9' 10") F9GT-HCAB-10M(10m, 32' 10")	One side: 25-pin D-Sub Cable outside diameter: 8.2mm(0.32")
b) External cable	F9GT-HCAB1-3M(3m, 9' 10") F9GT-HCAB1-10M(10m, 32' 10")	One side: Untied 20-core wires Cable outside diameter: 8.2mm(0.32")
c) Relay cable for PLC connection	F9GT-HCAB2-150(1.5m, 4' 11")	PLC side: 8-pin MINI DIN Refer to 5.5.3.
d) Relay cable for PLC connection	F9GT-HCAB3-150(1.5m, 4' 11")	PLC side: 25-pin D-Sub Refer to 5.5.3.
e) Connector conversion box	F9GT-HCNB	Refer to 5.16.
f) PLC connection cable	FX-50DU-CAB0(3m, 9' 10") FX-50DU-CAB0-1M(1m, 3' 3")	For connecting FX Series CPU PLC side: 8-pin MINI DIN
g) PLC connection cable	FX-40DU-CAB(3m, 9' 10")	For connecting FX/A/QnA Series CPU PLC side: 25-pin D-Sub

2) F943 Handy GOT

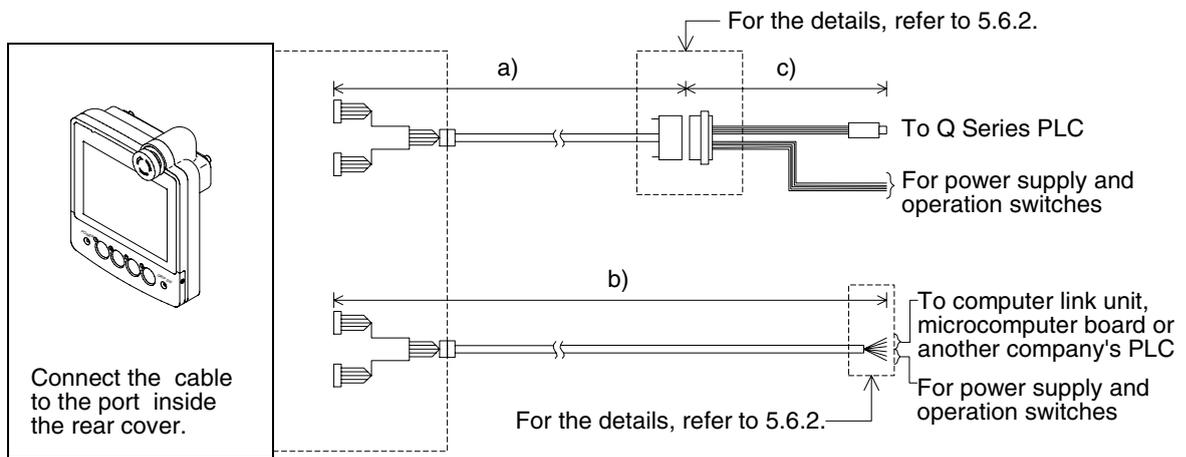

When connecting via RS-232C ports, make sure that the distance between the Handy GOT and PLC is 6m (19' 8") or less.

Name	Model name	Remarks
a) External cable	F9GT-HCAB-3M(3m, 9' 10")	One side: 25-pin D-Sub Cable outside diameter: 8.2mm(0.32")
b) External cable	F9GT-HCAB1-3M(3m, 9' 10")	One side: Untied 20-core wires Cable outside diameter: 8.2mm(0.32")
c) Relay cable for PLC connection	F9GT-HCAB5-150(1.5m, 4' 11")	For connecting Q Series CPU PLC side: 6-pin MINI DIN

1 Introduction

2 Outline

3 Specifications

4 Installation and Wiring of F940GOT

5 Installation and Wiring of Handy GOT

6 Connection of Peripheral Equipment

7 Connection of Two or More GOT Units

8 Connection of MELSEC-FX Series PLC

9 Connection of MELSEC-A Series PLC

10 Connection of MELSEC-QnA Series PLC

5.4.2 Wiring between Handy GOT (RH model) operation switches and connected equipment

1) F940 Handy GOT

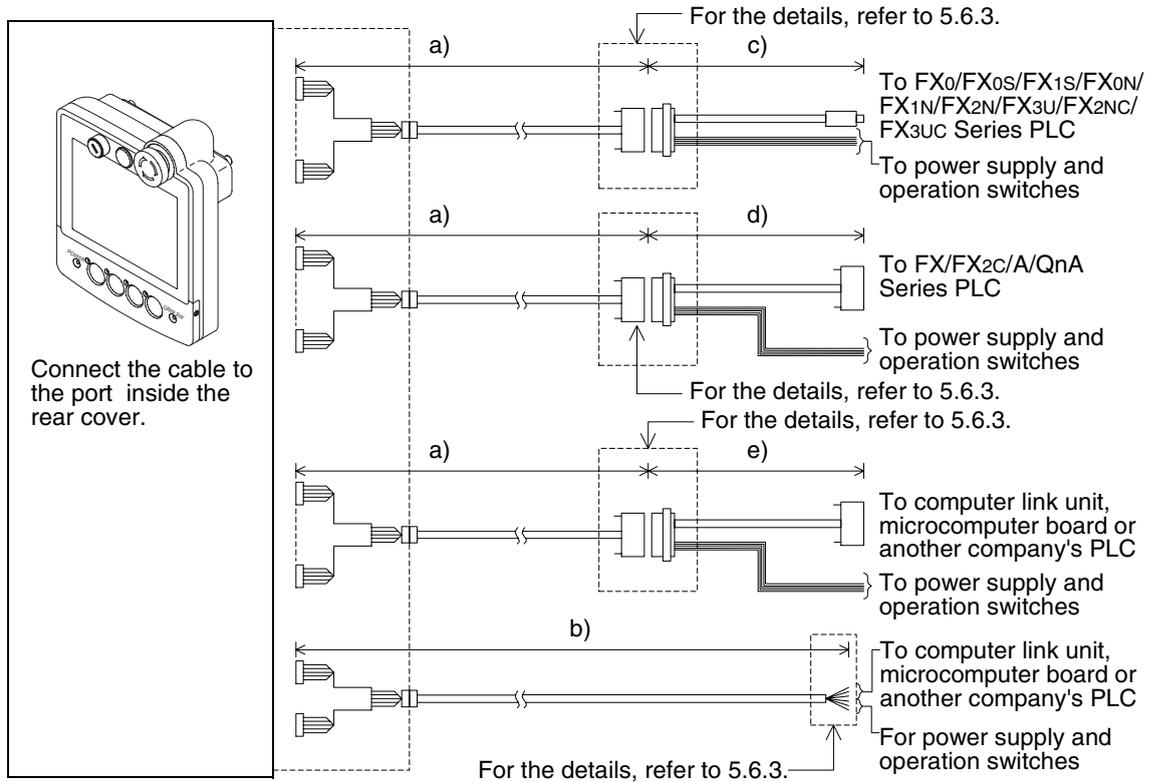

When connecting via RS-232C ports, make sure that the distance between the Handy GOT and PLC is 11.5m (37' 9") or less.

Name	Model name	Remarks
a) External cable	F9GT-RHCAB-3M(3m, 9' 10") F9GT-RHCAB-6M(6m, 19' 8") F9GT-RHCAB-10M(10m, 32' 10")	One side: 37-pin D-Sub Cable outside diameter: 12.2mm(0.48")
b) External cable	F9GT-RHCAB1-3M(3m, 9' 10") F9GT-RHCAB1-10M(10m, 32' 10")	One side: Untied 32-core wires Cable outside diameter: 12.2mm(0.48")
c) Relay cable for PLC connection	F9GT-RHCAB2-150(1.5m, 4' 11")	For connecting FX Series CPU PLC side: 8-pin MINI DIN
d) Relay cable for PLC connection	F9GT-RHCAB3-150(1.5m, 4' 11")	For connecting FX/A/QnA Series CPU PLC side: 25-pin D-Sub
e) Relay cable for PLC connection	Prepared by user	

• F9GT-RHCAB-□M

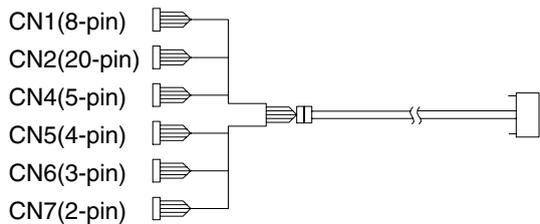

- CN1: For power supply
- CN2: For communication
- CN4: For grip switch
- CN5: For emergency stop switch
- CN6: For keylock switch
- CN7: Not to be wired

• F9GT-RHCAB1-□M

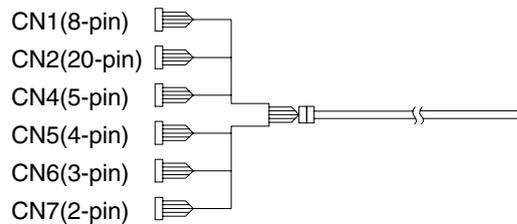

- CN1: For power supply
- CN2: For communication
- CN4: For grip switch
- CN5: For emergency stop switch
- CN6: For keylock switch
- CN7: Not to be wired

2) F943 Handy GOT

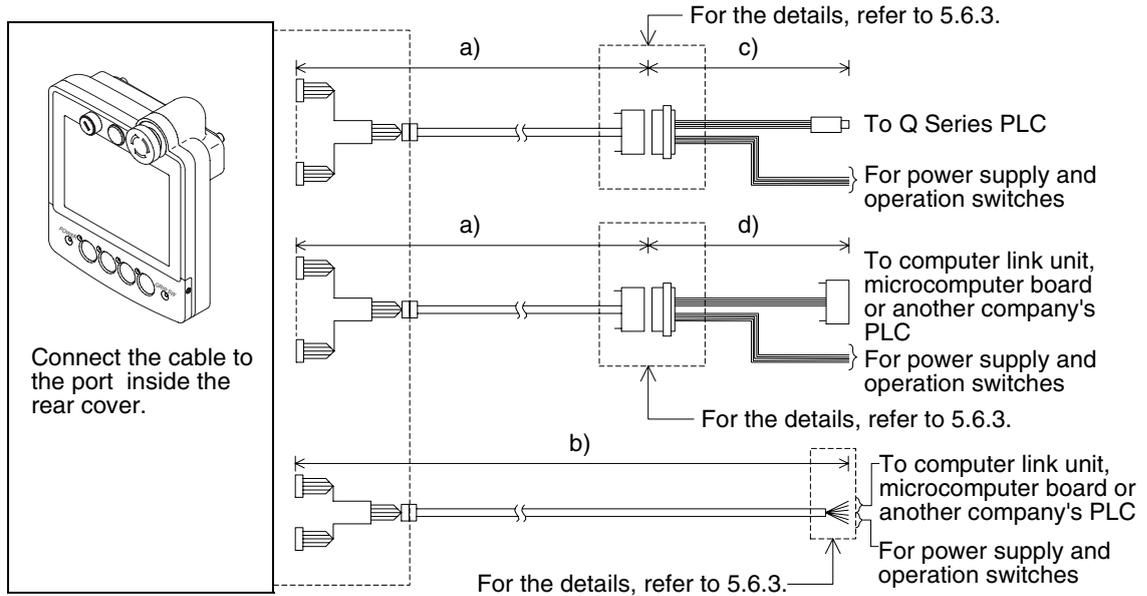

When connecting via RS-232C ports, make sure that the distance between the Handy GOT and PLC is 6m (19' 8") or less.

Name	Model name	Remarks
a) External cable	F9GT-RHCAB-3M(3m, 9' 10")	One side: 25-pin D-Sub Cable outside diameter: 12.2mm(0.48")
b) External cable	F9GT-RHCAB1-3M(3m, 9' 10") F9GT-RHCAB1-10M(10m, 32' 10")	One side: Untied 32-core wires Cable outside diameter: 12.2mm(0.48")
c) Relay cable for PLC connection	F9GT-RHCAB5-150(1.5m, 4' 11")	For connecting Q CPU PLC side: 6-pin MINI DIN
d) Relay cable for PLC connection	Prepared by user	

• F9GT-RHCAB-□M

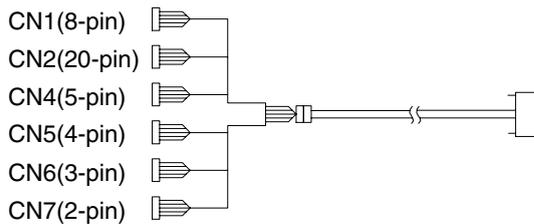

- CN1: For power supply
- CN2: For communication
- CN4: For grip switch
- CN5: For emergency stop switch
- CN6: For keylock switch
- CN7: Not to be wired

• F9GT-RHCAB1-□M

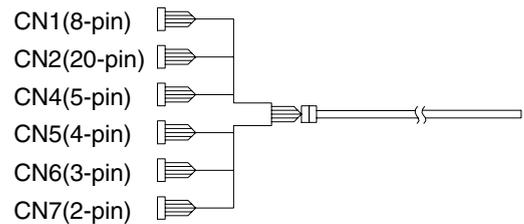

- CN1: For power supply
- CN2: For communication
- CN4: For grip switch
- CN5: For emergency stop switch
- CN6: For keylock switch
- CN7: Not to be wired

1	Introduction
2	Outline
3	Specifications
4	Installation and Wiring of F940GOT
5	Installation and Wiring of Handy GOT
6	Connection of Peripheral Equipment
7	Connection of Two or More GOT Units
8	Connection of MELSEC-FX Series PLC
9	Connection of MELSEC-A Series PLC
10	Connection of MELSEC-QnA Series PLC

**Note:**

The connection distance between the Handy GOT and the PLC ("a + c)" or "b") should be within 6m (19' 8").

**Caution for CE EMC:**

For compliance to CE EMC regulations it is necessary to add a ferrite filter on the external cable for F943GOT-SBD-H-E or F943GOT-LBD-H-E.

The filter should be attached as shown right with the filter surrounding the external cable.

The recommended ferrite filter is the TDK ZCAT2035-0930A-BK or equivalent.

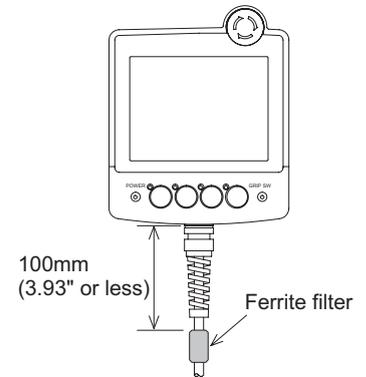

### 5.4.3 Installation of External Cable

This section explains the procedure to install an optional external cable to the Handy GOT.

#### 1) Remove rear cover

Rear face of Handy GOT

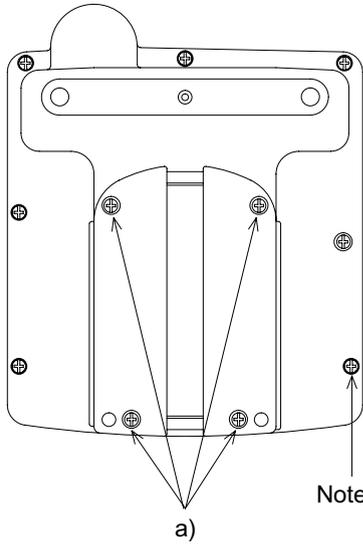

Remove four mounting screws "a", and open the rear cover.  
Installation screw M3(0.12") × 8

**Note:**

Never remove any screw (among seven screws located around the rear face of the Handy GOT) other than the mounting screws "a". If such a screw is removed, the waterproof ability may deteriorate or failure may occur.

When rear cover is open  
Handy GOT

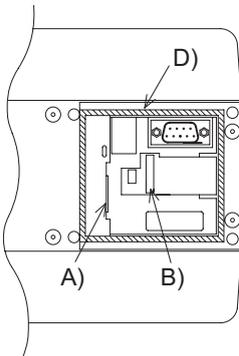

- A) Power supply connector (8 pins)
- B) Connector for communication and operation switches (20 pins)
- C) Installation hole
- D) Packing

Handy GOT RH model

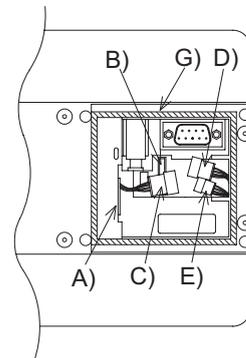

- A) Power supply connector (CN1: 8 pins)
- B) Connector for communication and operation switches (CN2: 20 pins)
- C) Connector for grip switch (CN4: 5 pins)
- D) Connector for emergency stop (CN5: 4 pins)
- E) Installation hole (CN6: 3 pins)
- F) Installation hole
- G) Packing

1	Introduction
2	Outline
3	Specifications
4	Installation and Wiring of F940GOT
5	Installation and Wiring of Handy GOT
6	Connection of Peripheral Equipment
7	Connection of Two or More GOT Units
8	Connection of MELSEC-F FX Series PLC
9	Connection of MELSEC-A Series PLC
10	Connection of MELSEC-QnA Series PLC

**2) Connect an external cable**

- a) Insert an external cable into the installation hole C) of the main unit, and connect it to the ports A) and B).  
For F94□ Handy GOT RH model, connect it to the ports A), B), C), D), and E).

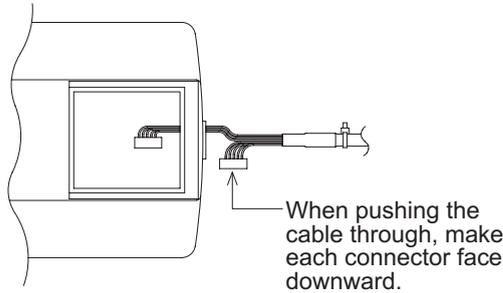

- b) Tighten the hexagon nut.

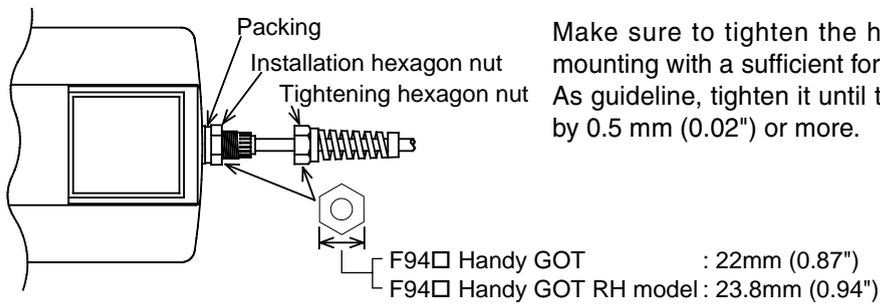

Make sure to tighten the hexagon nut for cable mounting with a sufficient force to avoid looseness. As guideline, tighten it until the packing is crushed by 0.5 mm (0.02") or more.

- c) Pull lightly on the cable until it naturally stops.

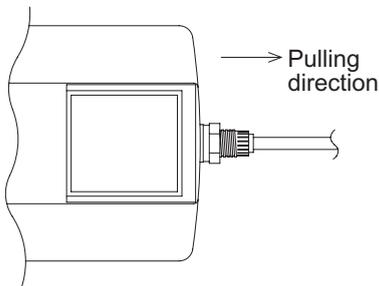

- d) Securely tighten the hexagon nut for cable sewing so that the cable will not come out or the waterproof ability will not be deteriorated.

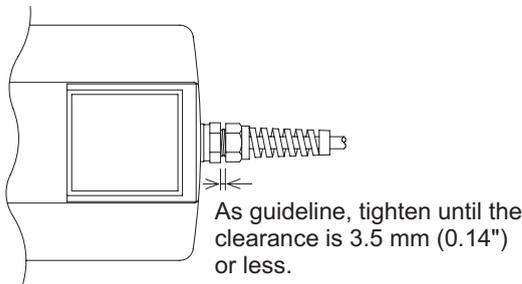

**3) Attach rear cover**

- a) Before closing the rear cover, make sure that the packing D) has not come off.
- b) Attach the rear cover.
- c) Tighten four mounting screws.  
Make sure the tightening torque is 0.49 to 0.68 N•m.

## 5.5 Processing Panel Face of Control Box or Cabinet

This section explains the panel processing procedure required when a connector is provided and the Handy GOT is attached or removed after a connector is provided to it.

### 5.5.1 Selection of relay cable

#### 1) Using F940 Handy GOT

a) Installing a connector on the panel of control box or cabinet.

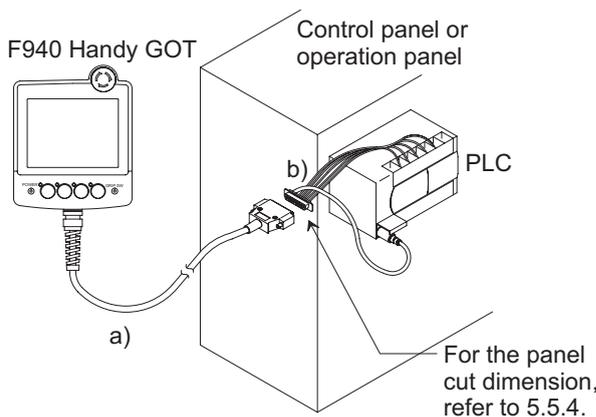

a) External cable

(with 25-pin D-Sub, male connector)  
Other than RH model

F9GT-HCAB-3M(3m, 9' 10")

F9GT-HCAB-10M(10m, 32' 10")

RH model

F9GT-RHCAB-3M(3m, 9' 10")

F9GT-RHCAB-6M(6m, 19' 8")

F9GT-RHCAB-10M(10m, 32' 10")

b) Relay cable for connection to PLC

(Refer to 5.4.2.)

25-pin D-Sub or 8-pin MINI DIN connector is offered to connect to FX CPU. Choose a proper cable between the following.

For FX CPU (FX0/FX0s/FX1s/FX0N/FX1N/  
FX2N/FX3U/FX2NC/FX3UC)

Other than RH model

F9GT-HCAB2-150(1.5m, 4' 11")

RH model

F9GT-RHCAB2-150(1.5m, 4' 11")

For A/QnA/FX CPU (FX/FX2c)

Other than RH model

F9GT-HCAB3-150(1.5m, 4' 11")

RH model

F9GT-RHCAB3-150(1.5m, 4' 11")

Any relay cable other than the above should be prepared by the user.

b) Installing the F9GT-HCAB conversion box on the panel (RH model cannot be connected.)

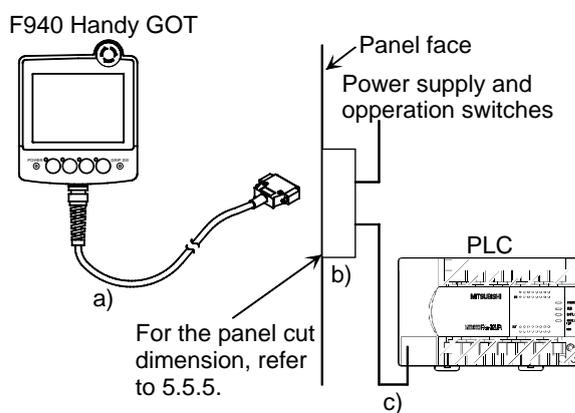

a) External cable

(with 25-pin D-Sub pin connector)

F9GT-HCAB-3M(3m, 9' 10")

F9GT-HCAB-10M(10m, 32' 10")

b) F9GT-HCNB conversion box

c) Communication cable for connection to PLC  
25-pin D-Sub or 8-pin MINI DIN connector is offered to connect to FX CPU.

For FX CPU (FX0/FX0s/FX1s/FX0N/FX1N/  
FX2N/FX3U/FX2NC/FX3UC)

FX-50DU-CAB0(3m, 9' 10")

FX-50DU-CAB0-1M(1m, 3' 3")

For A/QnA/FX CPU (FX/FX2c)

FX-40DU-CAB(3m, 9' 10")

## 2) Using F943 Handy GOT

- a) Installing a connection on the panel of control box or cabinet

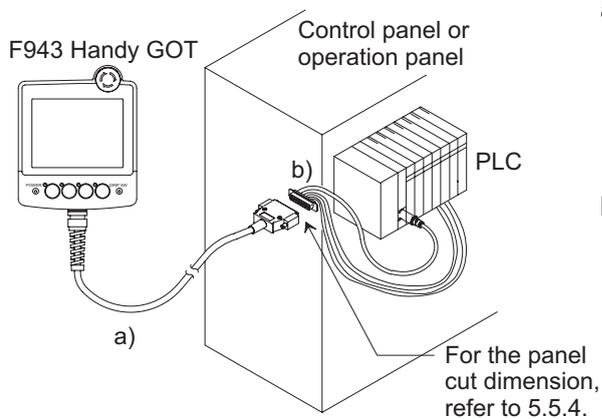

- a) External cable  
(with 25-pin D-Sub, male connector)  
Other than RH model  
F9GT-HCAB-3M(3m, 9' 10")  
RH model  
F9GT-RHCAB-3M(3m, 9' 10")
- b) Relay cable for connection to Q Series PLC  
Other than RH model  
F9GT-HCAB5-150(1.5m, 4' 11")  
RH model  
F9GT-RHCAB5-150(1.5m, 4' 11")  
A relay cable for any series other than the Q Series should be prepared by the user.

F9GT-HCAB1-□□M external cable untied should be used when the user chooses a specific connector for the F943 Handy GOT (excluding RH model) according to the specifications of equipment.

### 5.5.2 Cautions on preparing cables

When preparing the cables, use the wire size of  $0.08\text{mm}^2$  or more (AWG28 or more) for communication,  $0.3\text{mm}^2$  or more (AWG22 or more) for the power supply, operation switch, and emergency stop switch. Do not use a twisted pair cable for the power supply wire and the communication wire.



### 5.5.3 Appearance shape of Relay Cable

The panel cut dimension on the panel face is as shown in Section 5.5.4.

#### Handy GOT (Excluding RH model)

##### 1) F9GT-HCAB2-150 relay cable for FX Series

(FX0/FX0S/FX1S/FX0N/FX1N/FX2N/FX3U/FX2NC/FX3UC, FX2N-10GM, FX2N-20GM)

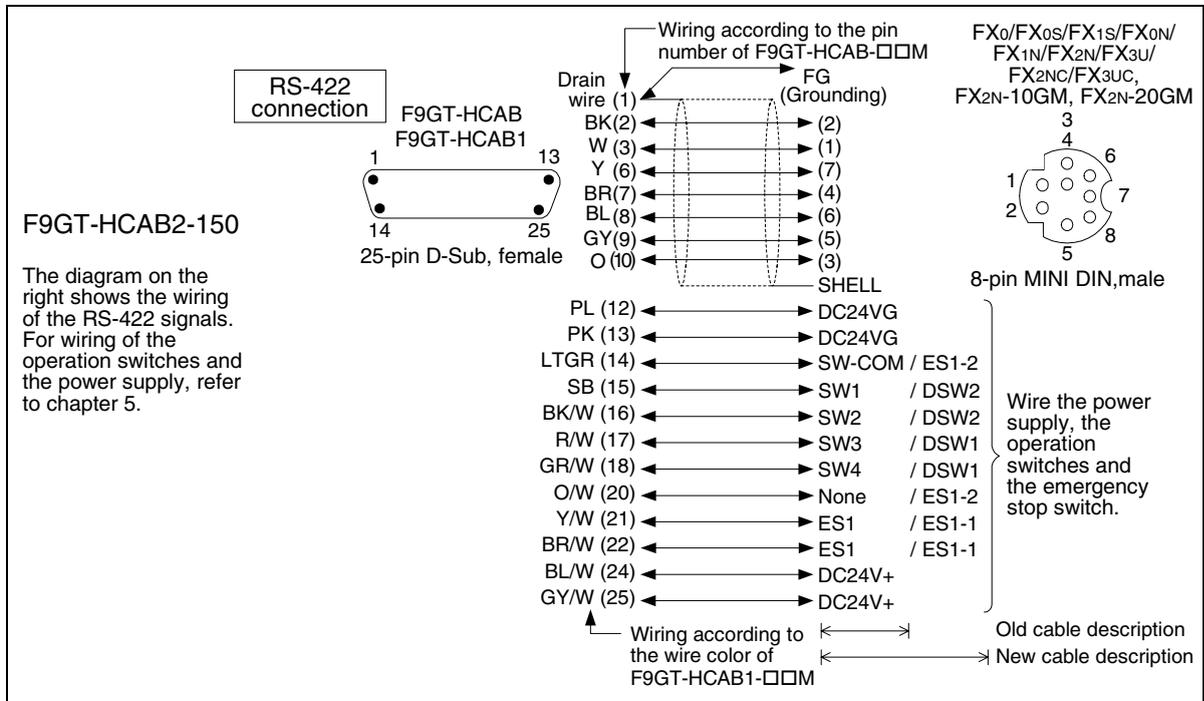
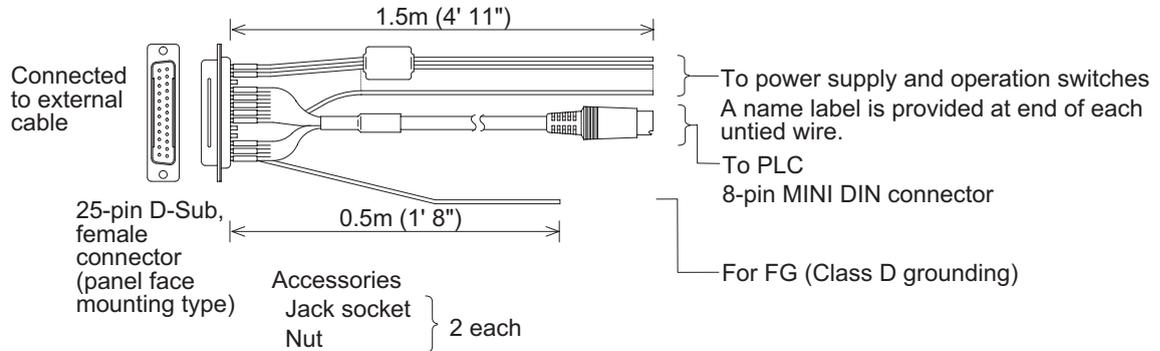

1	Introduction
2	Outline
3	Specifications
4	Installation and Wiring of F940GOT
5	Installation and Wiring of Handy GOT
6	Connection of Peripheral Equipment
7	Connection of Two or More GOT Units
8	Connection of MELSEC-F FX Series PLC
9	Connection of MELSEC-A Series PLC
10	Connection of MELSEC-QnA Series PLC

2) F9GT-HCAB3-150 relay cable for FX (FX1/FX2/FX2c), A, QnA Series PLC

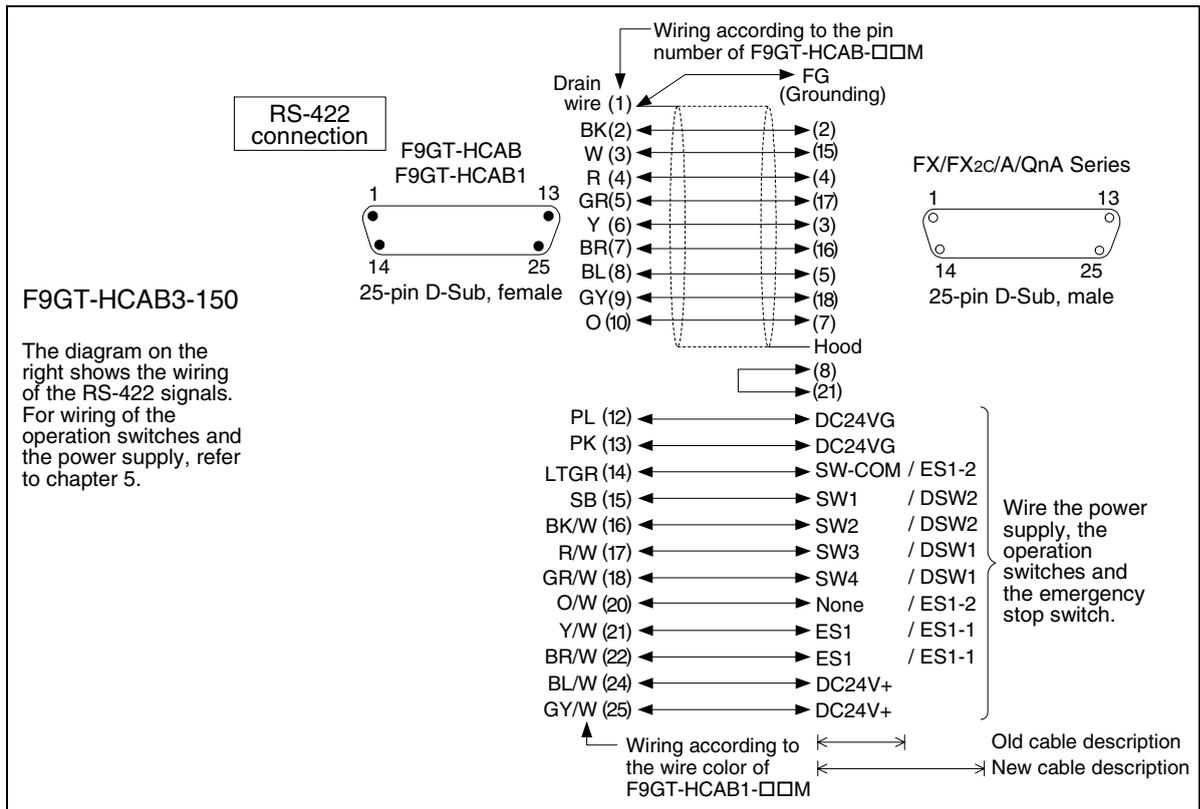
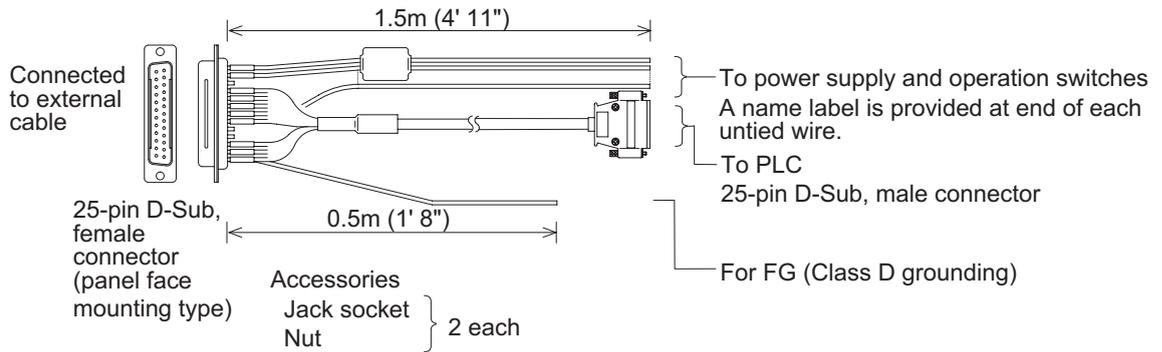

3) F9GT-HCAB5-150 relay cable for Q Series PLC

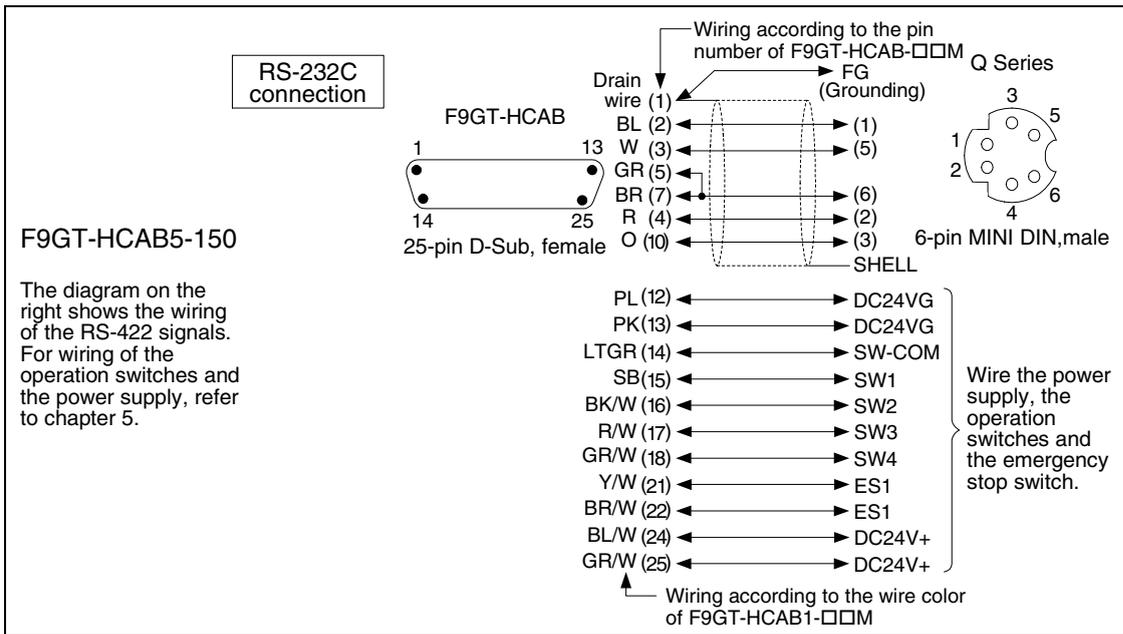
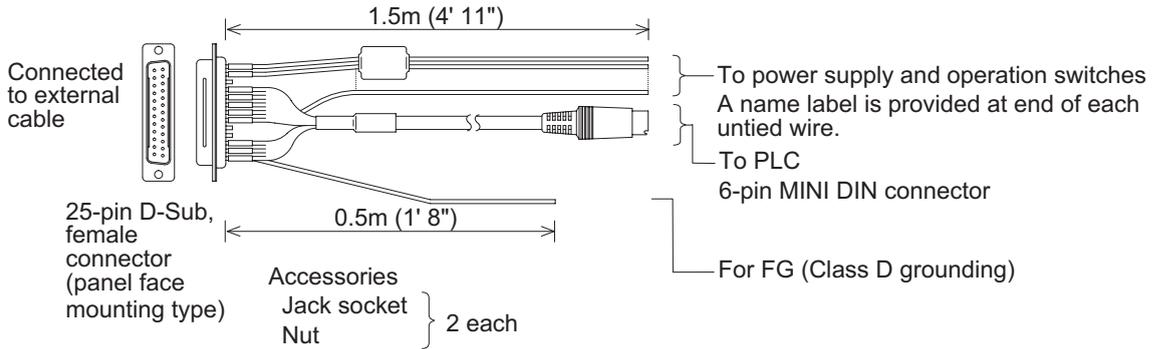

1	Introduction
2	Outline
3	Specifications
4	Installation and Wiring of F940GOT
5	Installation and Wiring of Handy GOT
6	Connection of Peripheral Equipment
7	Connection of Two or More GOT Units
8	Connection of MELSEC-F FX Series PLC
9	Connection of MELSEC-A Series PLC
10	Connection of MELSEC-QnA Series PLC

Handy GOT (RH model)

1) F9GT-RHCAB2-150 relay cable for FX Series

(FX0/FX0S/FX1S/FX0N/FX1N/FX2N/FX3U/FX2NC/FX3UC, FX2N-10GM, FX2N-20GM)

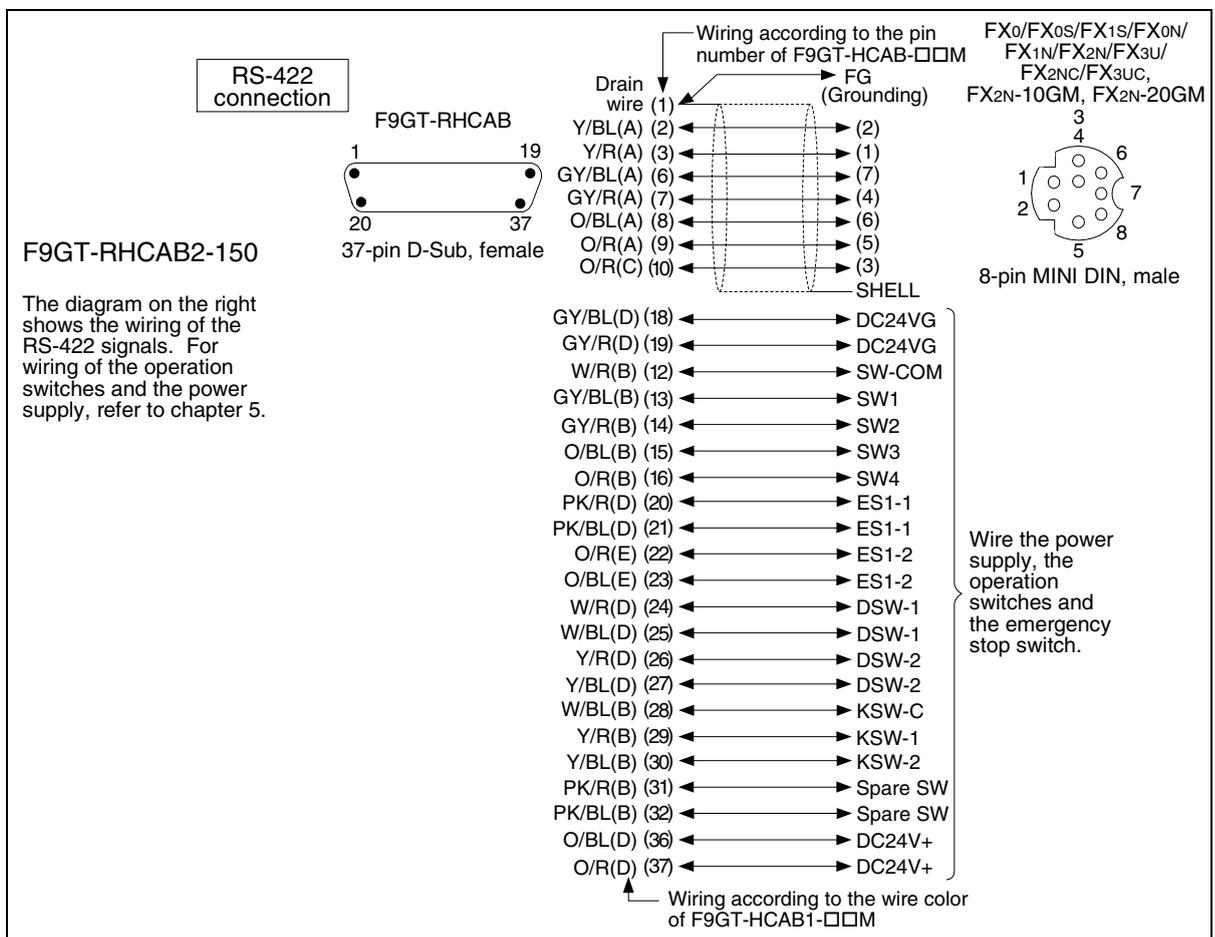
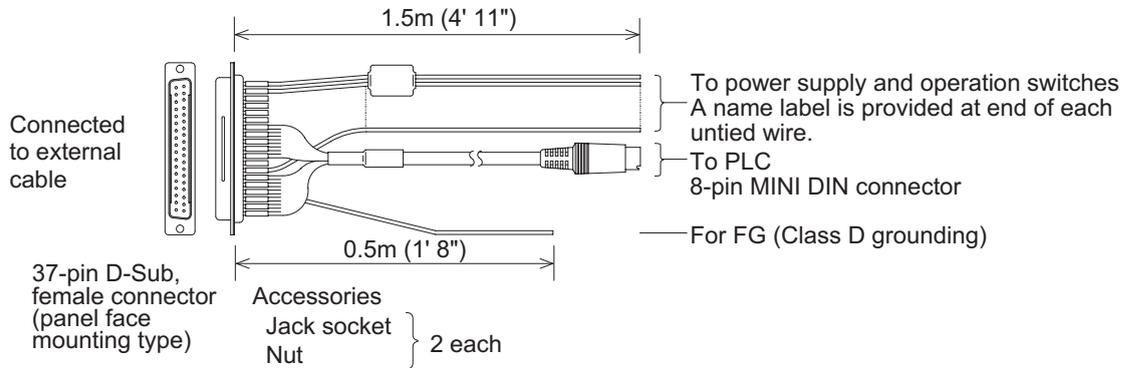

For the wire color, refer to Section 5.6.3.

2) F9GT-RHCAB3-150 relay cable for FX (FX1/FX2/FX2c), A, QnA Series PLC

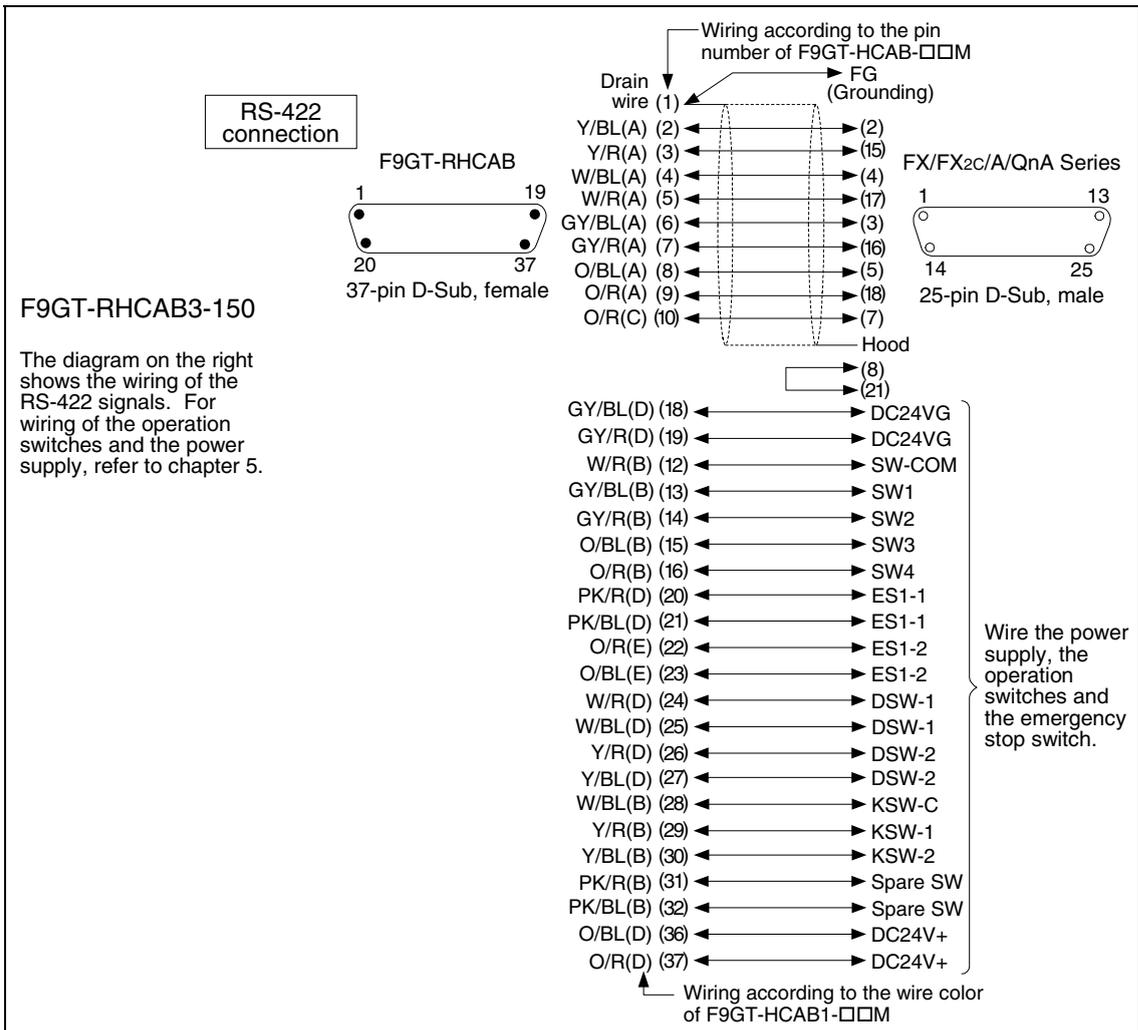
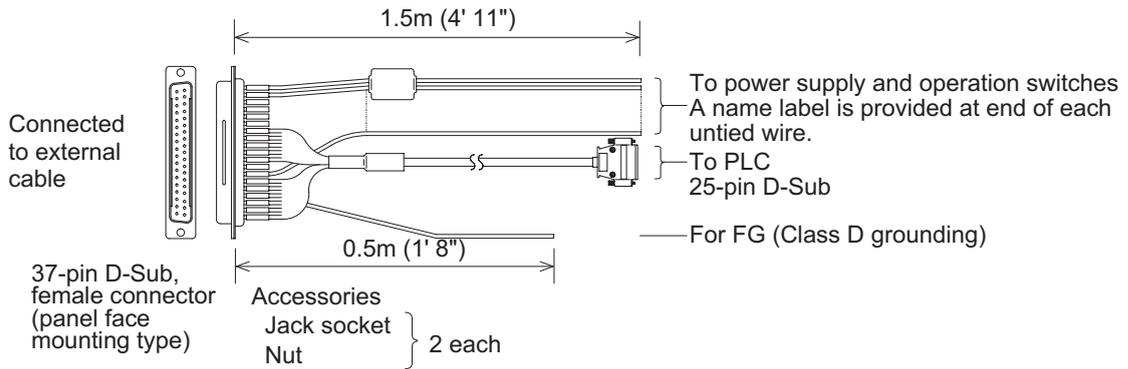

1 Introduction

2 Outline

3 Specifications

4 Installation and Wiring of F940GOT

5 Installation and Wiring of Handy GOT

6 Connection of Peripheral Equipment

7 Connection of Two or More GOT Units

8 Connection of MELSEC-FX Series PLC

9 Connection of MELSEC-A Series PLC

10 Connection of MELSEC-QnA Series PLC

3) F9GT-RHCAB5-150 relay cable for Q Series PLC

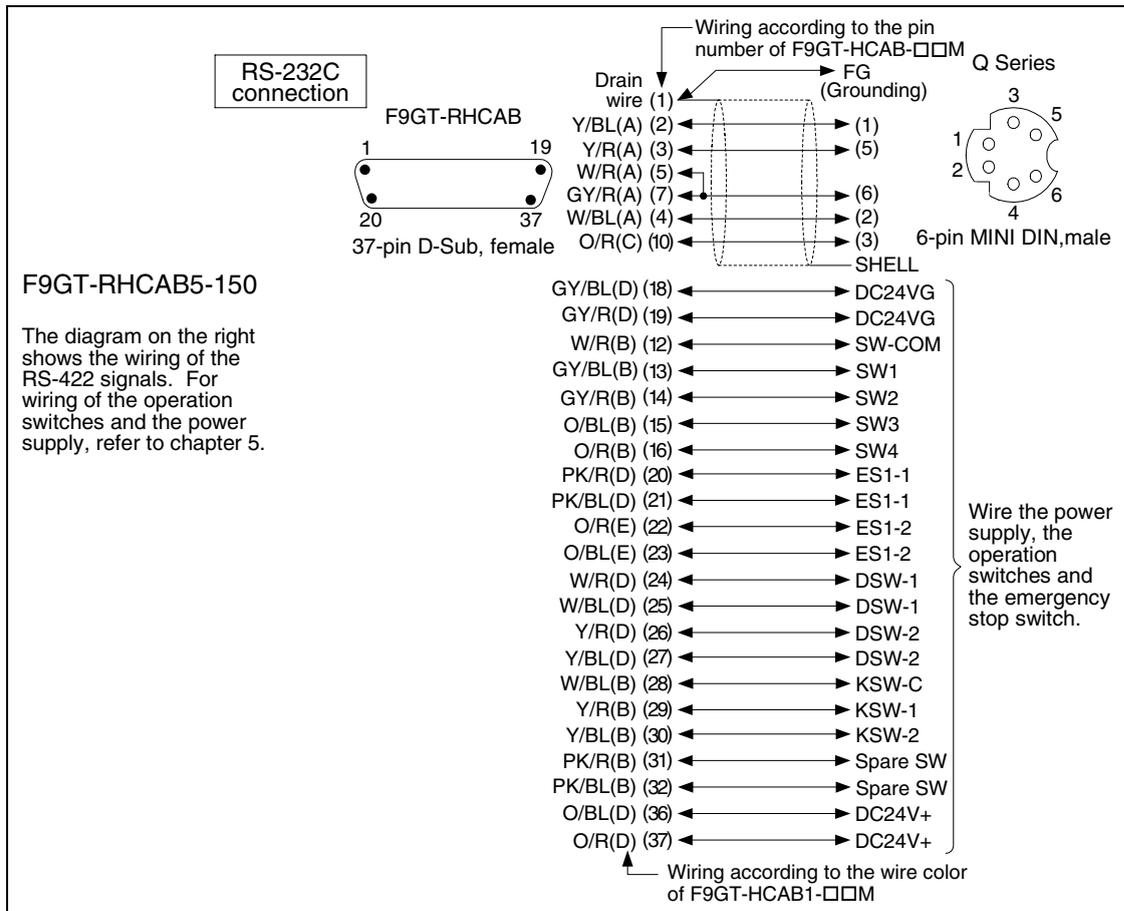
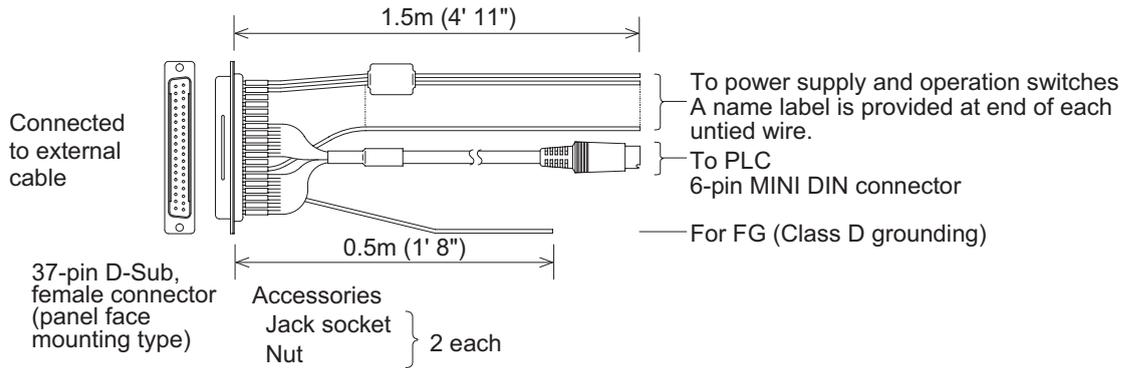

### 5.5.4 Panel Cut Dimension for Relay Cable

When mounting the relay cable connector on the panel of a control box or cabinet, prepare panel of control box or cabinet as follows.

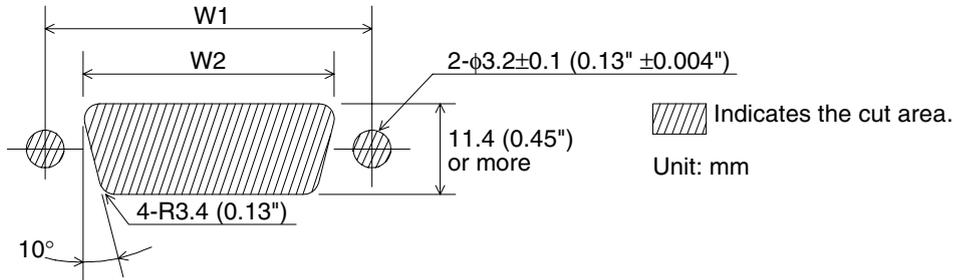

(Panel thickness: 0.8 to 1.3mm, 0.03" to 0.05")

	Handy GOT	Handy GOT RH model
Connector shape	25-pin D-Sub	37-pin D-Sub
Cable model name	F9GT-HCAB2-150 F9GT-HCAB3-150 F9GT-HCAB5-150	F9GT-RHCAB2-150 F9GT-RHCAB3-150 F9GT-RHCAB5-150
W1	47.04 (1.86")	63.5 (2.5")
W2	42.5 (1.68") or more	59.1 (2.33") or more

Insert jack sockets into the holes shown above, and tighten them with nuts M3 (0.12").

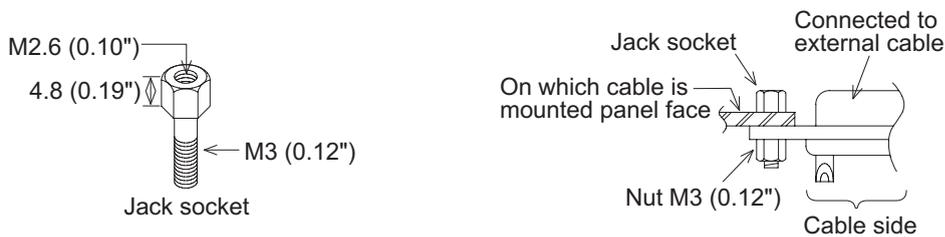

### 5.5.5 Panel Cut Dimension for F9GT-HCNB

The F9GT-HCNB can be mounted on the panel face directly or mounted using an L-shape metal fixture.

For the details of the panel cut dimension, refer to Section 5.16.

1	Introduction
2	Outline
3	Specifications
4	Installation and Wiring of F940GOT
5	Installation and Wiring of Handy GOT
6	Connection of Peripheral Equipment
7	Connection of Two or More GOT Units
8	Connection of MELSEC-F FX Series PLC
9	Connection of MELSEC-A Series PLC
10	Connection of MELSEC-QnA Series PLC

### 5.5.6 Specification change of the external/relay cable

For the compatibility with F920 Handy GOT RH model (Japan only), the specifications of the external and relay cable have been changed.

The table below explains the differences between old and new cables that can be used for F920 Handy GOT RH model (Japan only).

The new cable can be also shared with F94□ Handy GOT.

#### 1) Specification changes

Item		Model JY***C***71C or later*1	Model JY***C***71B or later*1
<b>Compatibility with Handy GOT</b>			
Compatibility with F94□ Handy GOT		✓	✓
Compatibility with F920 Handy GOT RH model		✓	–
<b>Changed items of external cable/relay cable (Refer to the next page for details.)</b>			
F9GT-HCAB-□□M	Wire	20-pin (ES1-2)	Empty pins
	Model name label	Font color: Blue	Font color: Black
F9GT-HCAB1-□□M	Wire	Orange/White	No wire
	Model name label	Font color: Blue	Font color: Black
F9GT-HCAB2-150	Wire	20-pin (ES1-2) with ferrite core	Empty pins
	Signal name label	2 labels	1 label
F9GT-HCAB3-150	Wire	20-pin (ES1-2)	Empty pins
	Signal name label	2 labels	1 label
F9GT-HCAB5-150	Wire	Not changed (This cable is for connecting to QCPU (RS-232C) and so cannot be used for F920 Handy GOT RH model.)	
	Signal name label		

\*1 The last alphabet of JY\*\*\*C\*\*\*71 indicated on the model name label is used to distinguish cables.



2) Points to be checked by the appearance

F9GT-HCAB-\*\*M  
F9GT-HCAB1-\*\*M

The character color on model name labels has been changed into blue.

F9GT-HCAB2-150

F9GT-HCAB3-150

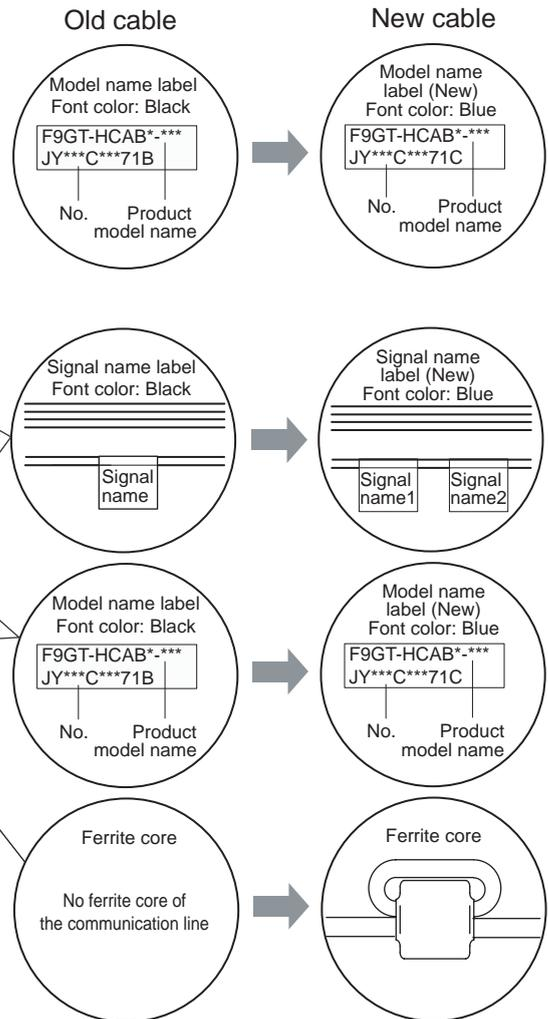

3) How to see the cable diagram

The switch signal names of the new cable differ by the Handy GOT model, so two kinds of labels, label1 and 2, are attached as follows.

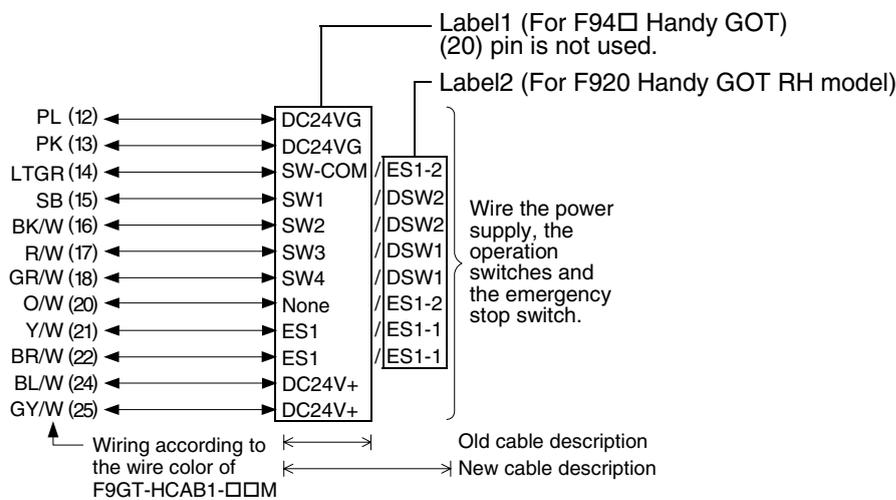

1	Introduction
2	Outline
3	Specifications
4	Installation and Wiring of F940GOT
5	Installation and Wiring of Handy GOT
6	Connection of Peripheral Equipment
7	Connection of Two or More GOT Units
8	Connection of MELSEC-FX Series PLC
9	Connection of MELSEC-A Series PLC
10	Connection of MELSEC-QnA Series PLC

## 5.6 Pin Layout and Signal Allocation of Connector for Serial Communication and Operation Switches

### 5.6.1 Cautions on preparing cables

When preparing the cables, use the wire size of 0.08mm<sup>2</sup> or more (AWG28 or more) for communication, 0.3mm<sup>2</sup> or more (AWG22 or more) for the power supply, operation switch, and emergency stop switch. Do not use a twisted pair cable for the power supply wire and the communication wire.

### 5.6.2 F9GT-HCAB□-□M/F9GT-HCAB1-□M External Cable

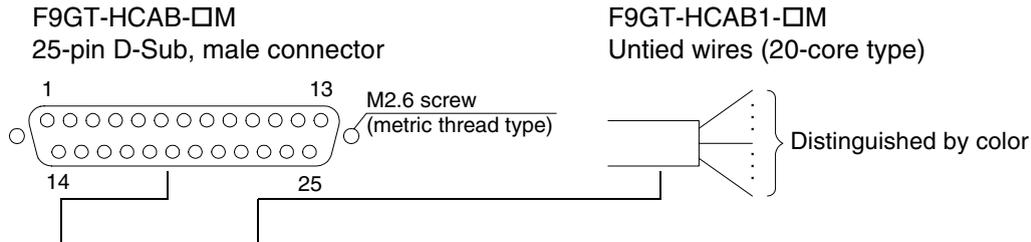

External cable		Communication/power supply/ operation switch signal name		Description	Reference
F9GT-HCAB□M	F9GT-HCAB1-□M	F940 Handy GOT	F943 Handy GOT		
D-Sub pin number	Untied wire color	RS-422	RS-232C		
1	Drain wire	FG (shield)		Frame ground	
2	Black	TXD+(SDA)	SD(TXD)	Signal wires for communication with PLC Corresponding section from chapter 8	-
3	White	TXD-(SDB)	ER(DTR)		
4	Red	RTS+(RSA)	RD(RXD)		
5	Green	RTS-(RSB)	DR(DSR)		
6	Yellow	RXD+(RDA)	RS(RTS)		
7	Brown	RXD-(RDB)	CS(CTS)		
8	Blue	CTS+(CSA)	NC		
9	Gray	CTS-(CSB)	NC		
10	Orange	SG		Signal ground	
11	-	NC		Not used	
12	Purple	DC 24VG		Minus side of the 24V DC power supply "-" of the main unit	5.8
13	Pink				
14	Light green	SW-COM (common)		Operation switches	5.9
15	Sky blue	SW1			
16	Black/white	SW2			
17	Red/white	SW3			
18	Green/white	SW4			
19	-	NC		Not used	
20	-	NC			
21	Yellow/white	ES1		Emergency stop switch (Both ends of the contact of the switch are present here.)	5.10
22	Brown/white	ES1			
23	-	NC			
24	Blue/white	DC 24V +		Plus side of the 24V DC power supply "+" of the main unit	5.8
25	Gray/white				

The grip switch is not in the table because there is no need of wiring.

5.6.3 F9GT-RHCAB-□M External Cable

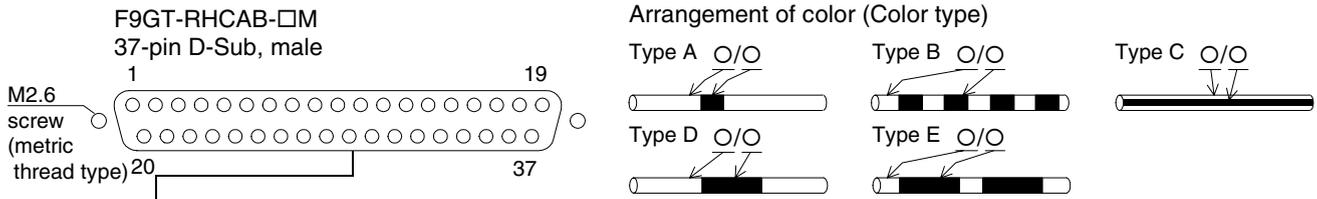

External cable		Communication/power supply/operation switch signal name		Description	Reference
F9GT-HCAB-□M	F9GT-HCAB1-□M	F940 Handy GOT	F943 Handy GOT		
D-Sub pin number	Wire color (Color type)	RS-422	RS-232C		
1	Shield	FG (shield)		Frame ground	Corresponding chapters
2	Yellow/Blue (A)	TXD+ (SDA)	SD (TXD)	Note 1	
3	Yellow/Red (A)	TXD- (SDB)	ER (DTR)		
4	White/Blue (A)	RTS+ (RSA)	RD (RXD)		
5	White/Red (A)	RTS- (RSB)	DR (DSR)		
6	Gray/Blue (A)	RXD+ (RDA)	RS (RTS)		
7	Gray/Red (A)	RXD- (RDB)	CS (CTS)		
8	Orange/Blue (A)	CTS+ (CSA)	NC		
9	Orange/Red (A)	CTS- (CSB)	NC		
10	Orange/Red (C)	SG			Signal ground
11	-	NC		Not used	
12	White/Red (B)	SW-COM		Common for Operation switches	5.9
13	Gray/Blue (B)	SW1		Operation switches	
14	Gray/Red (B)	SW2			
15	Orange/Blue (B)	SW3			
16	Orange/Red (B)	SW4			
17	-	NC		Not used	
18	Gray/Blue (D)	DC24V G		24V DC power supply "-"	5.8
19	Gray/Red (D)				
20	Pink/Red (D)	ES1-1		Emergency stop switch	5.10
21	Pink/Blue (D)	ES1-1			
22	Orange/Red (E)	ES1-2			
23	Orange/Blue (E)	ES1-2			
24	White/Red (D)	DSW-1		Grip switch	5.12
25	White/Blue (D)	DSW-1			
26	Yellow/Red (D)	DSW-2			
27	Yellow/Blue (D)	DSW-2			
28	White/Blue (B)	KSW-C		Common for keylock switch	4.13
29	Yellow/Red (B)	KSW-1		Keylock switch	
30	Yellow/Blue (B)	KSW-2			
31	Pink/Red (B)	Spare SW			
32	Pink/Blue (B)	Spare SW		Spare	
33,34,35	-	NC		Not used	
36	Orange/Blue (D)	DC 24V+		24V DC power supply "+"	4.8
37	Orange/Red (D)				

**Note 1:** These are signals for communication with the PLC. When connecting to a port other than the programming port of the FX, A, QnA or Q series PLC, refer to the manual of the connected module. Also use a relay cable. For relay cable details, refer to Section 5.5.3.

1	Introduction
2	Outline
3	Specifications
4	Installation and Wiring of F940GOT
5	Installation and Wiring of Handy GOT
6	Connection of Peripheral Equipment
7	Connection of Two or More GOT Units
8	Connection of MELSEC-FX Series PLC
9	Connection of MELSEC-A Series PLC
10	Connection of MELSEC-QnA Series PLC

### 5.7 Outline of Internal Wiring

The Handy GOT is equipped with the following switches and indicator LEDs shown below.

#### Handy GOT (Excluding RH model)

##### 1) Switch assignment

The figure below shows the switch assignment. Each switch is expressed in abbreviations as follows.

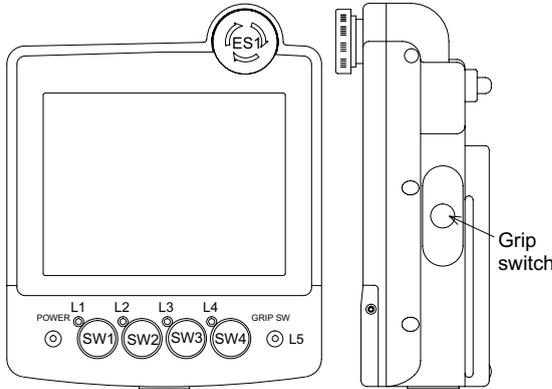

Abbreviation	Name	Reference
SW1~SW4	Operation switches	5.9.1
ES1	Emergency stop switch	5.10
L1~L4	Indicator LEDs for operation switches	5.9.1
L5	Indicator LED for grip switch	5.11
-	Grip switch	

#### Switches requiring external wiring

The following switches have to be connected to the PLC or external input equipment through the operation switch connector.

- Operation switches
- Emergency stop switch

#### Switch and LEDs not requiring external wiring

Because the following switch and LEDs are connected to the display unit CPU and ready for serial communication with the PLC through the communication port, they do not have to be wired.

- Grip switch and indicator LED for grip switch
- Indicator LEDs for operation switches

##### 2) Internal wiring of switches

Each switch on the previous page is wired inside the Handy GOT as shown below.

This chapter explains the wiring of external cable is explained here.

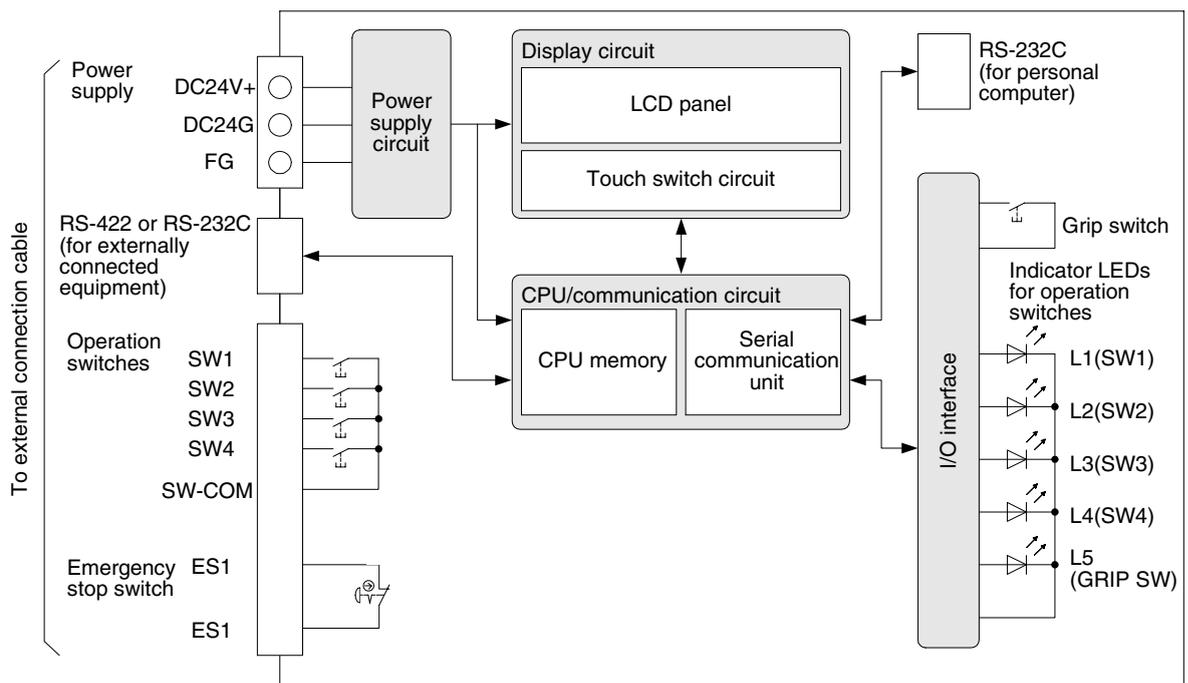

**Handy GOT RH model**

**1) Switch assignment**

The figure below shows the switch assignment. Each switch is expressed in abbreviations as follows.

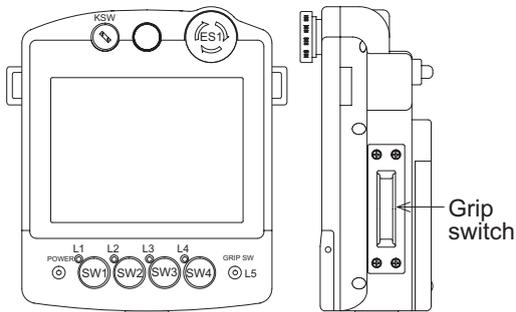

Abbreviation	Name	Reference
SW1~SW4	Operation switches	5.9.1
ES1	Emergency stop switch	5.10
KSW1,KSW2	Keylock switch	5.13
L1~L4	Indicator LEDs for operation switches	5.9.1
L5	Indicator LED for grip switch	5.12.4
DSW1,DSW2	Grip switch	5.12

**Switches requiring external wiring**

The following switches have to be connected to the PLC or external input equipment through the operation switch connector.

- Operation switches
- Emergency stop switch
- Grip switch
- Keylock switch

**LEDs not requiring external wiring**

Because the following switch and LEDs are connected to the display unit CPU and ready for serial communication with the PLC through the communication port, they do not have to be wired.

- Indicator LED for grip switch
- Indicator LEDs for operation switches

**2) Internal wiring of switches**

Each switch on the previous page is wired inside the Handy GOT as shown below.

The connectors CN1 to CN5 (except CN3) are connected to the PLC via an external cable (F9GT-RHCAB-□M).

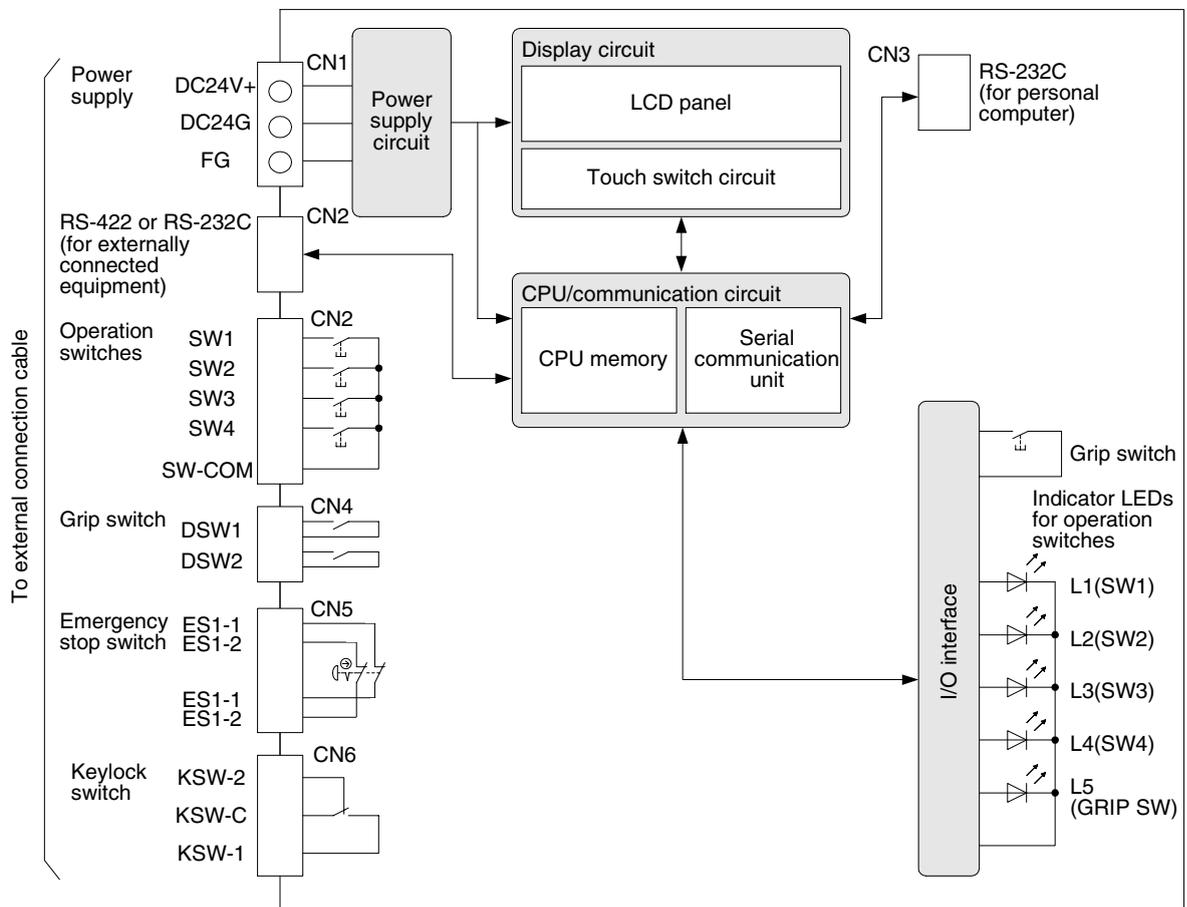

1	Introduction
2	Outline
3	Specifications
4	Installation and Wiring of F940GOT
5	Installation and Wiring of Handy GOT
6	Connection of Peripheral Equipment
7	Connection of Two or More GOT Units
8	Connection of MELSEC-FX Series PLC
9	Connection of MELSEC-A Series PLC
10	Connection of MELSEC-QnA Series PLC

### 5.8 Wiring for 24V DC Power Supply and Class D Grounding

The power is supplied from the external power supply to the Handy GOT.  
The current consumption is 300mA at 24V DC.

#### Example when the power is supplied from the external power supply

Connect the power cable (untied wires) or connector of the Handy GOT to the 24V DC external power supply.

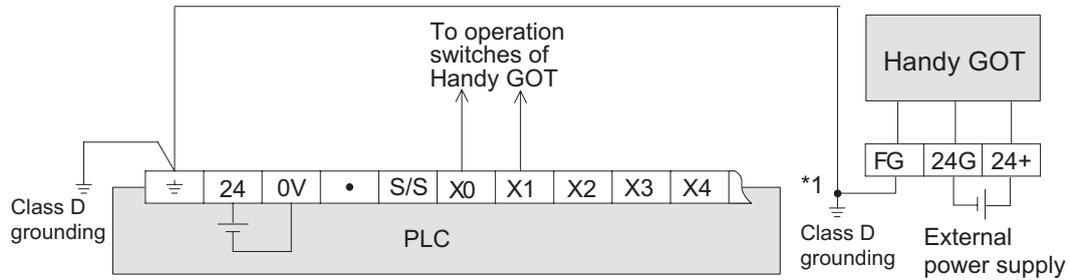

\*1 Caution on class D grounding according to input power supply

a) When the input power supply is equivalent

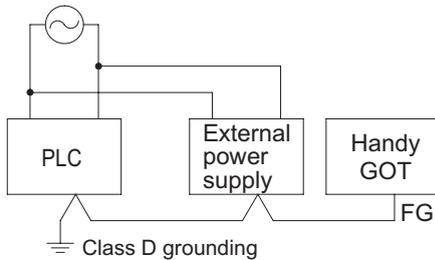

When the input power for the PLC main unit is equivalent to the input power for the external power supply (24V DC), grounding may be performed by connecting the frame ground of the Handy GOT to the ground terminal ( ≡ ) of the PLC.

b) When the input power supply is different

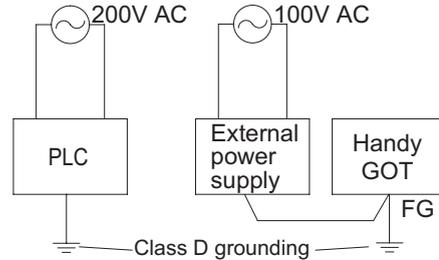

When the input power supply of the external power supply is different (PLC: 200V AC, external power supply: 100V AC), perform dedicated grounding to each of the PLC and Handy GOT separately.

**Pin layout**

Model name	Signal name		
	DC24+	DC24VG	FG
<b>F943 Handy GOT</b>			
External cable			
F9GT-HCAB-□M	24, 25	12, 13	1
F9GT-HCAB1-□M	Blue/White, Gray/White	Purple, Pink	Drain wire
<b>F940 Handy GOT</b>			
External cable			
F9GT-HCAB-□M	24, 25	12, 13	1
F9GT-HCAB1-□M	Blue/White, Gray/White	Purple, Pink	Drain wire
Connector conversion box			
F9GT-HCNB	DC24V+	DC24VG	FG
<b>F940 Handy GOT RH model, F943 Handy GOT RH model</b>			
External cable			
F9GT-RHCAB-□M	36, 37	18, 19	1
F9GT-RHCAB1-□M	Orange/Blue (D) Orange/Red (D)	Gray/Blue (D) Gray/Red (D)	Shield wire

For the wire color of F9GT-HCAB1-□M, F9GT-RHCAB1-□M, refer to Section 5.6.

**Recommended feature size of terminal (H9GT-HCNB conversion box)**

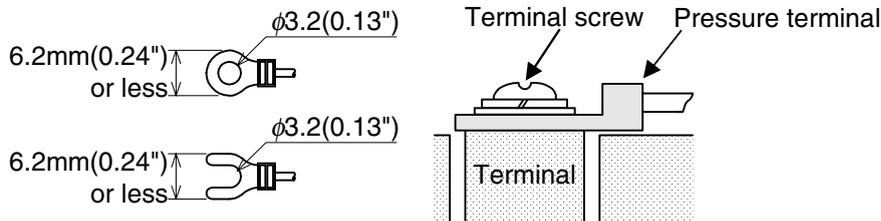

1	Introduction
2	Outline
3	Specifications
4	Installation and Wiring of F940GOT
5	Installation and Wiring of Handy GOT
6	Connection of Peripheral Equipment
7	Connection of Two or More GOT Units
8	Connection of MELSEC-F FX Series PLC
9	Connection of MELSEC-A Series PLC
10	Connection of MELSEC-QnA Series PLC

## 5.9 Wiring and Handling of Operation Switches SW1 to SW4

This section explains the wiring and the use of the operation switches and the grip switch as well as control of the LEDs for confirming pressing of the switches.

### 5.9.1 Handling of operation switches

This section explains the use of the operation switches and control of the LEDs for confirming pressing of the switches.

The switches should be wired by the user. LED indication is executed through communication.

#### 1) Wiring the operation switches

The operation switches are assigned as follows, and connected to the PLC through an external cable.

##### Connection example

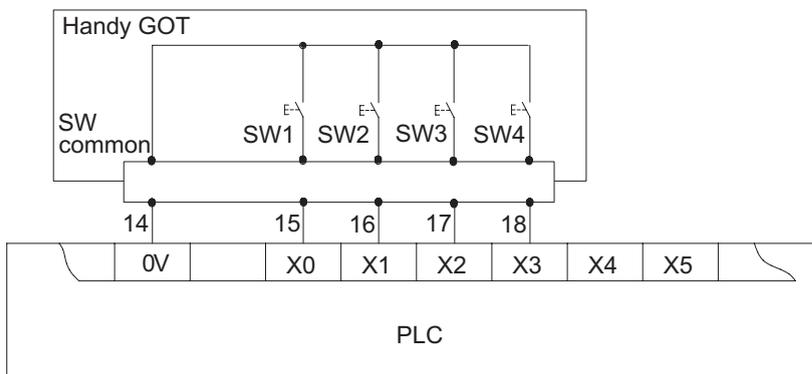

##### Pin layout

Model name	Signal name				
	SW-COM	SW1	SW2	SW3	SW4
<b>F943 Handy GOT</b>					
External cable					
F9GT-HCAB-□M	14	15	16	17	18
F9GT-HCAB1-□M	Light green	Sky blue	Black/White	Red/White	Green/White
<b>F940 Handy GOT</b>					
External cable					
F9GT-HCAB-□M	14	15	16	17	18
F9GT-HCAB1-□M	Light green	Sky blue	Black/White	Red/White	Green/White
Connector conversion box					
F9GT-HCNB	SW-COM	SW1	SW2	SW3	SW4
<b>F940 Handy GOT RH model, F943 Handy GOT RH model</b>					
External cable					
F9GT-RHCAB-□M	12	13	14	15	16
F9GT-RHCAB1-□M	White/Red (B)	Gray/Blue (B)	Gray/Red (B)	Orange/Blue (B)	Orange/Red (B)

For the wire color of F9GT-HCAB1-□M, F9GT-RHCAB1-□M, refer to Section 5.6.



**2) Input of operation switches**

Use the operation switches of the Handy GOT as follows.

**How to use the operation switches**

Because the operation switches SW1 to SW4 are directly connected to inputs of the PLC, they can be controlled freely by programs in the PLC in the same way as general inputs.

- An operation switch is taken into the PLC as a momentary type switch with N/O contact.

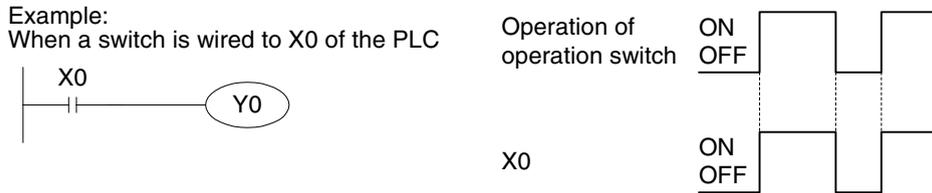

- When you would like to treat input of an operation switch as N/C contact or an alternate type switch, create a proper program in the PLC.

**3) Lighting of LEDs for confirming operation**

A green LED is provided for each of four operation switches SW1 to SW4 and one grip switch so that pressing of each switch can be confirmed.

Each LED is assigned to a bit device by the screen creation software. When the value of a bit device is "1", the corresponding switch is lit. When the value is "0", the corresponding switch is extinguished.

a) Assignment of devices controlling the LEDs

Device	Name
M100	Operation switch SW1 (green)
M101	Operation switch SW2 (green)
M102	Operation switch SW3 (green)
M103	Operation switch SW4 (green)
M104	Grip switch (green)

← Set this device using the screen creation software. The LEDs for the operation switches and grip switch can be allocated successively.

← Valid when the OS version is 6.00 or later

b) Setting in the screen creation software

The head device for the LEDs of the operation switches should be set in the screen creation software.

For the details, refer to Section 5.14.

c) Program example

The operation switches SW1, SW2, SW3 and SW4 are assigned to X0, X1, X2 and X3 respectively. The grip switch is wired to X4.

The device of "Output Indicator" is set to M100 in the screen creation software.

In a sequence program, inputs X0 to X4 are assigned to M100 to M104 using the OUT instruction.

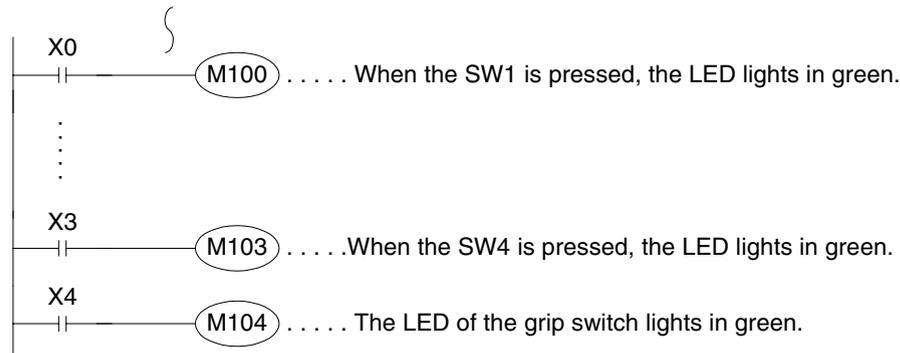

1 Introduction

2 Outline

3 Specifications

4 Installation and Wiring of F940GOT

5 Installation and Wiring of Handy GOT

6 Connection of Peripheral Equipment

7 Connection of Two or More GOT Units

8 Connection of MELSEC-FX Series PLC

9 Connection of MELSEC-A Series PLC

10 Connection of MELSEC-QnA Series PLC

### 5.9.2 Preparation of Operation Switch Name Sheet

This section explains how to prepare the operation switch name sheet.

#### 1) Preparing the name sheet

- a) Use a name sheet and an OHP sheet (transparent sheet) offered as accessories.
- b) The mount sheet is of actual dimensions.  
If you would like to make additional mount sheets, refer to the following dimensions.

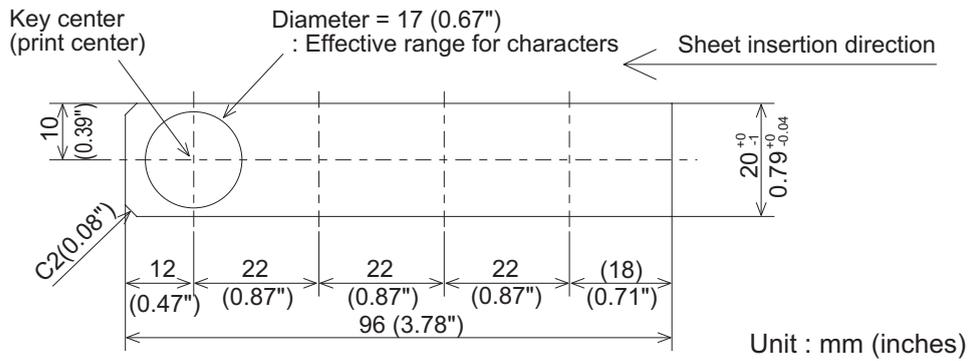

- c) When the work in b) is completed, copy the contents of the name sheet base on an OHP sheet in the actual dimensions (100%) using a copy machine.  
When using a different OHP sheet, use the following type. Make sure that the selected OHP sheet can be used in a copy specification.

[Recommended OHP sheet]  
Material: Polyester film  
Thickness: 0.1mm (0.004")

**2) Attaching the sheet**

a) Remove the operation switch cover.

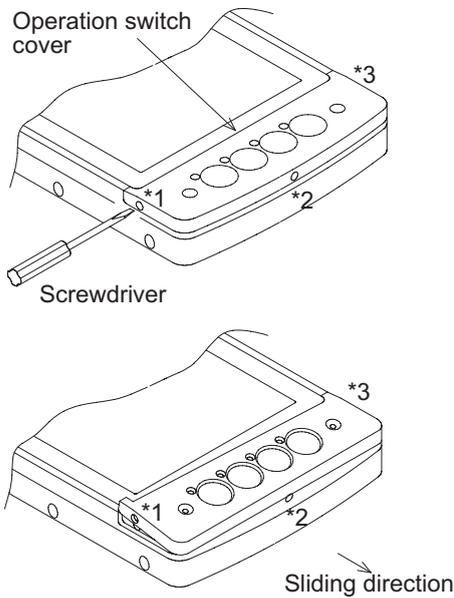

Insert a screwdriver into the clearance \*1 or \*3 between the operation switch cover and the main unit, then slowly push the switch cover up.

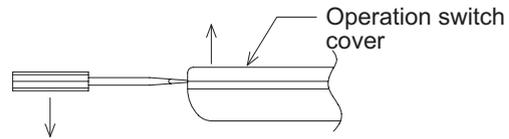

When the either side \*1 or \*3 comes off, pull it in the sliding direction shown on the left to remove it.

b) Insert the sheet.

Insert it into the following position shown below of the Handy GOT.

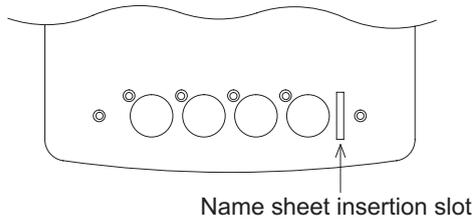

c) Attach the operation switch cover.

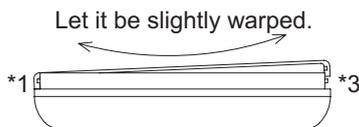

Align the operation switch cover with a protrusion in the position \*1 or \*3 shown in the figure in a) above, then attach the operation switch cover while flexing it slightly.

### 5.10 Wiring and Handling of Emergency Stop Switch (ES1)

The emergency stop switch is assigned as shown below.

#### 5.10.1 Cautions on preparing cables

When preparing the cables, use the wire size of 0.08mm<sup>2</sup> or more (AWG28 or more) for communication, 0.3mm<sup>2</sup> or more (AWG22 or more) for the power supply, operation switch, and emergency stop switch. Do not use a twisted pair cable for the power supply wire and the communication wire.

#### 5.10.2 Connection figure of cable

##### Handy GOT (Excluding RH model)

##### 1) Connection example

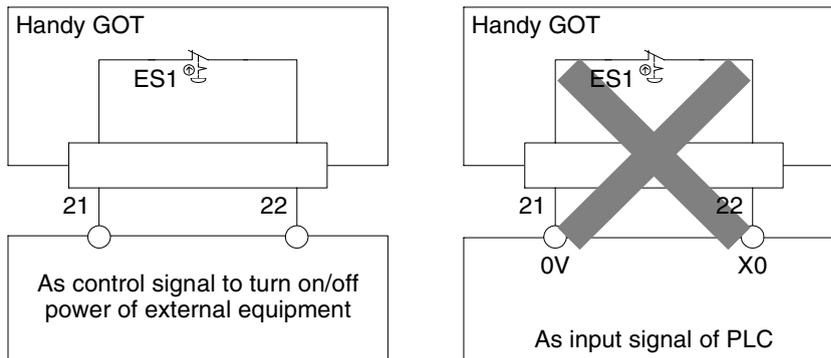

When turning on and off the power of external equipment, make sure that the load is 24V DC, 1 A (contact specifications) or less. Make sure to construct the emergency stop circuit outside the PLC.

##### 2) Pin assignment

Model name	Signal name	
	ES1	ES1
<b>F940 Handy GOT</b>		
External cable		
F9GT-HCAB-□M	21	22
F9GT-HCAB1-□M	Yellow/White	Brown/White
Connector conversion box		
F9GT-HCNB	ES1	ES1
<b>F943 Handy GOT</b>		
External cable		
F9GT-HCAB-□M	21	22
F9GT-HCAB1-□M	Yellow/White	Brown/White

For the wire color of F9GT-HCAB1-□M, refer to Section 5.6.2.

##### 3) Used switch model name

Model name	AH165-VR01 (manufactured by Fuji Electric)
Specifications	N/C contact, 1 A/24V DC individual wiring

4) Caution on use



The emergency stop switch is the N/C contact type. If the Handy GOT is attached and removed using a connector, when it is removed from the machine, the switches turn OFF from ON. This is the status in which the emergency stop switch is pressed. This fact should be taken into consideration in the design.

Handy GOT RH model

1) Connection example

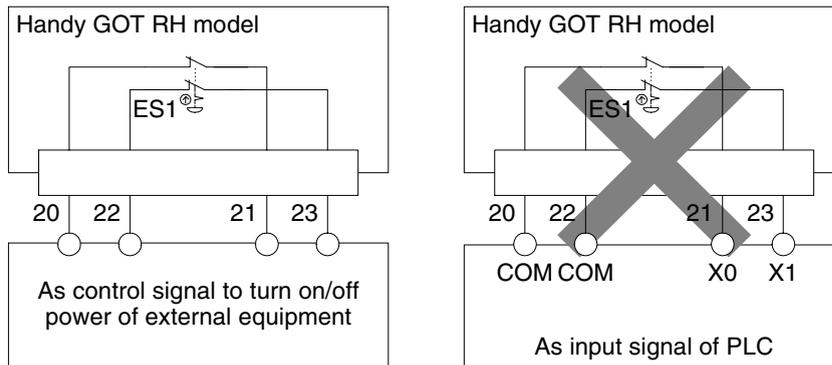

When turning on and off the power of external equipment, make sure that the load is 24V DC, 1 A (contact specifications) or less. Make sure to construct the emergency stop circuit outside the PLC.

2) Pin assignment

Model name	Signal name			
	ES1-1	ES1-1	ES1-2	ES1-2
F940 Handy GOT RH model, F943 Handy GOT RH model				
External cable				
F9GT-RHCAB-□M	20	21	22	23
F9GT-RHCAB1-□M	Pink/Red (D)	Pink/Blue (D)	Orange/Red (D)	Orange/Blue (D)

For the wire color of F9GT-RHCAB1-□M, refer to Section 5.6.3.

3) Used switch model name

Model name	AH165-VR02 (manufactured by Fuji Electric)
Specifications	2b contact, 1 A/24V DC individual wiring

4) Caution on use



The emergency stop switch is the N/C contact type. If the Handy GOT is attached and removed using a connector, when it is removed from the machine, the switches turn OFF from ON. This is the status in which the emergency stop switch is pressed. This fact should be taken into consideration in the design.

1	Introduction
2	Outline
3	Specifications
4	Installation and Wiring of F940GOT
5	Installation and Wiring of Handy GOT
6	Connection of Peripheral Equipment
7	Connection of Two or More GOT Units
8	Connection of MELSEC-F FX Series PLC
9	Connection of MELSEC-A Series PLC
10	Connection of MELSEC-QnA Series PLC

### 5.11 Handling of grip switch (excluding RH model)

Because the grip switch executes communication with connected equipment, wiring is not required.

#### 5.11.1 Function of Grip Switch

The grip switch is provided on the side of the Handy GOT. While the grip switch (N/O contact type) is being pressed manipulation of the touch keys on the screen is effective.

The ON/OFF status of the grip switch can be monitored by the PLC.

In the OS version 6.00 or later, you can select handling of the grip switch and the LED control method.

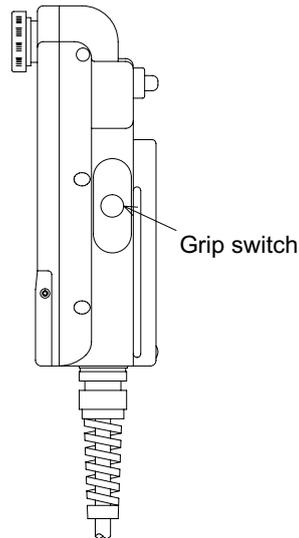

#### 5.11.2 Setting in main unit and screen creation software

Make the grip switch valid or invalid in "SET-UP MODE" of the Handy GOT or the screen creation software. (The priority is given to writing in the screen creation software.) (The default value is "USE" (valid).)

In the OS version 6.00 or later, if the grip switch is set valid, the touch key OFF operation can be changed by the grip switch as described in "3) Switch OFF operation" in the next section. (For the details, refer to the next page.)

For the detailed setting procedure, refer to Section 5.14.

##### 1) Setting in the main unit

###### When the OS version is 6.00 or later

Set the grip switch valid ("USE") or invalid ("DON'T USE") in "HANDY GOT SETTING" in "SET-UP MODE".

HANDY GOT SETTING	END
GRIP SWITCH: <input type="text" value="USE"/>	
PUSH BUTTON WRITE: <input type="text" value="DOES NOT WRITE"/>	
SWITCH OFF ACTION: <input type="text" value="TOUCH SWITCH OFF"/>	
LED ACTION: <input type="text" value="CONCURRENTLY WITH GRIP SWITCH"/>	

When using the grip switch, press the screen to display "USE".

These items are added in the OS version 6.00. For the details, refer to the next section.

**When the OS Version is earlier than 6.00**

Set the grip switch valid ("USE") or invalid ("DON'T USE") in "GRIP SWITCH" in "SET-UP MODE" in the Handy GOT.

GRIP SWITCH	END
GRIP SWITCH: <input type="text" value="USE"/>	

When using the grip switch, press the screen to display "USE".

**2) Setting in the screen creation software**

The grip switch can be set in the GT Designer and the DU/WIN.

If a screen is created using the screen creation software whose version does not correspond the Handy GOT, the grip switch is always valid on the screen.

For setting of items other than the grip switch, the screen creation software of proper version is required.

**5.11.3 Grip switch operation specifications****1) Grip switch (valid/invalid)**

When "GRIP SWITCH" is set to "USE" (valid), touch keys (on user screens) in the screen mode are enabled while the grip switch is being pressed.

Availability of the grip switch is being set to all user screens.

On system screens, touch keys are always enabled.

Screen type	Screen number	Grip switch function
User screen	1 ~ or 0 ~ *1	Valid (While the grip switch is being pressed, touch keys are enabled and offer the screen changeover function and the switch function.)
System screen	1001~	Invalid (Without regard to the ON/OFF status of the grip switch, touch keys are always enabled and offer the screen changeover function and the switch function.)

\*1 The head number of the user screen number varies depending on the screen creation software.

When "GRIP SWITCH" is set to "DON'T USE", touch keys are always enabled without regard to the ON/OFF status of the grip switch.

**2) Write of the grip switch ON/OFF status**

It can be selected whether the grip switch ON/OFF switch is communicated with the PLC.

When "GRIP SWITCH" is set to "DON'T USE", "PUSH BUTTON WRITE" can be set to "DOES NOT WRITE" or "WRITE".

When "GRIP SWITCH" is set to "USE", "PUSH BUTTON WRITE" can be set to only "WRITE".

For the details of communication with the connected equipment, refer to the previous section.

3) Switch OFF operation

a) Basic operation

While the grip switch is set valid in the Handy GOT, it controls the operations of touch keys, numerical inputs and ASCII inputs (hereafter referred to as touch keys as representative). While the grip switch is being pressed (ON status), the touch key operation is enabled as follows. While the grip switch is released (OFF status), the touch key operation is disabled and any operation from the touch panel is disabled.

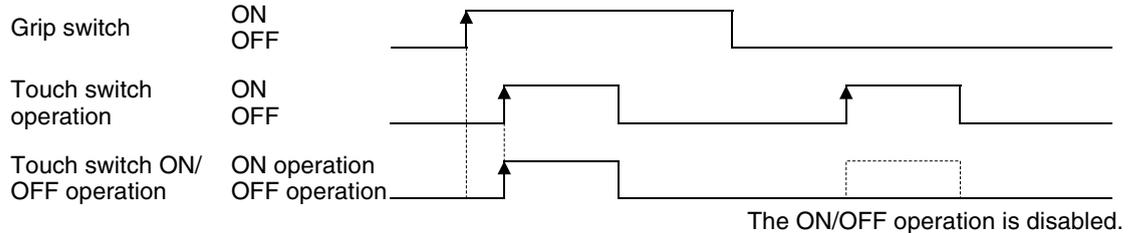

b) ON/OFF operation timing

When "SWITCH OFF ACTION" is set to "TOUCH KEY OFF"

While the grip switch is ON, the touch key ON operation is executed when the touch key turns ON.

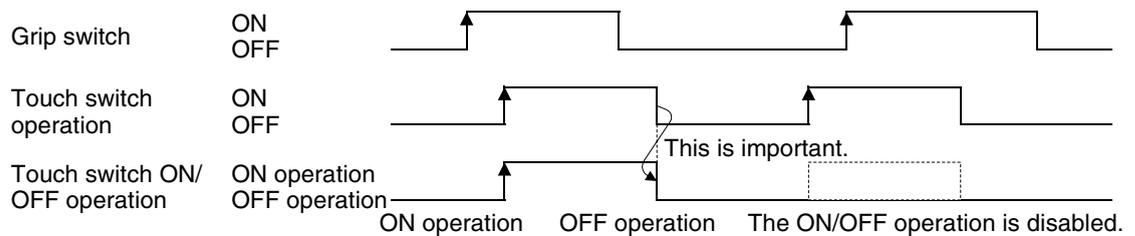

**Important point**

The (momentary) touch key operation is not related to the grip switch ON/OFF status. When the touch key turns OFF from ON, the control target bit device is set to OFF.

When "SWITCH OFF ACTION" is set to "GRIP SWITCH OFF"

While the grip switch is ON, the touch key ON operation is executed when the touch key turns ON.

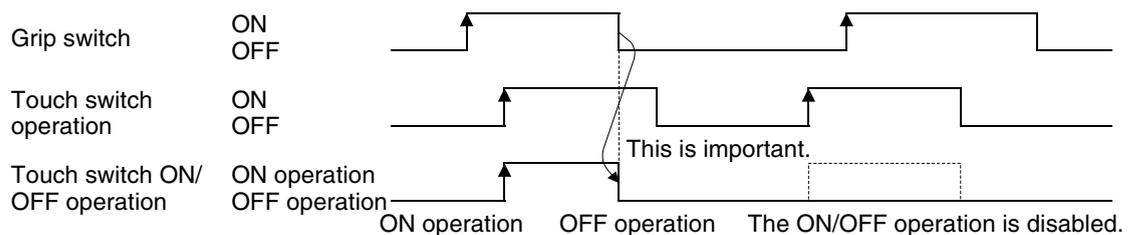

**Important point**

The (momentary) touch key operation is related to the grip switch ON/OFF status. Even while a touch key is ON, the control target bit device is set to OFF when the grip switch is released.

c) Others

When the grip switch is pressed while the screen is blacked out by the screen save function, the screen save function is released and the screen display becomes active.



#### 4) LED operation

It can be selected whether the LED ON/OFF status indicating the grip switch pressing status is controlled by "CONCURRENTLY WITH GRIP SWITCH", "CONCURRENTLY WITH BIT DEVICE" or "ALWAYS OFF".

Selection item	Description
CONCURRENTLY WITH GRIP SWITCH	While the grip switch is being pressed, the LED on the front panel is lit.
CONCURRENTLY WITH BIT DEVICE	The LED on the front panel is lit or extinguished by a bit device of the PLC.
ALWAYS OFF	The LED on the front panel is always extinguished.

When "LED ACTION" is set to "CONCURRENTLY WITH BIT DEVICE", the setting to assign a bit device of the PLC is required. For the details, refer to Section 5.8.

1

Introduction

2

Outline

3

Specifications

4

Installation  
and Wiring of  
F940GOT

5

Installation  
and Wiring of  
Handy GOT

6

Connection of  
Peripheral  
Equipment

7

Connection of  
Two or More  
GOT Units

8

Connection of  
MELSEC-F FX  
Series PLC

9

Connection of  
MELSEC-A  
Series PLC

10

Connection of  
MELSEC-QnA  
Series PLC

**5.11.4 Communication with connected equipment (grip switch ON/OFF signal)**

The grip switch ON/OFF status can be confirmed in a bit device. (Have in mind that the bit device number varies depending on the screen creation software.)

In the Handy GOT, while the grip switch is being pressed, the GRIP SW LED on the front face is lit in green.

**1) Assignment of device used to confirm the grip switch ON/OFF status**

Assign a device used to confirm the grip switch ON/OFF status using the screen creation software.

a) In the case of screen creation software GT Designer2

Select "Common"->"System Environment" from the menu bar, then click "System Information" in the tree. Or double-click "Common Settings"->"System Environment" in the tree displayed in the project work space, then click "System Information" in the tree.

The system signal 2 (write device +4) set in "Write Device" is assigned to the grip switch.

The figure below shows the relationship between bits in the system signal area and the grip switch. When the bit value is "1", the grip switch is ON. When it is "0", the grip switch is OFF.

**System signal 2**

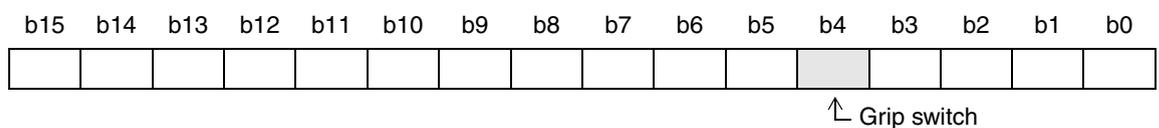

**In the case of data created using the DU/WIN**

When the data created using the DU/WIN is read from a file (only in the GOT-F900) or from the GOT-F900, the bit positions are as shown below.

Select "Common"->"System Environment" from the menu bar, then click "System Information" in the tree. Or double-click "Common Settings"->"System Environment" in the tree displayed in the project work space, then click "System Information" in the tree.

**Bit device**

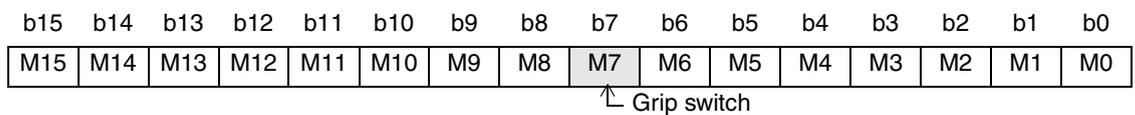

b) In the case of screen creation software GT Designer

In "Common" on the menu, set "Write device" in "System Information". Then, the specified write word device +4 is assigned to the grip switch.

The figure below shows the relationship between bits in the system signal area and the grip switch. When the bit value is "1", the LED is ON. When it is "0", the LED is OFF.

**Write device +4 (System signal 2)**

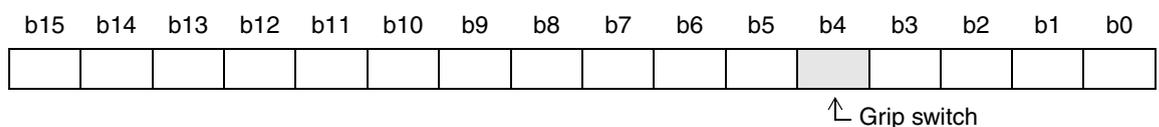

c) In the case of screen creation software DU/WIN

On the menu, set "Bit Device" in "View/Project" - "System Settings" - "Interface Devices". Then, the 8th bit device is assigned to the grip switch.

The figure below shows the relationship between bits in the system signal area and the grip switch. When the bit value is "1", the LED is ON. When it is "0", the LED is OFF.

**Bit device**

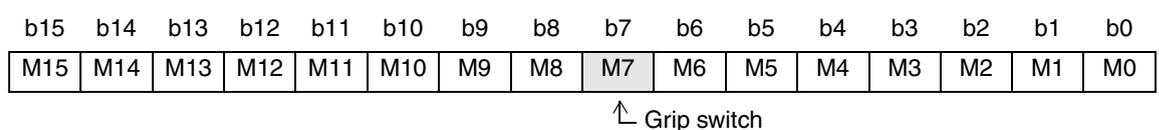

## 2) Program example

### When the OS version is 6.00 or later

It can be selected whether communication with the PLC is enabled even while the grip switch is invalid. The grip switch LED ON/OFF status can be controlled from the PLC.

#### a) In the case of screen creation software (GT Designer2 and GT Designer)

When the grip switch is set to ON or OFF, the 5th bit (b4) of the write device in the system information turns ON or OFF.

Example: When "Write device" in "System Information" is set to D20  
D24 b4: Grip switch ON (which turns ON when the grip switch is pressed)

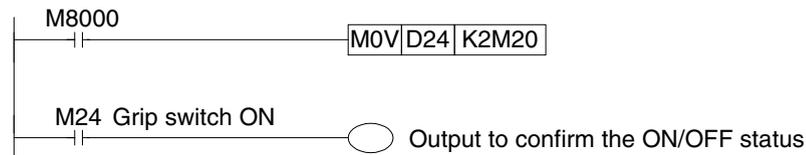

#### b) In the case of screen creation software DU/WIN

When the grip switch is set to ON or OFF, the 8th bit (b7) of the control device turns ON or OFF.

Example: When "Bit Device" (head device number) in "Interface Devices" is set to M0  
M7: Grip switch ON (which turns ON when the grip switch is pressed)



### When the OS version is earlier than 6.00

While the grip switch is valid, communication with the PLC is enabled.

### 5.12 Handling of grip switch (RH model only)

The grip switch is provided on the side of the Handy GOT and wired to the input of the PLC or other device for the use as interlocking signals. Configure the system, under which operations of the Handy GOT are valid only when the grip switch is pressed halfway, using the program of PLC or the external wiring.

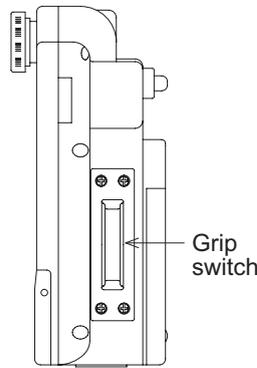

The grip switch is a 3-positioned operation switch. The ON/OFF status is shown below.

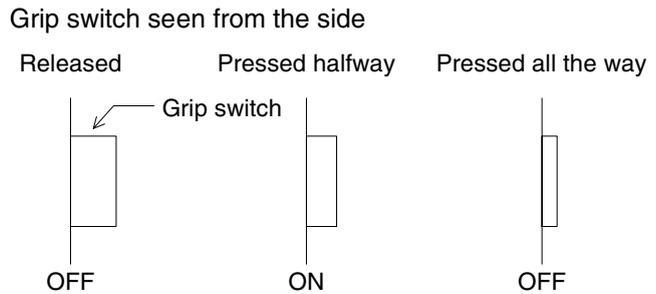

#### 5.12.1 Cautions on preparing cables

When preparing the cables, use the wire size of 0.08mm<sup>2</sup> or more (AWG28 or more) for communication, 0.3mm<sup>2</sup> or more (AWG22 or more) for the power supply, operation switch, and emergency stop switch. Do not use a twisted pair cable for the power supply wire and the communication wire.

#### 5.12.2 Wiring of Grip Switch

The grip switch is a twin contact type which performs 3-positioned operation as shown above.

##### Connection example

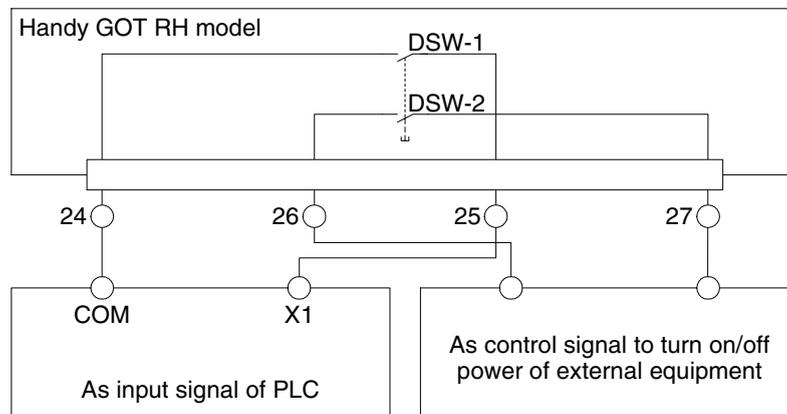

When turn on and off the control signal of external equipment, make sure that the load is 24V DC, 1A (contact specification) or less.

##### Pin assignment

Model name	Signal name			
	DSW-1	DSW-1	DSW-2	DSW-2
F940 Handy GOT RH model, F943 Handy GOT RH model				
External cable				
F9GT-RHCAB-□M	24	25	26	27
F9GT-RHCAB1-□M	White/Red (D)	White/Blue (D)	Yellow/Red (D)	Yellow/Blue (D)

For the wire color of F9GT-RHCAB1-□M, refer to Section 5.6.3.

### 5.12.3 Setting of Grip Switch LED

The grip switch LED provided on the front face of the Handy GOT can be set as follows in the main unit or screen creation software.

#### 1) Setting in Main Unit of Handy GOT

The following screen is displayed, when selecting "OTHER MODE"->"SET-UP MODE"->"HANDY GOT SETTING".

HANDY GOT SETTING      END GRIP SWITCH: <input type="text" value="USE"/> PUSH BUTTON WRITE: <input type="text" value="DOES NOT WRITE"/> SWITCH OFF ACTION: <input type="text" value="TOUCH SWITCH OFF"/> LED ACTION: <input type="text" value="CONCURRENTLY WITH GRIP SWITCH"/>	} When using RH model of Handy GOT, these settings are invalid  } Select one among "CONCURRENTLY WITH GRIP SWITCH", "CONCURRENTLY WITH BIT DEVICE" or "ALWAYS OFF".
---	---

#### 2) Setting in Screen Creation Software (GT Designer2)

- a) Select "Common"->"System Environment".
- b) Double-click "Handy GOT settings" in the tree displayed on the "System Environment" window. For the details, refer to Section 5.14.

#### 3) Setting in Screen Creation Software (GT Designer)

- a) Select "Common"->"Auxiliary Setting"->"Project".
- b) Click "Handy GOT settings" tab. For the details, refer to Section 5.14.

#### 4) Setting in Screen Creation Software (DU/WIN)

- a) Select "View/Project"->"System Settings"->"Setup Data". For the details, refer to Section 5.14.

### 5.12.4 LED Action

It can be selected whether the LED ON/OFF status indicating the grip switch pressing status is controlled by "CONCURRENTLY WITH GRIP SWITCH", "CONCURRENTLY WITH BIT DEVICE" or "ALWAYS OFF".

Selection item	Description
CONCURRENTLY WITH GRIP SWITCH	While the grip switch is being pressed, the LED on the front panel is lit.
CONCURRENTLY WITH BIT DEVICE	The LED on the front panel is lit or extinguished by a bit device of the PLC.
ALWAYS OFF	The LED on the front panel is always extinguished.

When "LED ACTION" is set to "CONCURRENTLY WITH BIT DEVICE", the setting to assign a bit device of the PLC is required. For the details, refer to Section 5.9.

1	Introduction
2	Outline
3	Specifications
4	Installation and Wiring of F940GOT
5	Installation and Wiring of Handy GOT
6	Connection of Peripheral Equipment
7	Connection of Two or More GOT Units
8	Connection of MELSEC-FX Series PLC
9	Connection of MELSEC-A Series PLC
10	Connection of MELSEC-QnA Series PLC

### 5.13 Handling of Keylock Switch (RH model only)

The keylock switch is wired to the input of the PLC or other device.

#### 1) Connection Example

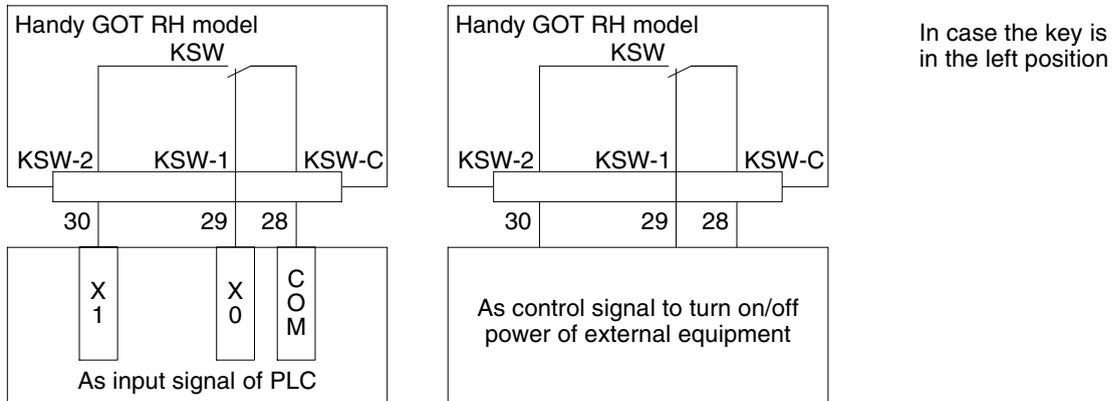

When turn on and off the control signal of external equipment, make sure that the load is 24V DC, 1A (contact specification) or less.

#### 2) Pin assignment

Model name	Signal name		
	KSW-C	KSW-1	KSW-2
<b>F940 Handy GOT RH model, F943 Handy GOT RH model</b>			
External cable			
F9GT-RHCAB-□M	28	29	30
F9GT-RHCAB1-□M	White/Blue (B)	Yellow/Red (B)	Yellow/Blue (B)

For the wire color of F9GT-RHCAB1-□M, refer to Section 5.6.3.

### 5.14 Setting of Connected Equipment for GOT

The setting in the screen creation software is required to turn on and off the LED of the operation switches and the grip switch from connected equipment. This section describes the setting method.

#### 1) GOT-F900 Series

When the main menu screen change operation is disabled.

Operation	Display (screen name)
a) While pressing and holding the upper left corner of the screen, turn on the power. Keep holding the upper left corner for about 25 seconds more. Then, press "END" at the upper right corner.	The "LANGUAGE" screen appears. The "SET-UP MODE" screen appears.
b) Press "GRIP SWITCH". <When the OS version is 6.00 or later> Press "HANDY GOT SETTING".	The "GRIP SWITCH" screen appears.
c) Set the following. "USE" (valid) or "DON'T USE"(invalid)	

When the main menu screen change operation is enabled.

Operation	Display (screen name)																				
a) Press the upper left corner of the screen. (The position to be pressed can be changed in the GOT and the screen creation software.)	The "SELECT MODE" screen appears.																				
b) Press "OTHER MODE" on the menu.	The "OTHER MODE" screen appears.																				
c) Press "SET-UP MODE" on the menu.	The "SET-UP MODE" screen appears.																				
d) Press "GRIP SWITCH". <When the OS version is 6.00 or later> Press "HANDY GOT SETTING".	The "GRIP SWITCH" screen appears.																				
e) Set the following. "USE" (valid) or "DON'T USE"(invalid) <When the OS version is 6.00 or later> The grip switch operation can be set. Press an item to be changed.																					
<div style="border: 1px solid black; padding: 5px; margin-bottom: 10px;"> <table border="1" style="width: 100%; border-collapse: collapse;"> <tr> <td style="width: 80%;">HANDY GOT SETTING</td> <td style="width: 20%; text-align: right;">END</td> </tr> <tr> <td>GRIP SWITCH: <input type="text" value="USE"/></td> <td></td> </tr> <tr> <td>PUSH BUTTON WRITE: <input type="text" value="DOES NOT WRITE"/></td> <td></td> </tr> <tr> <td>SWITCH OFF ACTION: <input type="text" value="TOUCH SWITCH OFF"/></td> <td></td> </tr> <tr> <td>LED ACTION: <input type="text" value="CONCURRENTLY WITH GRIP SWITCH"/></td> <td></td> </tr> </table> </div> <p style="margin-left: 20px;">When using the grip switch, press the screen to display "USE".</p> <p style="margin-left: 20px;">These items are added in the OS version 6.00.</p> <p>When using RH model</p> <div style="border: 1px solid black; padding: 5px; margin-bottom: 10px;"> <table border="1" style="width: 100%; border-collapse: collapse;"> <tr> <td style="width: 80%;">HANDY GOT SETTING</td> <td style="width: 20%; text-align: right;">END</td> </tr> <tr> <td>GRIP SWITCH: <input type="text" value="USE"/></td> <td></td> </tr> <tr> <td>PUSH BUTTON WRITE: <input type="text" value="DOES NOT WRITE"/></td> <td></td> </tr> <tr> <td>SWITCH OFF ACTION: <input type="text" value="TOUCH SWITCH OFF"/></td> <td></td> </tr> <tr> <td>LED ACTION: <input type="text" value="CONCURRENTLY WITH GRIP SWITCH"/></td> <td></td> </tr> </table> </div> <p style="margin-left: 20px;">These settings are invalid.</p> <p>&lt;When the OS version is earlier than 6.00&gt; Only the grip switch operation can be set.</p>	HANDY GOT SETTING	END	GRIP SWITCH: <input type="text" value="USE"/>		PUSH BUTTON WRITE: <input type="text" value="DOES NOT WRITE"/>		SWITCH OFF ACTION: <input type="text" value="TOUCH SWITCH OFF"/>		LED ACTION: <input type="text" value="CONCURRENTLY WITH GRIP SWITCH"/>		HANDY GOT SETTING	END	GRIP SWITCH: <input type="text" value="USE"/>		PUSH BUTTON WRITE: <input type="text" value="DOES NOT WRITE"/>		SWITCH OFF ACTION: <input type="text" value="TOUCH SWITCH OFF"/>		LED ACTION: <input type="text" value="CONCURRENTLY WITH GRIP SWITCH"/>		
HANDY GOT SETTING	END																				
GRIP SWITCH: <input type="text" value="USE"/>																					
PUSH BUTTON WRITE: <input type="text" value="DOES NOT WRITE"/>																					
SWITCH OFF ACTION: <input type="text" value="TOUCH SWITCH OFF"/>																					
LED ACTION: <input type="text" value="CONCURRENTLY WITH GRIP SWITCH"/>																					
HANDY GOT SETTING	END																				
GRIP SWITCH: <input type="text" value="USE"/>																					
PUSH BUTTON WRITE: <input type="text" value="DOES NOT WRITE"/>																					
SWITCH OFF ACTION: <input type="text" value="TOUCH SWITCH OFF"/>																					
LED ACTION: <input type="text" value="CONCURRENTLY WITH GRIP SWITCH"/>																					

- When the screen data is transferred from the screen creation software to the GOT-F900, the contents above are replaced with the contents set in the screen creation software. Have in mind that the setting about the grip switch is overwritten.

1	Introduction
2	Outline
3	Specifications
4	Installation and Wiring of F940GOT
5	Installation and Wiring of Handy GOT
6	Connection of Peripheral Equipment
7	Connection of Two or More GOT Units
8	Connection of MELSEC-F FX Series PLC
9	Connection of MELSEC-A Series PLC
10	Connection of MELSEC-QnA Series PLC

2) GT Designer2

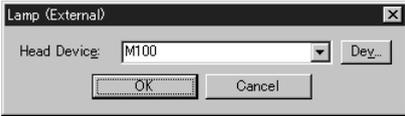
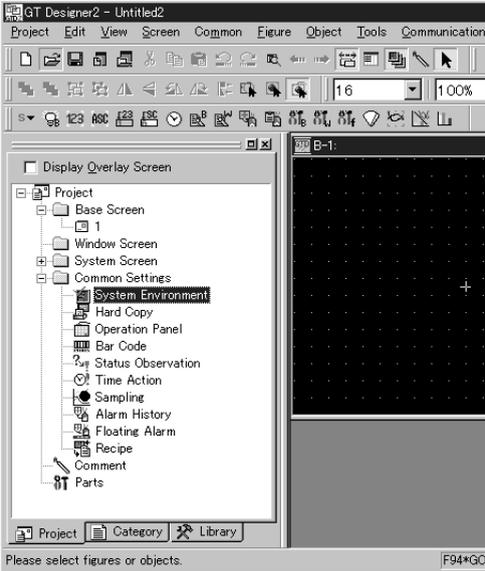
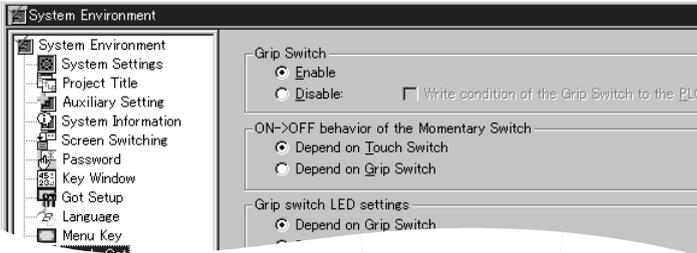
	Operation	Display (screen name)
<p>[Setting]</p>	<p>a) It is supposed that the GT Designer2 has started up and the screen data to be set is read.                      b) Open a user screen to be set.                      Any screen is available as far as it has been already created.                      Select and display the base screen (B-1) in this example.</p>	
<p>[LED setting] Operation switch</p>	<p>c) Select "Object"-&gt;"Lamp"-&gt;"External Lamp" on the menu.</p>  <p>d) On the "Lamp (External)" window, click the [Dev.] button, input a bit device to be assigned, then click [OK].                      Refer to Caution on setting of "Lamp (External)" described later.</p>	<p>The "Lamp" dialog box appears.</p>
<p>[Switch setting] Grip switch</p>	<p>e) On the menu, select "Common"-&gt;"System Environment" or double click "System Environment" in the folder "Common Settings" in the Project Workspace.</p>  <p>f) Click "Handy GOT" under "System Environment".                      Choose "Enable" for "Grip Switch".                      When using the grip switch function, set "Enable" to ON. When not using the grip switch function, set "Disable" to ON..</p> 	<p>The "System Environment" dialog box appears.</p>

Caution on setting of "Lamp (External)"

1. The object of "Lamp (External)" does not displayed on the screen.
2. The check box is valid only in the F930GOT-K and Handy GOT. Never set the check box in any other series.
3. Set only one lamp for all screens of the created screen data.

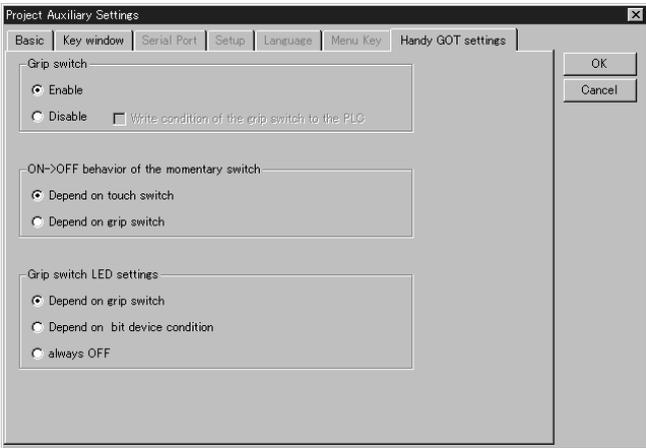

3) GT Designer

Operation		Display (screen name)
[Setting]	<p>a) It is supposed that the GT Designer has started up and the screen data to be set is read.</p> <p>b) Open a user screen to be set. (Any screen is available as far as it has been already created.) Refer to Caution on setting of "Lamp (External)" below.</p> <p>c) Select "Draw"-&gt;"Animation Display"-&gt;"Lamp" on the menu.</p>	<p>The "Lamp" dialog box appears.</p>
[LED setting] Operation switch	 <p>d) On the "Basic" tab, click "Lamp (External)" to give a check mark (✓), click the [Device] button, input a bit device to be assigned, then click [OK]. Refer to Caution on setting of "Lamp (External)" described later.</p>	
[Switch setting] Grip switch	<p>e) On the menu, select "Common"-&gt;"Auxiliary Setting"-&gt;"Project".</p> <p>f) The setting varies depending on the version of the screen creation software. &lt;When the GT Designer version is SW5-F (5.05F) or later&gt; Click the "Handy GOT settings" tab. When using the grip switch function, set "Enable" to ON. When not using the grip switch function, set "Disable" to ON.</p>	<p>The "Project Auxiliary Settings" dialog box appears.</p>
		

1	Introduction
2	Outline
3	Specifications
4	Installation and Wiring of F940GOT
5	Installation and Wiring of Handy GOT
6	Connection of Peripheral Equipment
7	Connection of Two or More GOT Units
8	Connection of MELSEC-FX Series PLC
9	Connection of MELSEC-A Series PLC
10	Connection of MELSEC-QnA Series PLC

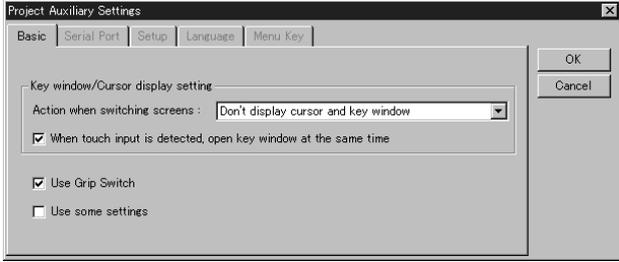
	Operation	Display (screen name)
	<p>&lt;When the GT Designer version is earlier than SW5-F (5.05F)&gt;                      Click the "Basic" tab.                      Click the check box of "Use Grip Switch" to give a check mark (✓).                      When using the grip switch function, give a check mark (✓).                      When not using the grip switch function, do not give a check mark (✓).</p> 	

Caution on setting of "Lamp (External)"

- 1.The contents of "Lamp (External)" you have set are not displayed on the screen.
- 2.The check box is valid only in the F930GOT-K and Handy GOT. Never set the check box in any other series.
- 3.Set only one lamp for all screens of the created screen data.

4) DU/WIN

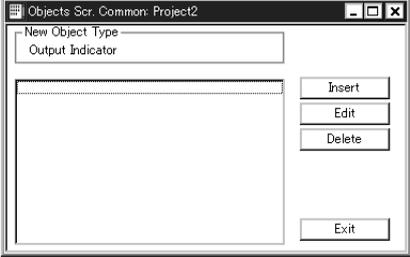
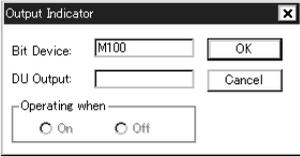
	Operation	Display (screen name)
[Setting]	<p>a) It is supposed that the DU/WIN has started and the screen data to be set has been read.</p> <p>b) Select "Common Screen" on the "Screen List" window (by clicking it to be highlighted).</p>  <p>If the window is closed, select "View/Project"-&gt;"Screen List" on the menu.</p>	<p>The "Screen List" window appears.</p>
[LED setting] Operation switch	<p>c) Click the [Objects] button.</p> <p>d) Select "Object"-&gt;"Indicator"-&gt;"Output Indicator" on the menu.</p>  <p>e) Click the [Insert] button.</p>  <p>Input a bit device to be assigned, and click [OK]. Refer to Caution on setting of "Output Indicator" below. Close all windows except the "Screen List" window.</p>	<p>The "Objects Scr. Common" window appears.</p> <p>"Output Indicator" is displayed in the "New Object Type" field on the "Objects Scr. Common" window.</p> <p>The "Output Indicator" dialog box appears.</p>

1	Introduction
2	Outline
3	Specifications
4	Installation and Wiring of F940GOT
5	Installation and Wiring of Handy GOT
6	Connection of Peripheral Equipment
7	Connection of Two or More GOT Units
8	Connection of MELSEC-F FX Series PLC
9	Connection of MELSEC-A Series PLC
10	Connection of MELSEC-QnA Series PLC

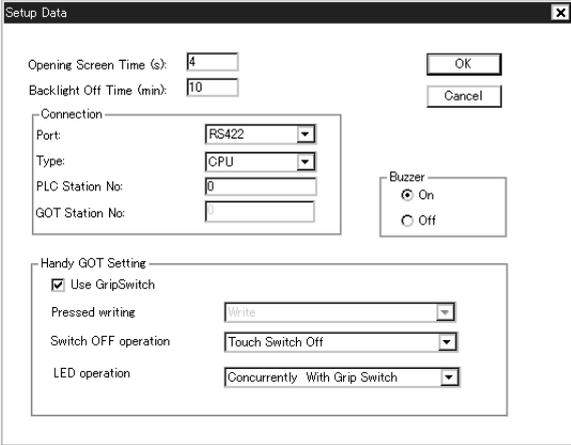
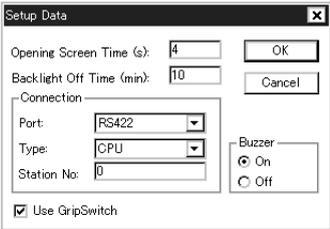
Operation		Display (screen name)
[Switch setting] Grip switch	<p>f) Select "View/Project"-&gt;"System Settings"-&gt;"Setup Data".</p> <p>g) The setting varies depending on the version of the screen software version.</p> <p>&lt;When the DU/WIN version is 2.50 or later&gt;</p>  <p>&lt;When the DU/WIN version is earlier than 2.50&gt;</p>  <p>h) Click "Use Grip Switch" to give a check mark (✓). When using the grip switch function, give a check mark (✓). When not using the grip switch function, do not give a check mark (✓).</p>	The "Setup Data" dialog box appears.

**Caution on setting of "Output Indicator"**

1. The contents of "Output Indicator" you have set are not displayed on the screen.
2. The setting of the "Output Indicator" check box is valid only in the F930GOT-K and Handy GOT. Never set it in any other series.
3. Set "Output Indicator" only on the common screen. Even if it is set on a user screen, it does not function.
4. Make sure that the bit device assigned on the "Output Indicator" dialog box is not included in the bit device range in set in "View/Project"->"System Settings"->"Interface Devices".

### 5.15 Connection Diagram of Handy GOT Operation Switches and Power Supply

This section explains the wiring method of the operation switches while picking up an example in which the operation switches are connected to inputs and outputs of the PLC.

#### 5.15.1 Cautions on preparing cables

When preparing the cables, use the wire size of 0.08mm<sup>2</sup> or more (AWG28 or more) for communication, 0.3mm<sup>2</sup> or more (AWG22 or more) for the power supply, operation switch, and emergency stop switch. Do not use a twisted pair cable for the power supply wire and the communication wire.

#### 5.15.2 The connection figure of cable

##### 1) Wiring between Handy GOT operation switches and connected equipment

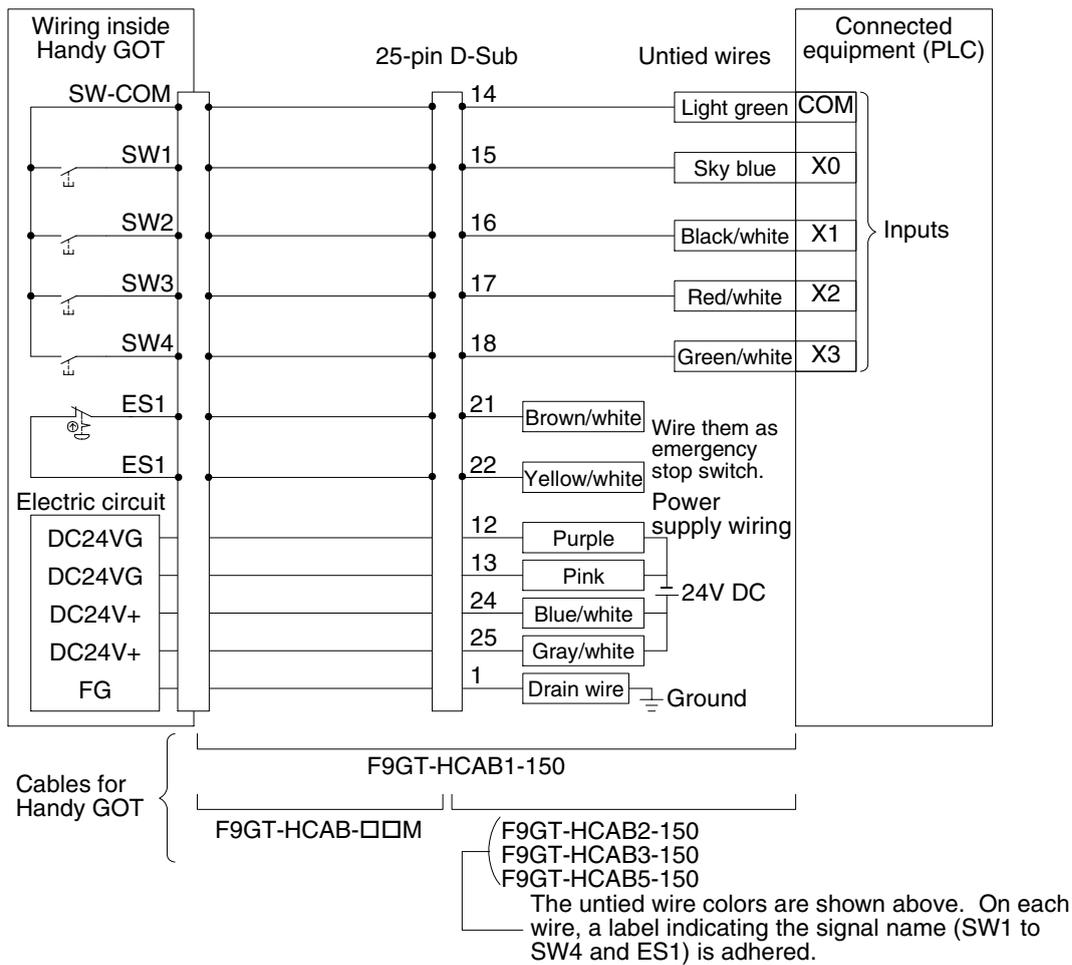

1	Introduction
2	Outline
3	Specifications
4	Installation and Wiring of F940GOT
5	Installation and Wiring of Handy GOT
6	Connection of Peripheral Equipment
7	Connection of Two or More GOT Units
8	Connection of MELSEC-FX Series PLC
9	Connection of MELSEC-A Series PLC
10	Connection of MELSEC-QnA Series PLC

2) Wiring between Handy GOT RH model operation switches and connected equipment

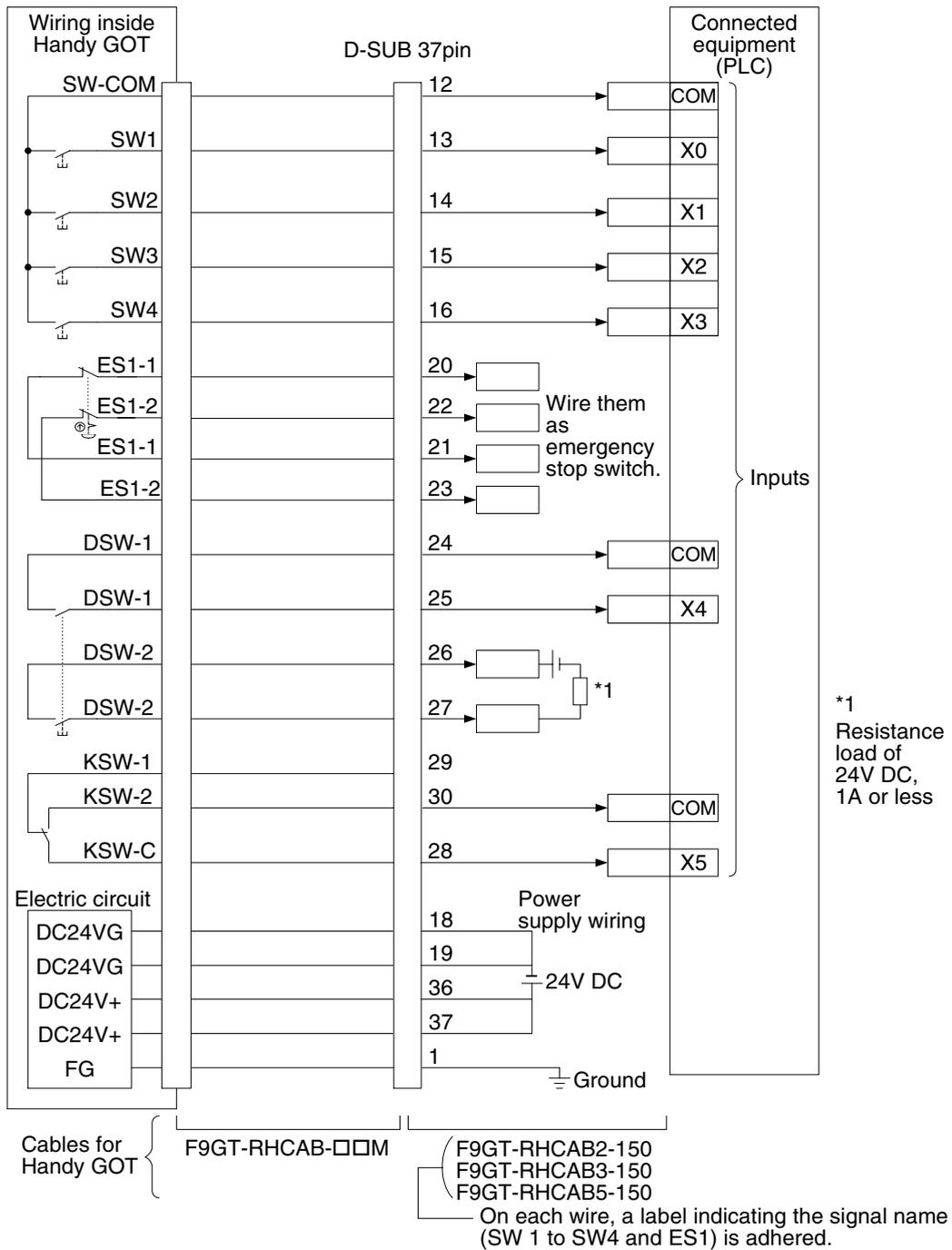

## 5.16 Connector Conversion Box F9GT-HCNB

### 5.16.1 Outline of Product

The connector conversion box F9GT-HCNB allows to use the Handy GOT (excluding the RH model) for RS-422 connection with attaching it or without attaching it on the panel face. In addition, the F9GT-HCNB functions as a relay box, and converts the 25-pin D-Sub connector of a connected external cable into a connector and terminal box for connecting the PLC, power supply and switches.

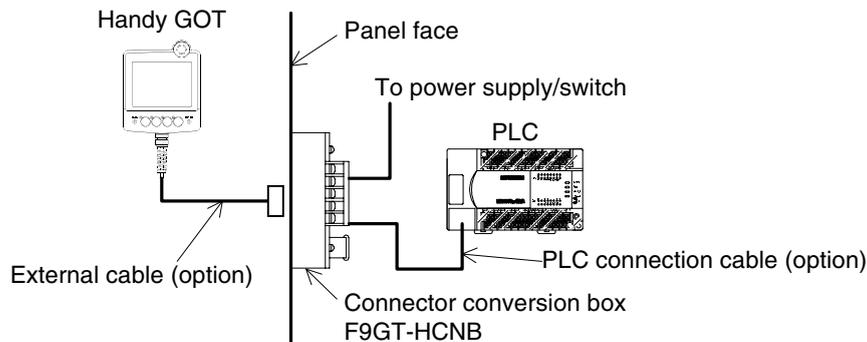

### 5.16.2 Name of Each Part

The figure below shows the name and function of each part of the connector conversion box.

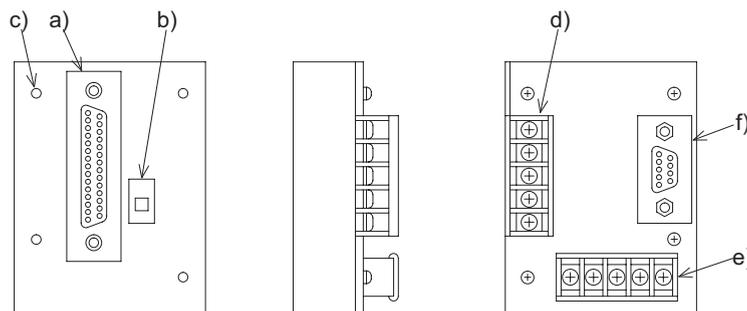

- Front face
  - a) Connector for Handy GOT (25-pin D-sub, female)  
Connects the Handy GOT with an external cable.
  - b) Power switch  
Supplies the power to the Handy GOT while it is ON.
  - c) Mounting hole (for M3 screw)  
Allows to fix the connector conversion box directly on the panel face or using a metal fixture.
- Rear face
  - d) Terminal block for operation switches  
Connects the operation switches SW1 to SW4 of the Handy GOT.
  - e) Terminal block for power supply and emergency stop switch  
Connects the power supply (24V DC) and emergency stop switch (ES1) of the Handy GOT.
  - f) Connector for PLC (9-pin D-sub, female)  
Connects the PLC with a cable.

5.16.3 Specifications

Outside dimensions

Unit: mm (inches)

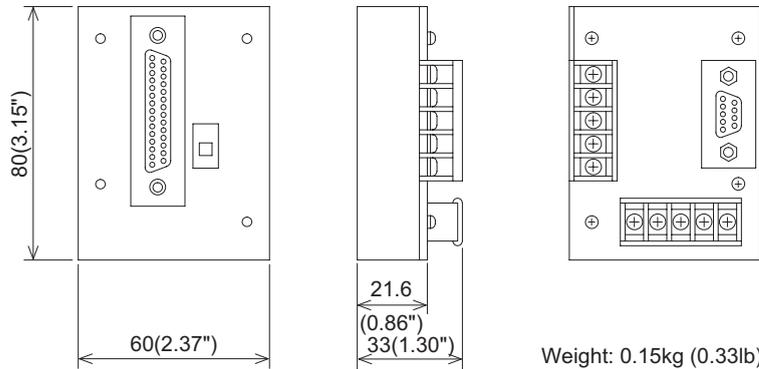

General specifications

Ambient operating temperature	0 to 55°C
Ambient operating humidity	35 to 85%RH Dew condensation shall not be allowed.
Vibration resistance	10 to 57 Hz, half amplitude: 0.035 mm, 57 to 150 Hz, acceleration: 4.9 m/s <sup>2</sup> , Number of times of sweep: 10 times in each of X, Y and Z directions (80 min in total)

Applicable GOT

Abbreviation		Model name	Availability
GOT-F900	F940 Handy GOT	F940GOT-SBD-H, F940GOT-LBD-H F940GOT-SBD-H-E, F940GOT-LBD-H-E	✓
	F943 Handy GOT	F943GOT-SBD-H, F943GOT-LBD-H	✗
	F940 Handy GOT RH model	F940GOT-SBD-RH, F940GOT-LBD-RH F940GOT-SBD-RH-E, F940GOT-LBD-RH-E	✗
	F943 Handy GOT RH model	F943GOT-SBD-RH, F943GOT-LBD-RH	✗
GOT-A900	A950 Handy GOT	A950GOT-SBD-M3-H, A950GOT-LBD-M3-H	✓
	A953 Handy GOT	A953GOT-SBD-M3-H, A953GOT-LBD-M3-H	✗



### 5.16.4 Installation

The connector conversion box can be installed directly on the panel face, or installed with a metal fixture offered as accessory.

#### Direct installation on the panel face

##### 1) Processing the panel face

Make an installation slot of the dimensions shown on the right on the panel face.

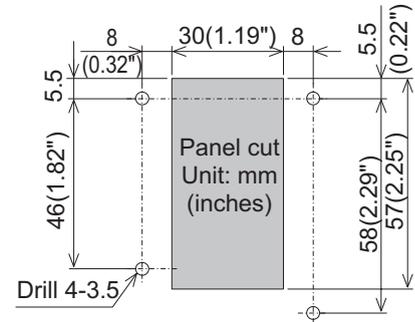

##### 2) Installing the connector conversion box on the panel face

Put the connector conversion box on the back side of the panel face, then fix it with M3 screws (prepared by the user) from the front side.

In mounting holes of the connector conversion box, thread of M3 × 7mm (0.28") in depth reprocessed.

While considering the plate thickness of the panel, prepare proper four mounting screws (M3).

Make sure that no interfering objects are present within 90mm (3.55") from the rear face so that the connector of the PLC cable can be easily connected.

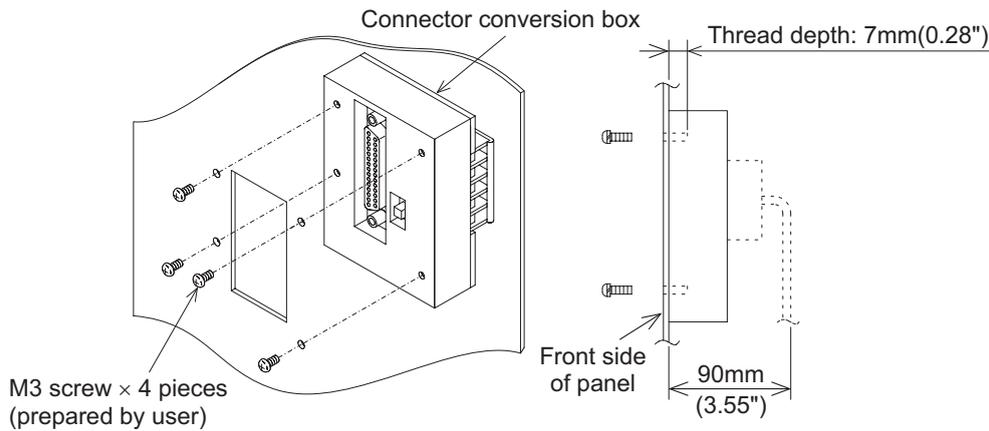

#### Installation with a metal fixture

##### 1) Attaching a metal fixture

Attach a metal fixture offered as an accessory to the connector conversion box.

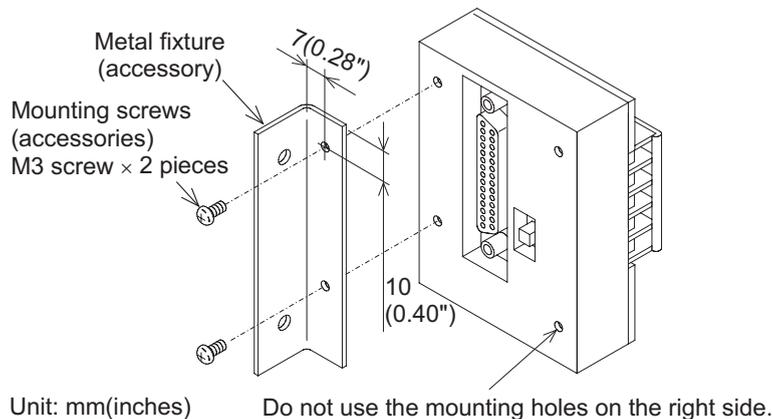

Unit: mm(inches)

Do not use the mounting holes on the right side.

1	Introduction
2	Outline
3	Specifications
4	Installation and Wiring of F940GOT
5	Installation and Wiring of Handy GOT
6	Connection of Peripheral Equipment
7	Connection of Two or More GOT Units
8	Connection of MELSEC-FX Series PLC
9	Connection of MELSEC-A Series PLC
10	Connection of MELSEC-QnA Series PLC

**2) Installing the connector conversion box on the panel face**

Install the connector conversion box on the panel face (mounting face).  
 On the panel face, make a mounting slot of the following dimensions.

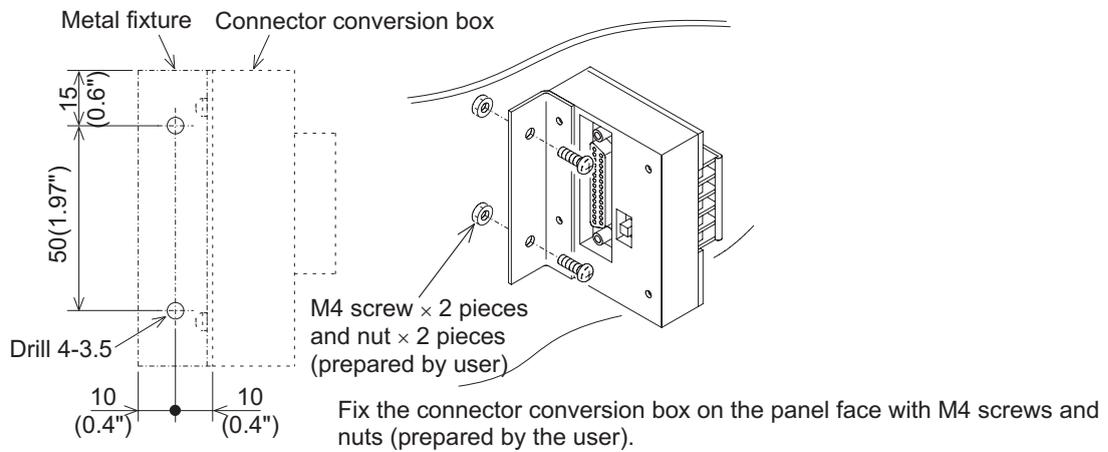

5.16.5 F9GT-HCNB Conversion Box

The 25-pin D-Sub connector of an external cable is converted into terminal blocks 2), 3) and a PLC port (9-pin D-Sub type).

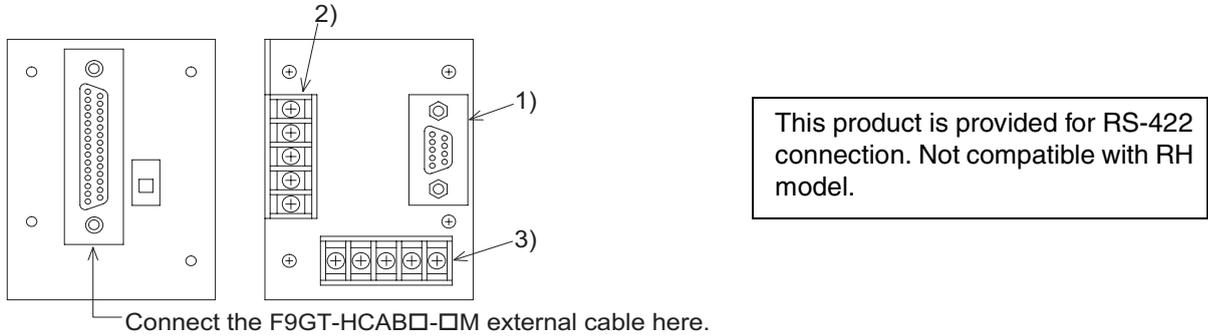

1) PLC port (9-pin D-Sub, female)

F9GT-HCNB	F9GT-HCAB-□M		Description
PLC port (9-pin D-Sub type)	Handy GOT connector		
	25-pin D-Sub	Signal name	
1	2	TXD+(SDA)	Signal wires for communication with PLC (For wiring, refer to the chapter corresponding to the connected PLC.)
2	6	RXD+(RDA)	
3	4	RTS+(RSA)	
4	8	CTS+(CSA)	
5	10	SG	
6	3	TXD-(SDB)	
7	7	RXD-(RDB)	
8	5	RTS-(RSB)	
9	9	CTS-(CSB)	
Shell	1	FG	Frame ground

2) Terminal block for operation switches

F9GT-HCNB	F9GT-HCAB-□M		Description
Terminal block for operation switches	Handy GOT connector		
	25-pin D-Sub	Signal name	
SWCOM	14	SW-COM (common)	For operation switches
SW1	15	SW1	
SW2	16	SW2	
SW3	17	SW3	
SW4	18	SW4	

3) Terminal block for power supply and emergency stop switch

F9GT-HCNB	F9GT-HCAB-□M		Description
Terminal block for power supply and emergency stop switch	Handy GOT connector		
	25-pin D-Sub	Signal name	
DC24V+	24,25	DC24V+	24V DC power supply of the main unit
DC24VG	12,13	DC24VG	
FG	1	FG	Frame ground
ES1	21	ES1	Emergency stop switch (Both ends of the contact of the switch are present here.)
ES1	22	ES1	

1 Introduction

2 Outline

3 Specifications

4 Installation and Wiring of F940GOT

5 Installation and Wiring of Handy GOT

6 Connection of Peripheral Equipment

7 Connection of Two or More GOT Units

8 Connection of MELSEC-FX Series PLC

9 Connection of MELSEC-A Series PLC

10 Connection of MELSEC-QnA Series PLC

### 5.17 Diagnostic

#### 5.17.1 F940 Handy GOT (F94\*GOT\*BD-H-E)

1) When an operation switch or emergency stop switch is disabled, check the following points.

- Check whether external cables are connected correctly to the Handy GOT.
- While pressing and holding an operation switch or emergency stop switch, check the conductivity between wires (pins or terminal blocks) of the external cables, relay cable and connector conversion box shown in the table below.

If the conductivity is not given, wire breakage or poor contact is present in the external cable or relay cable, or the circuits inside the Handy GOT may be damaged.

If it is suspected that the circuits inside the Handy GOT are damaged, consult with a Mitsubishi Electric distributor.

Switch name	Signals whose conductivity is checked				
	Signal name	External cable*1		External cable F9GT-HCAB-□M + Relay cable*2	External cable F9GT-HCAB-□M + Conversion box*3
		F9GT-HCAB-3M F9GT-HCAB-10M	F9GT-HCAB1-3M F9GT-HCAB1-10M	F9GT-HCAB2-150 F9GT-HCAB3-150 F9GT-HCAB5-150	F9GT-HCAB2-150 F9GT-HCAB3-150 F9GT-HCAB5-150
SW1	SW-COM and SW1	14 and 15	Light green and light blue	SW-COM and SW1	SWCOM and SW1
SW2	SW-COM and SW2	14 and 16	Light green and black/white	SW-COM and SW2	SWCOM and SW2
SW3	SW-COM and SW3	14 and 17	Light green and red/white	SW-COM and SW3	SWCOM and SW3
SW3	SW-COM and SW4	14 and 18	Light green and green/white	SW-COM and SW4	SWCOM and SW4
ES1	ES1 and ES1	21 and 22	Yellow/white and brown/white	ES1 and ES1	ES1 and ES1

\*1 Connect an external cable to the Handy GOT, press and hold each switch, then check the conductivity between pins or wires.

F9GT-HCAB-□M  
25-pin D-sub (male) connector

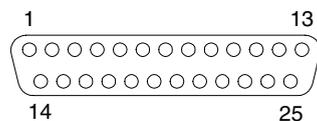

\*2 Connect an external cable and relay cable to the Handy GOT, press and hold each switch, then check the conductivity between each pair of wires of the relay cable.

\*3 Connect an external cable and connector conversion box F9GT-HCNB to the Handy GOT, press and held each switch, then check the conduction between the indicated pair of terminals in the conversion box. The conversion box is only used with F940GOT-SBD-H-E and F940GOT-LBD-H-E.

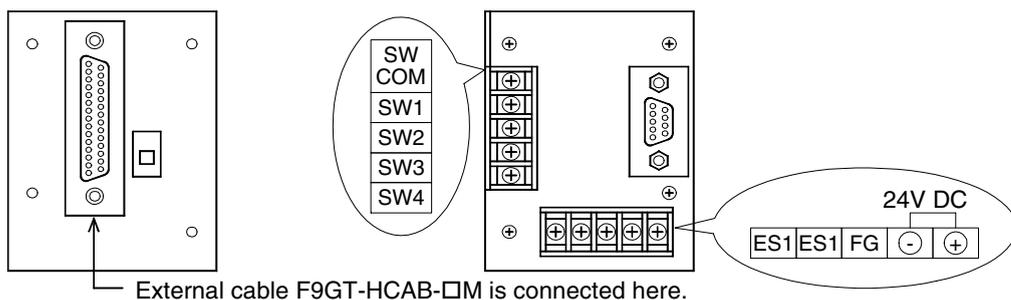

- 2) When using the Handy GOT in environment with much noise (when using a relay cable)

It is recommended to add a ferrite core to the communication cable area of the relay cable when using the Handy GOT in environment with much noise.  
Attach the ferrite core as shown below.

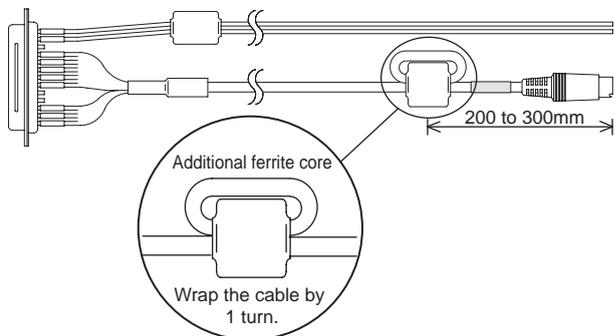

Ferrite core: Equivalent to ZCAT-3035-1330 (TDK)

1

Introduction

2

Outline

3

Specifications

4

Installation  
and Wiring of  
F940GOT

5

Installation  
and Wiring of  
Handy GOT

6

Connection of  
Peripheral  
Equipment

7

Connection of  
Two or More  
GOT Units

8

Connection of  
MELSEC-F FX  
Series PLC

9

Connection of  
MELSEC-A  
Series PLC

10

Connection of  
MELSEC-QnA  
Series PLC

5.17.2 F940GOT Handy (F94\*GOT\*BD-RH-E)

- 1) When an operation switch or emergency stop switch does not operate, check the following points.
- Check whether external cables are connected correctly to the Handy GOT. (Refer to chapter 3)
  - While pressing and holding an operation switch or emergency stop switch, check the conduction between wires (pins or terminal blocks) of the external cables and relay cable in the table below. If no conduction is confirmed, wire breakage or poor contact may be present in the external cable or relay cable, or the circuits inside the Handy GOT may be damaged. If it is suspected that the circuits inside the Handy GOT are damaged, consult with a Mitsubishi Electric distributor.

Switch name	Signals whose conductivity is checked			
	Signal name	External cable*1		External cable F9GT-RHCAB-□M + Relay cable*2 F9GT-RHCAB2-150 F9GT-RHCAB3-150 F9GT-RHCAB5-150
		F9GT-RHCAB-3M F9GT-RHCAB-10M	F9GT-RHCAB1-3M F9GT-RHCAB1-10M	
SW1	SW-COM and SW1	12 and 13	White/Red and Gray/Blue (B) <sup>*3</sup>	White/Red and Gray/Blue (B) <sup>*3</sup>
SW2	SW-COM and SW2	12 and 14	White/Red and Gray/Red (B) <sup>*3</sup>	White/Red and Gray/Red (B) <sup>*3</sup>
SW3	SW-COM and SW3	12 and 15	White/Red and Orange/Blue (B) <sup>*3</sup>	White/Red and Orange/Blue (B) <sup>*3</sup>
SW3	SW-COM and SW4	12 and 16	White/Red and Orange/Red (B) <sup>*3</sup>	White/Red and Orange/Red (B) <sup>*3</sup>
ES1-1	ES1-1 and ES1-1	20 and 21	Pink/Red and Pink/Blue (D) <sup>*3</sup>	Pink/Red and Pink/Blue (D) <sup>*3</sup>
ES1-2	ES1-2 and ES1-2	22 and 23	Orange/Red and Orange/Blue (D) <sup>*3</sup>	Orange/Red and Orange/Blue (D) <sup>*3</sup>
KSW-1	KSW-COM and KSW-1	28 and 29	White/Blue and Yellow/Red (B) <sup>*3</sup>	White/Blue and Yellow/Red (B) <sup>*3</sup>
KSW-2	KSW-COM and KSW-2	28 and 30	White/Blue and Yellow/Blue (B) <sup>*3</sup>	White/Blue and Yellow/Blue (B) <sup>*3</sup>

\*1 Connect an external cable to the Handy GOT, press and hold each switch, then check the conduction between pins or wires.

F9GT-RHCAB-□M  
37-pin D-sub, male connector

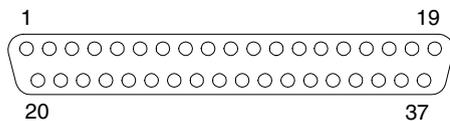

\*2 Connect an external cable and relay cable to the Handy GOT, press and hold each switch, then check the conduction between wires.

\*3 Arrangement of color type.

Arrangement of color (Color type)

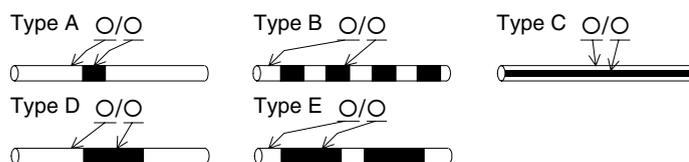

- 2) When using the Handy GOT in environment with much noise (when using a relay cable)  
It is recommended to add a ferrite core to the communication cable area of the relay cable when using the Handy GOT in environment with much noise.  
Attach the ferrite core as shown below.

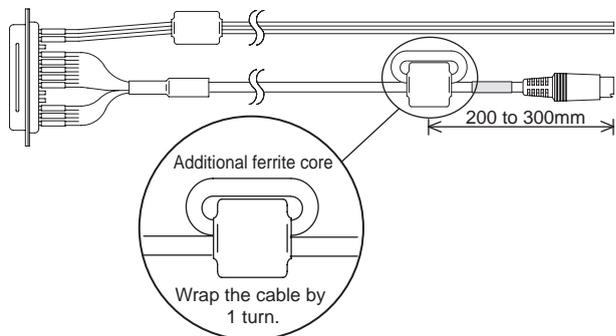

Ferrite core: Equivalent to ZCAT-3035-1330 (TDK)

1

Introduction

2

Outline

3

Specifications

4

Installation  
and Wiring of  
F940GOT

5

Installation  
and Wiring of  
Handy GOT

6

Connection of  
Peripheral  
Equipment

7

Connection of  
Two or More  
GOT Units

8

Connection of  
MELSEC-F FX  
Series PLC

9

Connection of  
MELSEC-A  
Series PLC

10

Connection of  
MELSEC-QnA  
Series PLC

### 5.18 How to Read Manual for Handy GOT RH Model

The cable diagram in the use of F94□ Handy GOT RH model is omitted hereafter. When using the Handy GOT RH model, read connection diagrams shown in the manual as shown below.

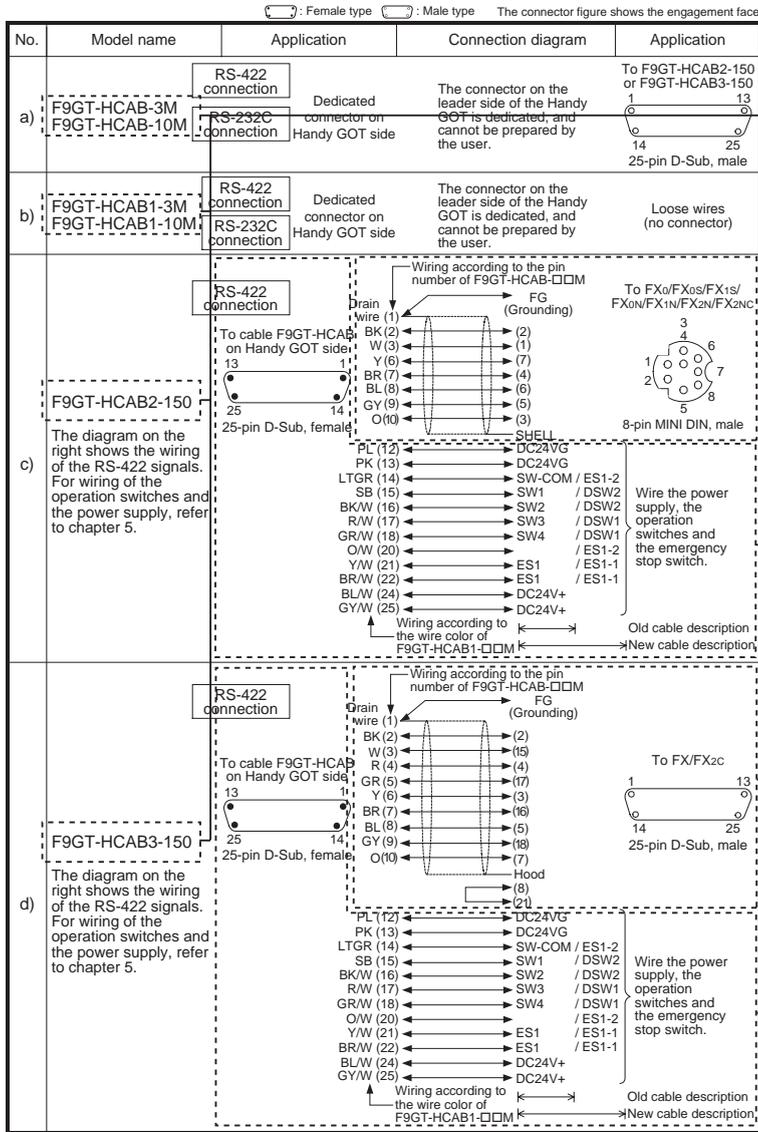

Read as shown in the tables below.

The wiring for serial communication is equivalent between the RS-422 and the RS-232C.

Understand as shown below.

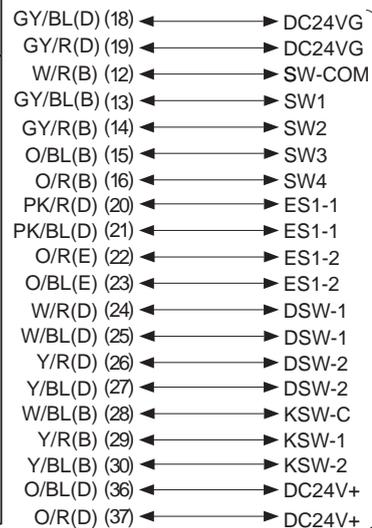
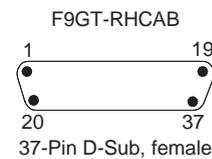

Wire the power supply, the operation switches and the emergency stop switch.

#### Handy GOT

Cable model name	Shape of cable end
F9GT-HCAB-3M F9GT-HCAB-10M	25-pin D-Sub (female)
F9GT-HCAB1-3M F9GT-HCAB1-10M	Untied
F9GT-HCAB2-150	8-pin MINI DIN
F9GT-HCAB3-150	25-pin D-Sub
F9GT-HCAB5-150	6-pin MINI DIN

#### Handy GOT RH model

Cable model name	Shape of cable end
F9GT-RHCAB-3M F9GT-RHCAB-6M F9GT-RHCAB-10M	37-pin D-Sub
F9GT-RHCAB1-3M F9GT-RHCAB1-10M	Untied
F9GT-RHCAB2-150	8-pin MINI DIN
F9GT-RHCAB3-150	25-pin D-Sub
F9GT-RHCAB5-150	6-pin MINI DIN



## 6. Connection of Peripheral Equipment (Screen data transfer/Sequence program transfer and monitor)

This chapter explains connection between the GOT-F900 and peripheral equipment.

### 6.1 Outline of Connection

The GOT-F900 and the peripheral equipment are connected as follows in accordance with each purpose. When a personal computer is connected, screen data transfer and sequence program transfer are executed in the same cable configuration.

The dedicated programming tool for the PLC is connected using the FX-2PIF.

#### Screen Creation

##### 1) GOT ↔ Personal computer (screen creation software)

Refer to 6.2.1.

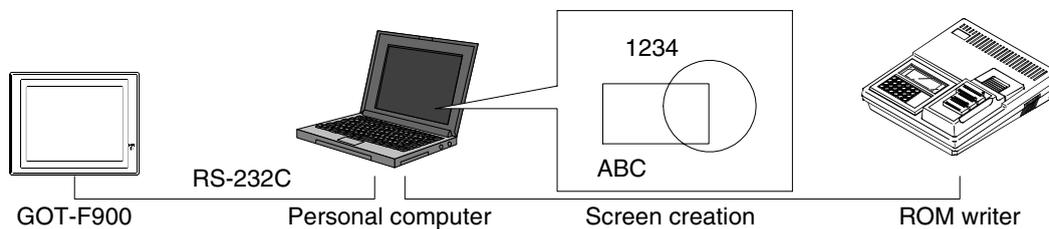

Connection when screen data transfer and OS transfer are executed between the GOT-F900 and the screen creation software installed in the personal computer

##### 2) F943 Handy GOT (PLC connector) ↔ Personal computer (screen creation software)

Refer to 6.3.

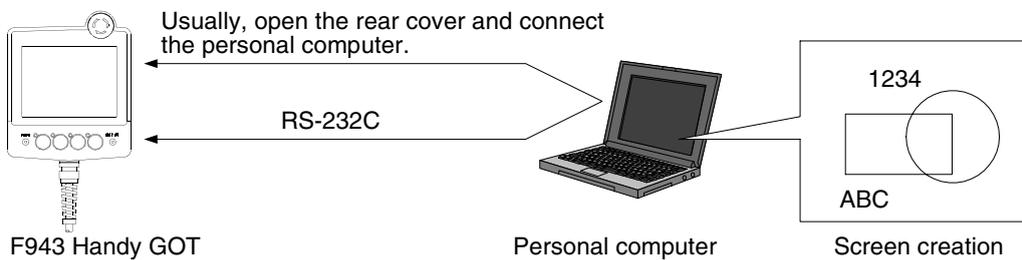

Connection when screen data transfer is executed while a personal computer is connected to the PLC port (RS-connected to the PLC port (RS-232C) of the F943 Handy GOT (This function is available only in the Handy GOT whose OS version is 6.00 or later.)

#### Sequence Program

##### 3) GOT ↔ Personal computer (sequence programming software)

Refer to 6.2.2.

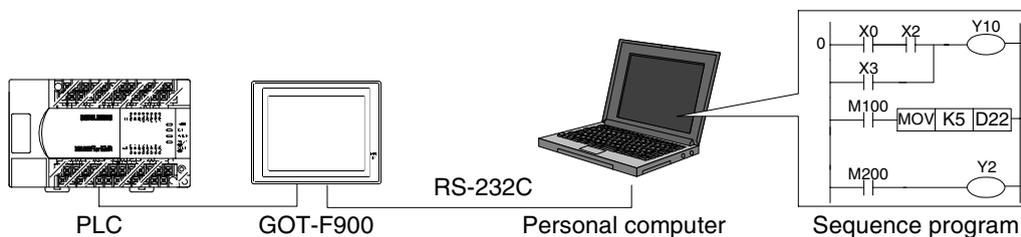

Connection when sequence program transfer and monitoring are executed through the two-port interface built in the GOT-F900 between the PLC and the personal computer (Such operations can be performed while manipulating and displaying screens in the GOT-F900.)

4) GOT ↔ FX-2PIF ↔ A6GPP/A7PHP/HPP

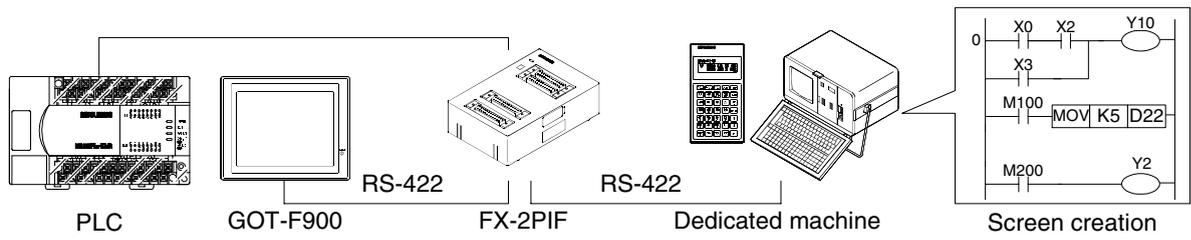

Connection when sequence program transfer and monitoring are executed while the GOT-F900 and the dedicated programming tool for PLC are connected to the FX Series and A Series PLC through the FX-2PIF. (Excluding the F920GOT-K and Handy GOT)

## 6.2 Connection to Personal Computer

This section explains the configuration when the created screen data and sequence programs (using the built-in two-port interface function) are transferred while a personal computer is connected to the RS-232C port of the GOT-F900.

### 6.2.1 Screen Data Transfer

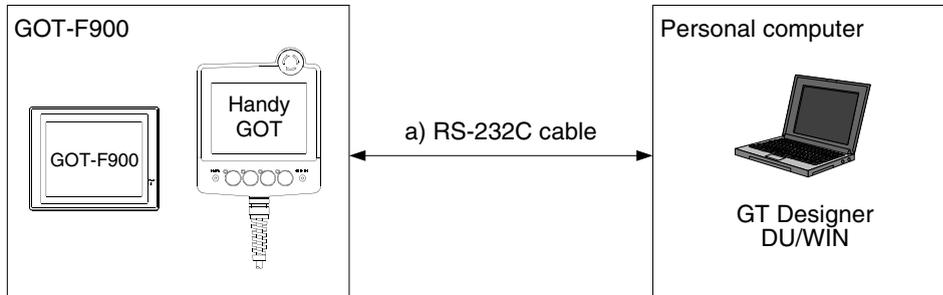

#### 1) Data transfer cable

a) RS-232C cable	Personal computer	RS-232C port shape of personal computer
FX-232CAB-1	PC/AT compatible machine	9-pin D-Sub, male

- The screen data and sequence program can be transferred using a same cable.

#### Caution on use of 5 V type F920GOT-K

The F920GOT-K (excluding the 24V type) and the Q Series PLC (CPU direct connection) are connected via RS-232C ports. Therefore, a power cable needs to be prepared separately by the user when transferring screen data.

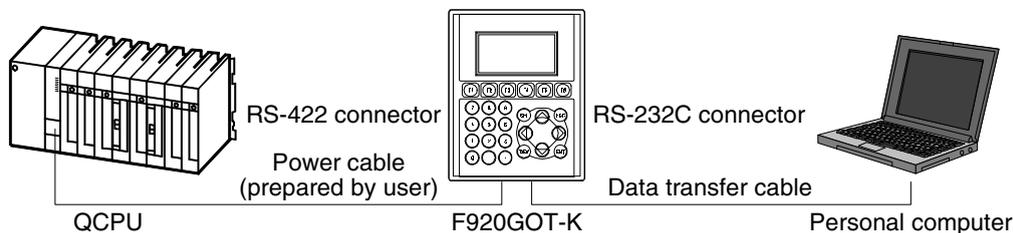

- Select a cable for connecting personal computers from the table above.
- The cable to connect QCPU units should be prepared by the user in reference to Cable Diagram in Chapter 11.
- For details, refer to Caution on Use of Peripheral Equipment described later.

**6.2.2 Sequence Program Transfer (two-port interface function built)**

Sequence program transfer and monitoring can be executed through the two-port interface function built in the GOT-F900.

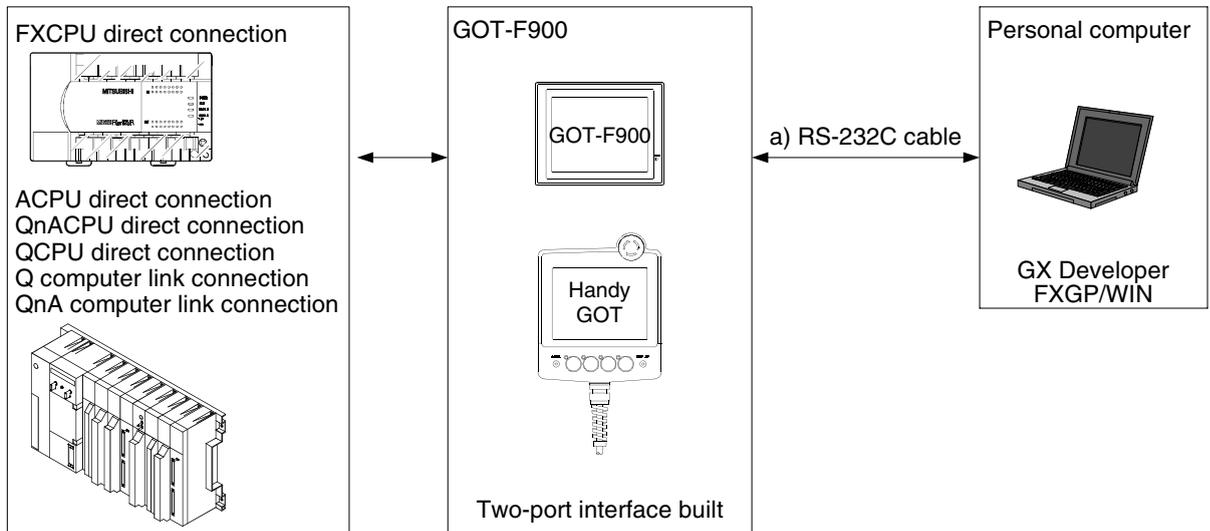

The F920GOT-K can be used only in the FXCPU direct connection.

**1) Applicable PLC**

Transferred data type		Applicable PLC	
Sequence program transfer	F920GOT-K	FXCPU direct connection (RS-422 connection only)	
	Other than F920GOT-K	FXCPU direct connection QnACPU direct connection Q computer link connection	ACPU direct connection QCPU direct connection QnA computer link connection

**2) Data transfer cable**

a) RS-232C cable	Personal computer	RS-232C port shape of personal computer
FX-232CAB-1	PC/AT compatible machine	9-pin D-Sub, male

- The screen data and sequence program can be transferred using a same cable.

### 6.2.3 Cable Connection Procedure

This section explains the procedure to connect the GOT and a personal computer with a cable.

**1. Connecting the cable to the personal computer**

Connect one side of the data transfer cable to the RS-232C interface port of the personal computer. (Select a proper data transfer cable in accordance with the port shape of the personal computer.)

**2. Connecting the cable to the GOT**

The port used varies depending on the GOT model as follows.

**1) F920GOT-K**

Connect the other side of the data transfer cable to the RS-232C port located in the right position seen from the rear face of the unit (figure on the right).

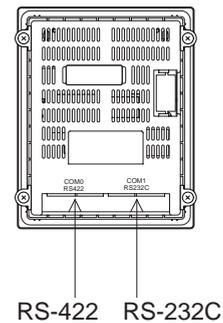

**2) F930GOT**

Connect the other side of the data transfer cable to the RS-232C port located in the right position seen from the rear face of the unit (figure on the right).

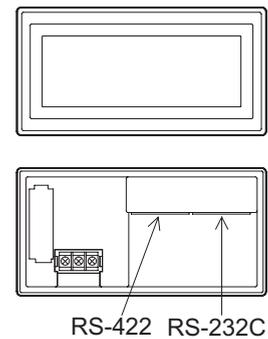

**3) F930GOT-K**

Connect the other side of the data transfer cable to the RS-232C port located in the left position seen from the rear face of the unit (figure on the right).

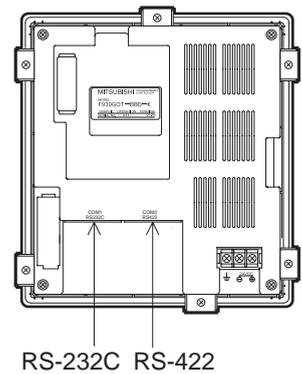

**4) F940GOT**

Connect the other side of the data transfer cable to the RS-232C port located in the upper position seen from the right side of the unit (figure on the right).

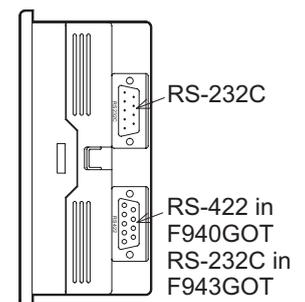

1	Introduction
2	Outline
3	Specifications
4	Installation and Wiring of F940GOT
5	Installation and Wiring of Handy GOT
6	Connection of Peripheral Equipment
7	Connection of Two or More GOT Units
8	Connection of MELSEC-F FX Series PLC
9	Connection of MELSEC-A Series PLC
10	Connection of MELSEC-QnA Series PLC

**5) F940WGOT**

Connect the other side of the data transfer cable to the RS-232C port (b) located in the upper position seen from the right side of the unit. The RS-232C port (a) is offered for the PLC. It is not available for a personal computer.

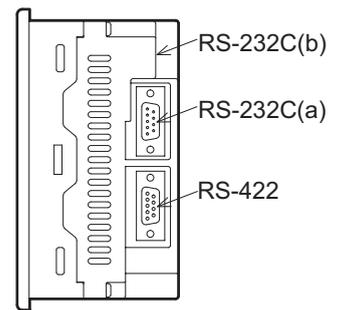
**6) Handy GOT**

The rear cover removal method is roughly explained below.

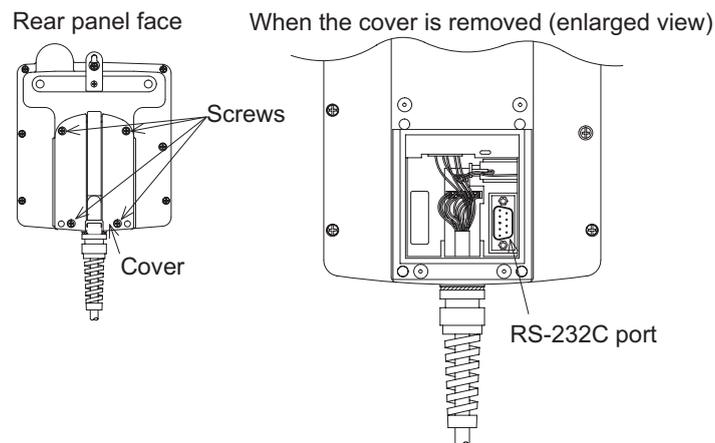

- a) Remove the four mounting screws.
- b) Open the rear cover.
- c) Connect the other end of the data transfer cable to the 9-pin D-Sub (RS-232C) port.

### 6.3 Connection of F943 Handy GOT (for PLC) and Personal Computer

This section explains how to transfer the screen data from the F943 handy GOT without opening the rear cover.

#### 6.3.1 Outline

When PLC is connected

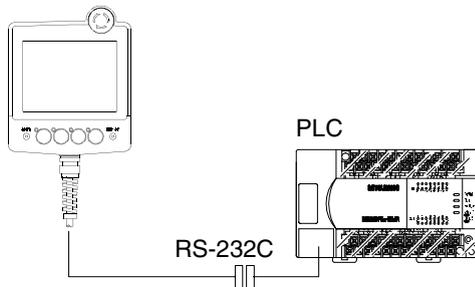

When screen data is transferred

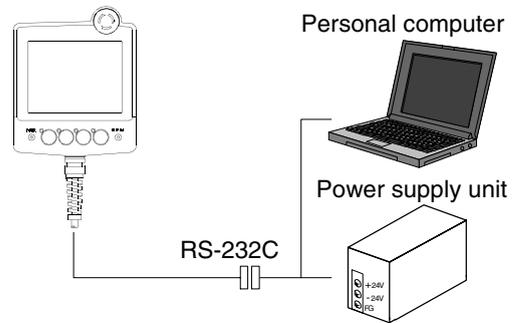

When the personal computer is connected to the cable (with an RS-232C connector for PLC) connecting the PLC using a cable shown below, screen data can be transferred between the F943 Handy GOT and the personal computer.

#### OS version compatible with the F943 Handy GOT

The F943 Handy GOT is compatible with Ver. 6.00 or later.

If the OS version is former than Ver. 6.00, remove the rear cover of the F943 Handy GOT, then connect the personal computer to the connector for PC. (Refer to 6.2.)

#### 6.3.2 Configuration to transfer screen data using PLC connector

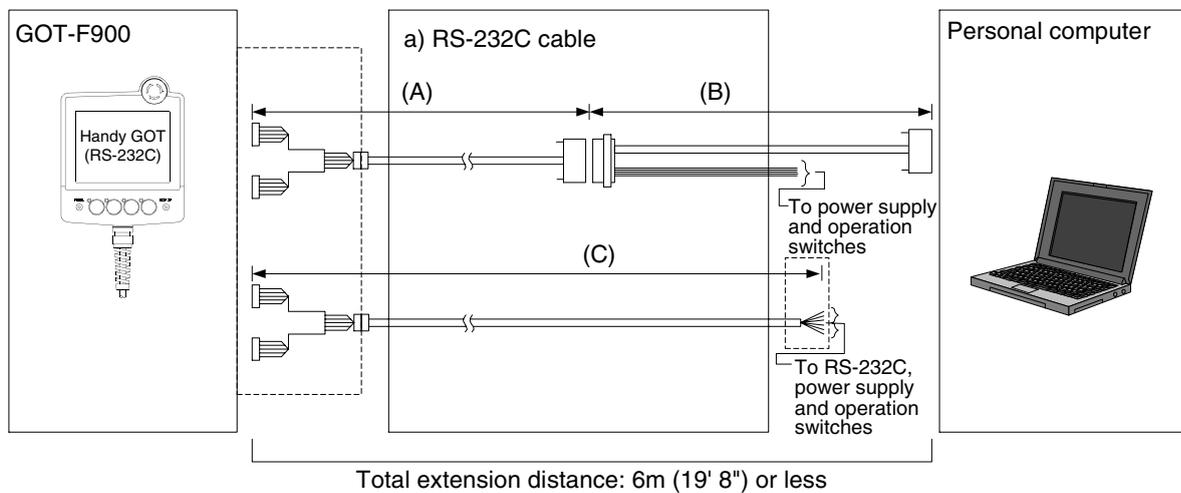

#### 1) Data transfer cable

a) RS-232C cable	Personal computer	Port shape
(A)F9GT-HCAB-□□M (B)Prepared by user (C)F9GT-HCAB1-□□M	PC/AT compatible machine (DOS/V)	9-pin D-Sub, female

- As to the (C)F9GT-HCAB1-□□M, the user should attach an intermediate connector, and prepare a cable for PLC and a cable for personal computer.

1	Introduction
2	Outline
3	Specifications
4	Installation of F940GOT
5	Installation and Wiring of Handy GOT
6	Connection of Peripheral Equipment
7	Connection of Two or More GOT Units
8	Connection of MELSEC-FX Series PLC
9	Connection of MELSEC-A Series PLC
10	Connection of MELSEC-QnA Series PLC

### 6.3.3 Changeover of Connection between PLC and Personal Computer

For connecting a personal computer, the status of the PLC port of the F943 Handy GOT should be changed over from PLC connection to personal computer connection (screen data transfer) by the screen operation. The operations of the Handy GOT are explained below.

#### 1) Startup operation

<When the OS version is 6.00 or later>

When the SELECT MODE screen change operation is disabled.

Operation	Display (screen name)
a) While pressing and holding the upper left corner of the screen, turn on the power. Keep holding the upper left corner for about 25 seconds more. Then, press "END" at the upper right corner.	The "LANGUAGE" screen appears.
b) Press "END" at the upper right corner.	The "SET-UP MODE" screen appears.
c) Press "OTHER MODE" on the menu.	The "SELECT MODE" screen appears.
d) Press "OTHER MODE" on the menu.	The "OTHER MODE" screen appears.
d) Press "DATA TRANSFER" on the menu.	The "DATA TRANSFER" screen appears.

When the main SELECT MODE change operation is enabled.

Operation	Display (screen name)
a) Press the upper left corner of the screen. (The position to be pressed can be changed in the GOT and the screen creation software.)	The "SELECT MODE" screen appears.
b) Press "OTHER MODE" on the menu.	The "OTHER MODE" screen appears.
c) Press "DATA TRANSFER" on the menu.	The "DATA TRANSFER" screen appears.

#### 2) Screen operation

When the "DATA TRANSFER" screen shown below appears, set "PORT" to "EXTERNAL PORT" by touching the screen.

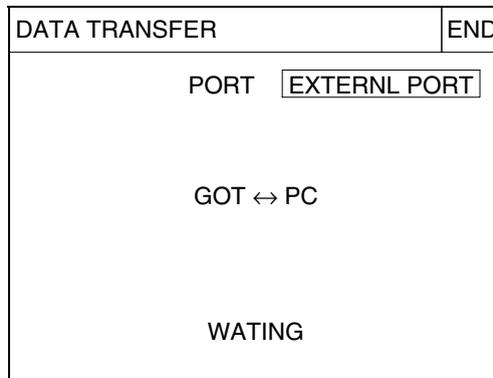

PORT	EXTERNL PORT	Specifies the PLC connector.
	INTERNAL PORT	Specifies the personal computer port (RS-232C) provided on the rear face.

When changing over the screen to a user screen after having transferred the screen data, "INTERNAL PORT" is automatically specified and communication with the PLC is enabled.

#### 3) Caution on use

Though "PORT" is displayed also in the F940 Handy GOT, it is invalid because only RS-422 connection is available.



## 6.4 Caution on Use of Peripheral Equipment

When connecting a personal computer to the GOT in order to transfer screen data or sequence program or to monitor the personal computer, observe the following cautions on use.

### 6.4.1 Caution when connecting the GOT and PLC via RS-232C port (Only in case of the F920GOT-K, F930GOT, F930GOT-K, or F940GOT)

If the GOT-F900 (which is equipped with one RS-422 port and one RS-232C port) has already been set to connect with the PLC using the RS-232C port, the data transfer screen is not displayed automatically even when a personal computer is connected to the RS-232C port instead of the PLC (due to the RS-232C port priority).

To eliminate the inconvenience described below, it is recommended to use the GOT-F900 with two RS-232C ports. (Available only in certain models)

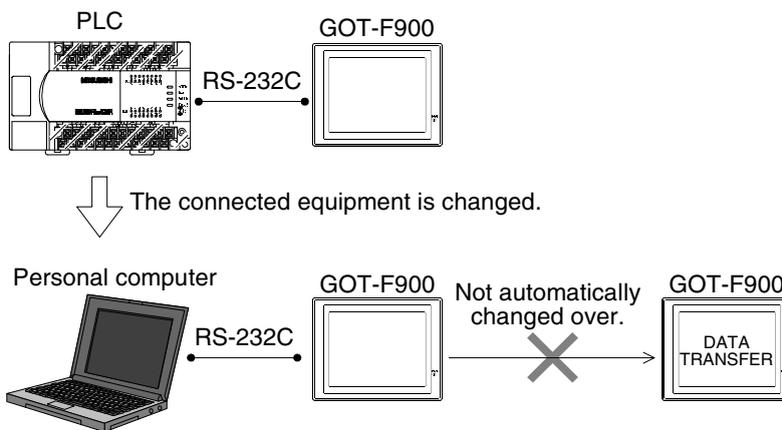

Follow the procedures below and changeover the screen manually from SELECT MODE to DATA TRANSFER in order to transfer screen data.

#### Operating procedures

- 1) While pressing and holding the upper left corner of the screen, turn on the power. Keep holding for a while.
- 2) The "LANGUAGE" screen appears. Press "END".
- 3) The "SET-UP MODE" screen appears. Press "END".
- 4) The "SELECT MODE" screen appears. Press "OTHER MODE".
- 5) The "OTHER MODE" screen appears. Press "DATA TRANSFER".
- 6) Transfer screen data.

#### RS-232C port function priority

The setting for the function with higher priority is confirmed first. If the function has been set, the one with lower priority is not executed.

For example, if a connected equipment (PLC) or bar code reader is set valid, screen data transfer or sequence program transfer and monitor is not enabled because those functions have lower priority as shown in the table.

Rank order	RS-232C functions
1	Connected equipment (PLC, general-purpose equipment)
2	Bar code reader
3	Printer
4	2-port interface function *1
5	Screen data transfer mode

\*1 Available only in the FX, A, or QnA, Q Series CPU direct connection (including the QnA or Q serial communication).

However, when using the F920GOT-K, available only in the FX Series CPU direct connection.

1	Introduction
2	Outline
3	Specifications
4	Installation and Wiring of F940GOT
5	Installation and Wiring of Handy GOT
6	Connection of Peripheral Equipment
7	Connection of Two or More GOT Units
8	Connection of MELSEC-F FX Series PLC
9	Connection of MELSEC-A Series PLC
10	Connection of MELSEC-QnA Series PLC

## 6.4.2 Caution when transferring screen data to the F920GOT-K (5V type)



### Caution on Start-up

- Never connect any cable other than a screen data transfer cable to the RS-232C port on the F920GOT-K when transferring screen data. Otherwise, it may cause critical damage to the F920GOT-K or connected equipment such as a PLC and personal computer.
- Do not connect the PLCs to the RS-232C port and RS-422 port on the F920GOT-K at the same time. Otherwise, consequential effect or damage may be caused to the F920GOT-K or PLCs.

When transferring screen data, the F920GOT-K (5 V type) needs to be connected to the PLC in the power ON status in order to supply power to the F920GOT-K (5 V type). (Connect the F920GOT-K (24 V type) with a cable used also for the F930GOT and F940GOT.)

#### 1) In the case of the FX/A/QnA Series PLC CPU direct connection

Connect the PLC to the RS-422 port.

When connecting the FX/A/QnA Series PLC, use the applicable RS-422 cables shown in the cable diagrams in Chapter 8, 9, and 10 respectively.

A personal computer is to be connected to the RS-232C port via a screen data transfer cable.

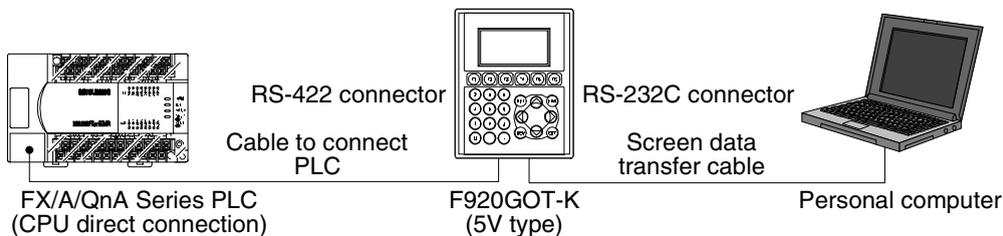

#### 2) In the case of the Q Series PLC CPU direct connection

In order to execute data transfer between a personal computer and the GOT, they should be connected by a screen data transfer cable via RS-232C ports following the procedure below.

First, disconnect the data transfer cable between the Q Series PLC and the GOT. Second, connect the data transfer cable. Third, connect the PLC and the RS-422 port on the F920GOT-K using the power cable which is prepared by the user in reference to the cable diagram in Chapter 11. Then execute data transfer using the screen data transfer cable.

##### a) When transferring screen data

- Turn off the PLC.
- Connect the RS-232C port on the GOT and the personal computer using the data transfer cable.
- Connect the power cable to the RS-422 port.

Execute the transfer after selecting DATA TRANSFER on a system screen.

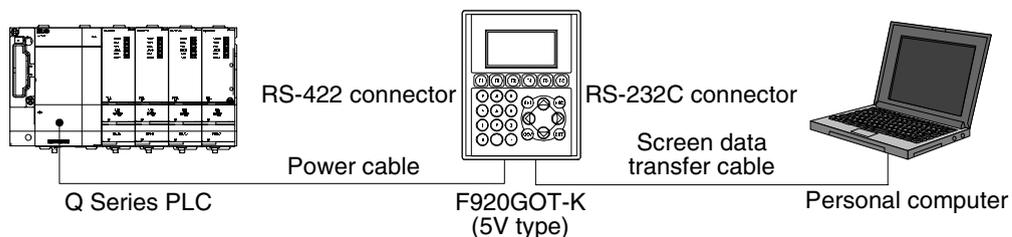

Once screen data transfer is finished, make sure to turn off the PLC and disconnect the power cable before connecting the Q Series PLC to the RS-232C port of the GOT. Otherwise, it may cause critical damage to the connected equipment such as the F920GOT-K, PLC, or personal computer.

b) When connecting to the PLC

- Turn off the PLC.
- Disconnect the power cable used for screen data transfer.
- Connect a cable between the RS-232C ports of the F920GOT-K and QCPU.

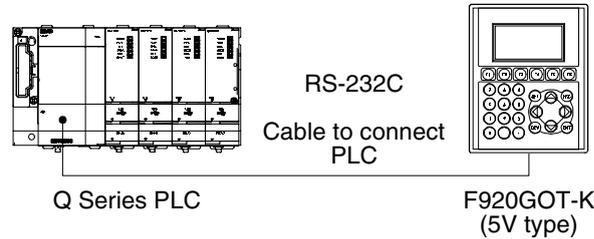

### 6.4.3 Cautions on connection to FX3U/FX3UC Series PLC

When monitoring circuits, device registration, etc. in an FX3U or FX3UC PLC from GX Developer Ver. 8.13P or later using the transparent (2-port) function in the GOT-F900 Series, make sure to execute the following settings.

If the following setting is not provided, monitoring cannot be normally executed.

	GX Developer Ver.8.12N or earlier*1	GX Developer Ver.8.13P or later	GX Developer Ver.8.22Y or later
When using 2-port interface function in GOT-F900 Series	Setting shown below is not required. (Setting is not available.)	Setting shown below is required.	Select "RS-232C" on "PC side I/F Serial setting" dialog box, and execute settings shown below.

\*1. GX Developer Ver.8.13P or later supports the FX3UC Series.

#### Setting in GX Developer (Ver.8.13P or later)

1. Select [Online] → [Transfer setup...] to open "Transfer Setup" dialog box.
2. Double-click [PLC module] in [PLC side I/F] to open [PLC side I/F Detailed setting of PLC module] dialog box.
3. Put a check mark in the check box [via GOT-F900 transparent mode] as shown below.

4. Click [OK] button to finish the setting.

1	Introduction
2	Outline
3	Specifications
4	Installation and Wiring of F940GOT
5	Installation and Wiring of Handy GOT
6	Connection of Peripheral Equipment
7	Connection of Two or More GOT Units
8	Connection of MELSEC-F FX Series PLC
9	Connection of MELSEC-A Series PLC
10	Connection of MELSEC-QnA Series PLC

## 6.5 Cable Diagram

This section explains the cable diagram when the GOT-F900 is connected to a personal computer.

### 6.5.1 Cautions on preparing cables

When preparing the cables, use the wire size of 0.08mm<sup>2</sup> or more (AWG28 or more) for communication, 0.3mm<sup>2</sup> or more (AWG22 or more) for the power supply, operation switch, and emergency stop switch. Do not use a twisted pair cable with the power supply wire and the communication wire.

### 6.5.2 Cable for Personal Computer

#### 1) Cable for the GOT and a personal computer

 : Female type   
  : Male type   
 The connector figure shows the engagement face.

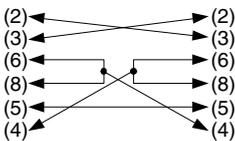
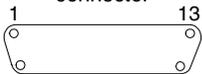
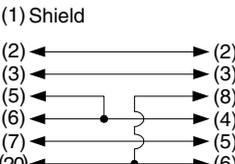
No.	Model name	Application	Connection diagram	Application
a)	FX-232CAB-1	RS-232C connection To personal computer connector  9-pin D-Sub, female		To GOT-F900  9-pin D-Sub, female
b)	F2-232CAB-1	RS-232C connection To personal computer connector  25-pin D-Sub, male		To GOT-F900  9-pin D-Sub, female

#### 2) Cable the F943 Handy GOT and a personal computer (through the PLC connector)

 : Female type   
  : Male type   
 The connector figure shows the engagement face.

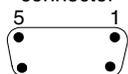
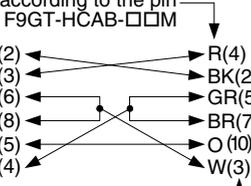
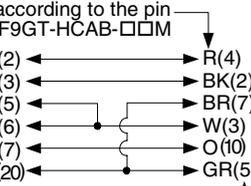
No.	Model name	Application	Connection diagram	Application
c)	Prepared by user	RS-232C connection To personal computer connector  9-pin D-Sub, female		To cable F9GT-HCAB/F9GT-HCAB1 on Handy GOT side
d)	Prepared by user	RS-232C connection To personal computer connector  25-pin D-Sub, male		To cable F9GT-HCAB/F9GT-HCAB1 on Handy GOT side

## 6.6 Troubleshooting

For reference, this section summarizes frequently asked questions about connection of the GOT-F900 to a personal computer.

### 1) GOT-F900

Classification	Contents of trouble	Check points and countermeasures
GT Designer DU/WIN	When the screen data is transferred by the screen creation software, "No response from terminal", etc. is displayed.	The RS-232C port of the GOT-F900 is used by another connected equipment (bar code reader or printer). <ul style="list-style-type: none"> <li>• Causes                             <ol style="list-style-type: none"> <li>1)"RS-232C" is specified for PLC connection.</li> <li>2)The bar code reader is set valid.</li> <li>3)The printer is set valid.</li> </ol>                             Confirm the settings above in the screen creation software.                         </li> <li>• Countermeasures                             <p>Select by hand the data transfer mode in the GOT-F900. Start up the system screen, display the "SELECT MODE" screen, select "OTHER MODE" - "DATA TRANSFER" on the menu, then transfer the screen data.</p> </li> </ul>
GOT-F900	When the screen data is transferred by the screen creation software, the "DATA TRANSFER" screen does not appear in the GOT-F900.	

- 1  
Introduction
- 2  
Outline
- 3  
Specifications
- 4  
Installation and Wiring of F940GOT
- 5  
Installation and Wiring of Handy GOT
- 6  
Connection of Peripheral Equipment
- 7  
Connection of Two or More GOT Units
- 8  
Connection of MELSEC-F FX Series PLC
- 9  
Connection of MELSEC-A Series PLC
- 10  
Connection of MELSEC-QnA Series PLC

2) Program

Classification	Contents of trouble	Check points and countermeasures
<p>GX Developer, FXGP/WIN or dedicated machine</p>	<p>Sequence program transfer/ monitoring is disabled.</p>	<p>The RS-232C port of the GOT-F900 is allocated to another connected equipment (bar code reader printer).</p> <ul style="list-style-type: none"> <li>• Causes                             <ol style="list-style-type: none"> <li>1)"RS-232C" is specified for PLC connection.</li> <li>2)The bar code reader is set valid.</li> <li>3)The printer is set valid.</li> </ol>                             Confirm the settings above in the screen creation software.                         </li> <li>• Countermeasures                             <p>Against 1), set PLC connection to RS-422. Or select a model equipped with two built-in RS-232C ports (such as the F943GOT-SBD-H).</p> <p>Against 2) and 3), Change the setting in the screen creation software.</p> </li> </ul> <hr/> <p>The sequence programming tool (dedicated machine) is connected to the RS-422 port of the GOT-F900.</p> <ul style="list-style-type: none"> <li>• Cause                             <p>The sequence programming tool (dedicated machine) cannot be connected to the RS-422 port of the GOT-F900.</p> </li> <li>• Countermeasures                             <p>Only a personal computer can be connected to the RS-232C port. (The dedicated machine can be connected using the two-port interface FX-2PIF.)</p> </li> </ul>
<p>GX Developer only</p>	<p>When transfer is executed by the GX Developer, a communication error sometimes occurs.</p>	<p>The GOT-F900 does not support the GX Developer (only in the initial version of the F940GOT).</p> <ul style="list-style-type: none"> <li>• Cause                             <p>The version of the GOT-F900 is earlier than 1.00 and does not correspond to the GX Developer.</p> </li> <li>• Countermeasures                             <p>Check the OS version of the GOT-F900, and upgrade the OS.</p> </li> </ul>

## 7. Connection of Two or More GOT Units

This chapter explains the setting method, the cable connection diagram and cautions when two or more GOT units are connected.

### Connection Procedure

#### 1. Preparation

Item name	Description	Reference
System Condition	You can learn the connection availability as well as the version of the GOT-F900 OS and the screen creation software.	7.1
System Configuration for Two or More GOT Units	You can select the GOT configuration and proper cables.	7.2
Rules in Configuration	You can learn the connection procedure in accordance with the specifications of the interface built in the GOT.	7.3
Connection of Four or More Display Units	This section introduces connection of two or more GOT units and the means to use satisfactorily the peripheral equipment for PLC.	7.4
Cautions on Connecting Two or More GOT Units	You can learn the restrictions in connecting two or more GOT units.	7.5

#### 2. Setting

Item name	Description	Reference
Setting of Connected Equipment for GOT	You can set the connection type (RS-232C/RS-422) of the second and later GOT units.	7.6

#### 3. Others

Item name	Description	Reference
Cable Diagram	Cable diagrams for two or more GOT unit connection.	7.7
Troubleshooting	Description of errors and how to fix them.	7.8

### 7.1 System Condition

When connecting two or more GOT units, check the COM port designation, the OS version of the GOT-F900 and applicable version of the screen creation software.

Have in mind that connection may not be allowed if the connected PLC (FX/A/QnA/Q Series PLC or microcomputer) is the CPU direct connection type or the OS version of the GOT-F900 Series does not match.

For OS version compatible with Q multiple PLC system, refer to Chapter 11.

GOT-F900 Series	COM port to which GOT can be connected		OS version of GOT-F900				
	RS-422	RS-232C	FXCPU	ACPU	QnACPU	QCPU <sup>*2</sup>	Microcomputer
F920GOT-K	–	–	–	–	–	–	–
F930GOT	✓	✓	1.00	1.00	2.00	2.20	3.00
F930GOT-K	✓	✓	4.60	4.60	4.60	4.60	4.60
F940GOT	✓	✓	1.00	1.00	3.00	4.10	5.00
F940WGOT	✓	✓					
F940 Handy GOT	✓ <sup>*1</sup>	–					
F943 Handy GOT	–	✓ <sup>*1</sup>					
Screen creation software	GT Designer2		SW-1A	SW-1A	SW-1A	SW-1A	SW-1A
	GT Designer		SW-1A	SW-1A	SW-2A	SW-4F	SW-1A
	DU/WIN		2.00	2.00	2.30	2.40	2.00

\*1 Only one Handy GOT unit can be connected at the end.

\*2 For the OS version compatible with Q Multi PLC System, refer to "Chapter 11. Connection of MELSEC-Q Series PLC."

## 7.2 Connection Configuration for Two or More GOT Units

When connecting two or more GOT-F900 units, for the first GOT-F900 unit, refer to the connection method for each equipment (FX/A/QnA/Q Series PLC and microcomputer) in this manual. This section explains cables required to connect among the second and later GOT units.

### Handling of the Handy GOT

Only one Handy GOT unit can be connected at the end. (Up to four GOT units can be connected in total including one Handy GOT unit).

### 7.2.1 Configuration When First GOT Unit is Connected through RS-422

This section explains the configuration when the first GOT-F900 is already connected through RS-422.

- The configuration of the first unit is as shown in the table below. For the details, however, refer to section explaining each connected equipment also.

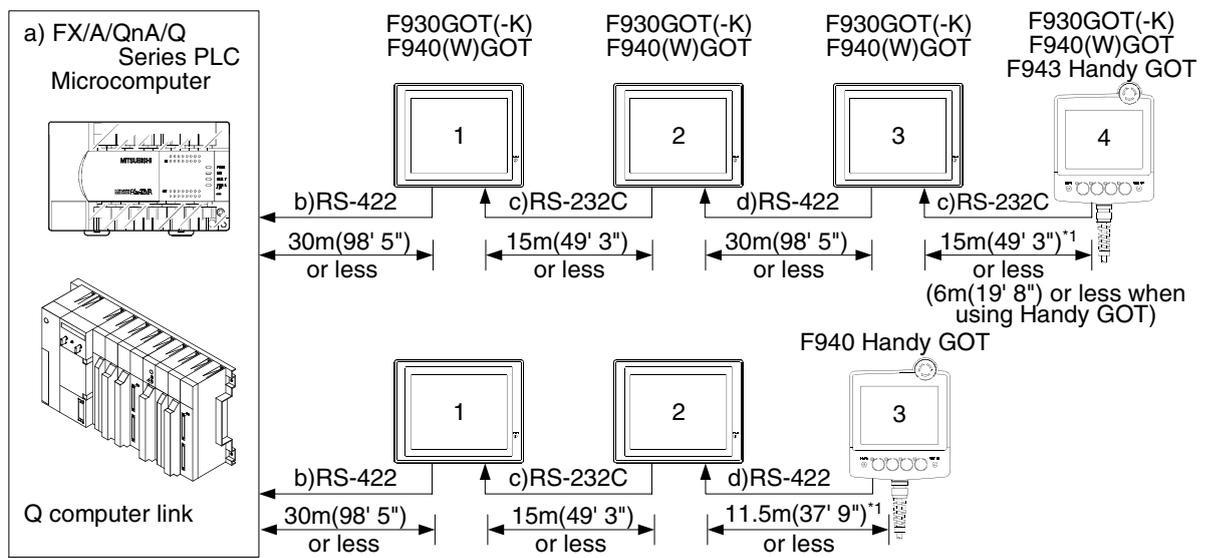

\*1 For the length of the Handy GOT cable, refer to chapter 5.



**1) F930GOT, F930GOT-K, F940GOT and F940WGOT**

a) FX/A/QnA/Q Series PLC, microcomputer	b) RS-422 cable	c) RS-232C cable	d) RS-422 cable
FX/FX2c (CPU direct connection) (25-pin D-Sub)	FX-40DU-CAB FX-40DU-CAB-□□M FX-50DU-CABL	FX-232CAB-1	Prepared by user (cross cable)
A/QnA (CPU direct connection) (25-pin D-Sub)			
FX0/FX0s/FX1s/FX0N/FX1N/FX2N/FX3U/FX2NC/ FX3NC (CPU direct connection) (8-pin MINI DIN)	FX-50DU-CAB0 FX-50DU-CAB0/EN FX-50DU-CAB0-□□M FX-50DU-CAB0L	FX-232CAB-1	Prepared by user (cross cable)
FX1s + FX1N-422-BD FX1N + FX1N-422-BD FX2N + FX2N-422-BD FX3U, FX3UC*1 + FX3U-422-BD (8-pin MINI DIN)			
QnA computer link connection	Prepared by user	FX-232CAB-1	Prepared by user (cross cable)
Q computer link connection	Prepared by user	FX-232CAB-1	Prepared by user (cross cable)
Microcomputer connection	Prepared by user	FX-232CAB-1	Prepared by user (cross cable)

- Among RS-422 cables in the FX-50DU-CABL and the FX-50DU-CAB0L cannot be used in the F930GOT/ F930GOT-K.

\*1 Excluding the FX3UC(D, DSS)

**2) Handy GOT**

Connection of the Handy GOT is as shown below: It is different from the cables shown in the previous page.

Connectable Handy GOT	Connected signal	Cable
F943 Handy GOT	c) RS-232C	Prepare another cable connecting the 25-in D-Sub connector of the F9GT-HCAB-□□M. Or connect the untied side of the F9GT-HCAB1-□□M.
F940 Handy GOT	d) RS-422	
F943 Handy GOT RH model	c) RS-232C	Prepare another cable connecting the 25-in D-Sub connector of the F9GT-RHCAB-□□M. Or connect the untied side of the F9GT-RHCAB1-□□M.
F940 Handy GOT RH model	d) RS-422	

1 Introduction

2 Outline

3 Specifications

4 Installation and Wiring of F940GOT

5 Installation and Wiring of Handy GOT

6 Connection of Peripheral Equipment

7 Connection of Two or More GOT Units

8 Connection of MELSEC-F FX Series PLC

9 Connection of MELSEC-A Series PLC

10 Connection of MELSEC-QnA Series PLC

7.2.2 When First GOT Unit is Connected through RS-232C

This section explains the configuration when the first GOT-F900 is already connected to some equipment (FX/Q Series PLC or microcomputer) through RS-232C.

- The configuration of the 1st unit is as shown in the table below. For the details, refer to section explaining each connected equipment also.

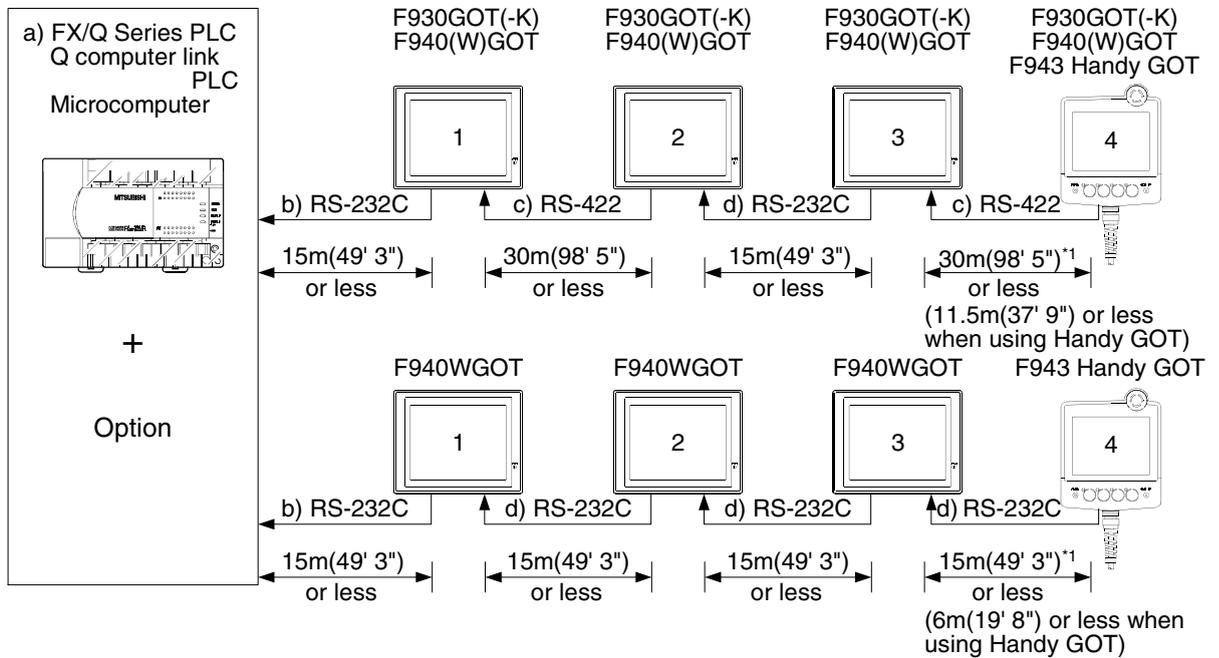

\*1 For the length of the Handy GOT cable, refer to chapter 5.

1) F930GOT, F930GOT-K, F940GOT and F940WGOT

a) FX/Q Series PLC	b) RS-232C cable	c) RS-422 cable	d) RS-232C cable
FX1S + FX1N-232-BD FX1N + FX1N-232-BD FX2N + FX2N-232-BD FX3U + FX3U-232-BD FX3UC*1 + FX3U-232-BD (9-pin D-Sub, male)	FX-232CAB-1	Prepared by user (cross cable)	FX-232CAB-1
FX1S + FX1N-CNV-BD + FX2NC-232ADP FX1N + FX1N-CNV-BD + FX2NC-232ADP FX2N + FX2N-CNV-BD + FX2NC-232ADP FX3U + Expansion Boards + FX3U-232ADP FX3UC*1 + Expansion Boards + FX3U-232ADP (9-pin D-Sub, male)			
FX2NC + FX2NC-232ADP FX3UC(D, DSS) + FX3U-232ADP (9-pin D-Sub, male)			
FX1S + FX1N-CNV-BD + FX0N-232ADP FX1N + FX1N-CNV-BD + FX0N-232ADP FX2N + FX2N-CNV-BD + FX0N-232ADP (25-pin D-Sub, female)	F2-232CAB-1		
FX2NC + FX0N-232ADP (25-pin D-Sub, female)			
QCPU(CPU direct connection) (6-pin MINI DIN)	QC30R2		
QnA computer link connection	Prepared by user		
Q computer link connection	Prepared by user		
Microcomputer connection	Prepared by user	Prepared by user	Prepared by user

\*1 Excluding the FX3UC(D, DSS)

2) Handy GOT

Connection of the Handy GOT is as shown below: It is different from the cables shown in the previous page.

Connectable Handy GOT	Connected signal	Cable
F943 Handy GOT	c) RS-232C	Prepare another cable connecting the 25-in D-Sub connector of the F9GT-HCAB-□□M. Or connect the untied side of the F9GT-HCAB1-□□M.
F940 Handy GOT	d) RS-422	
F943 Handy GOT RH model	c) RS-232C	Prepare another cable connecting the 25-in D-Sub connector of the F9GT-RHCAB-□□M. Or connect the untied side of the F9GT-RHCAB1-□□M.
F940 Handy GOT RH model	d) RS-422	

1	Introduction
2	Outline
3	Specifications
4	Installation and Wiring of F940GOT
5	Installation and Wiring of Handy GOT
6	Connection of Peripheral Equipment
7	Connection of Two or More GOT Units
8	Connection of MELSEC-FX Series PLC
9	Connection of MELSEC-A Series PLC
10	Connection of MELSEC-QnA Series PLC

### 7.2.3 When Connection is Changed from RS-422 to RS-232C

This section explains the method to change connection from RS-422 to RS-232C using the FX-232AW(C) RS-422/RS-232C converter when the connected equipment (FX/A/QnA Series PLC) is the RS-422 type.

- The configuration of the 1st unit is as shown in the table below. For the details, however, refer to chapter explaining each connected equipment also.

#### 1) When the FX-232AW(C) is used

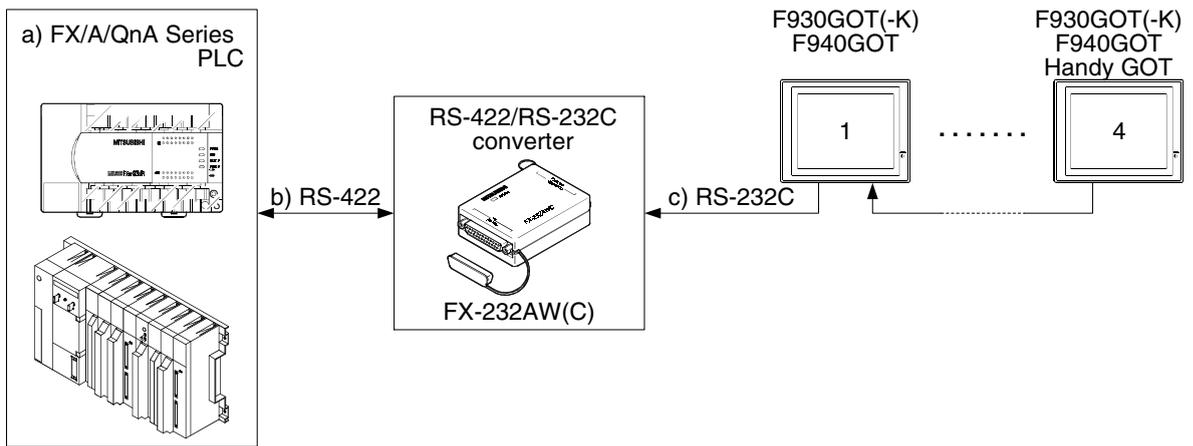

a) FX/A/QnA Series PLC	b) RS-422 cable	c) RS-232C cable	
FX/FX2C (CPU direct connection)	25-pin D-Sub	FX-422CAB	
A,QnA(CPU direct connection)			F2-232CAB-1
FX0/FX0S/FX1S/FX0N/FX1N/FX2N/FX3U/FX2NC/FX3UC (CPU direct connection)	8-pin MINI DIN	FX-422CAB0	
FX1S + FX1N-422-BD			F2-232CAB-1
FX1N + FX1N-422-BD			
FX2N + FX2N-422-BD			
FX3U + FX3U-422-BD			
FX3UC*1 + FX3U-422-BD			

\*1 Excluding the FX3UC(D, DSS)

### 7.3 Rules in Configuration

The GOT-F900 is equipped with two or more built-in serial communication connectors. Through alternate connection, up to four GOT-F900 units can be connected. This section explains the rules in configuration through alternate connection.

#### 7.3.1 Connection Method

By using the two-channel serial communication function built in the GOT, two or more GOT units can be connected alternately (daisy chain connection).

##### 1) Connection condition

Two or more GOT units can be connected to the following equipment.

- The CPU of the FX/A/QnA/Q Series PLC
- The QnA/Q Series serial communication unit
- A personal computer or microcomputer board

##### 2) Example of connection using F940GOT units

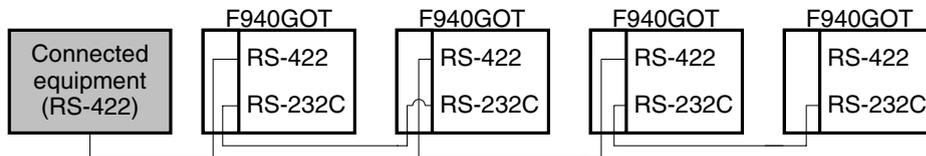

##### 3) Example of connection including a Handy GOT unit

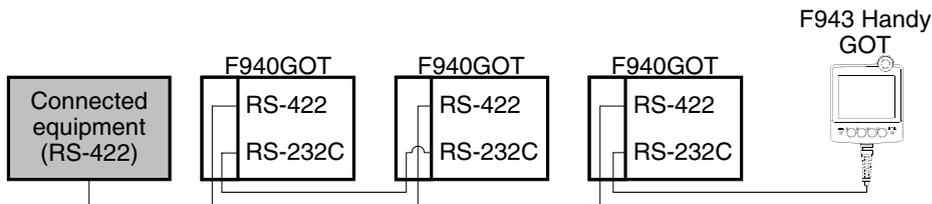

In RS-422 connection, one F940 Handy GOT unit can be connected.

##### 4) Example of unallowable connection

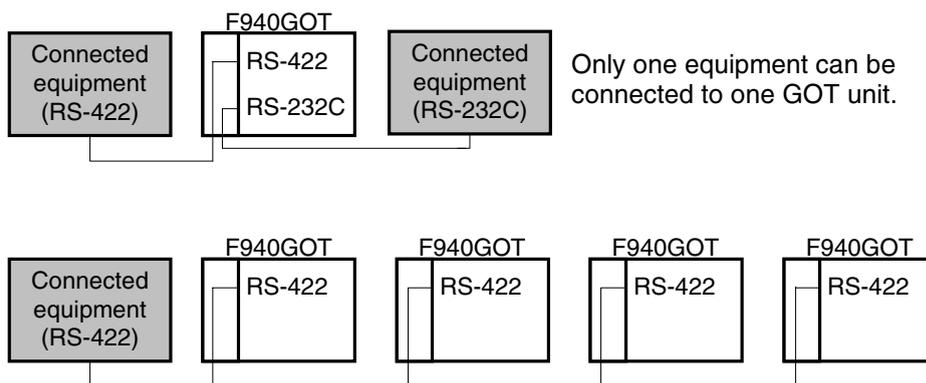

The "1:N" link connection with RS-422/485 is not allowed.

1	Introduction
2	Outline
3	Specifications
4	Installation and Wiring of F940GOT
5	Installation and Wiring of Handy GOT
6	Connection of Peripheral Equipment
7	Connection of Two or More GOT Units
8	Connection of MELSEC-FX Series PLC
9	Connection of MELSEC-A Series PLC
10	Connection of MELSEC-QnA Series PLC

### 7.3.2 Communication Port Number Table

The GOT-F900 Series is equipped with built-in serial interfaces as shown below.

GOT-F900	COM0	COM1	COM2	Remarks
F940WGOT	RS-422	RS-232C	RS-232C	Three channels are built in.
F940GOT F930GOT-K F930GOT	RS-422	RS-232C	Not provided	Two channels are built in.
F940 Handy GOT	RS-422	Not provided	Not provided	One channel is built in (one RS-232C channel for personal computer connection).
F943 Handy GOT	RS-232C	Not provided	Not provided	One channel is built in (one RS-232C channel for personal computer connection).

### 7.3.3 Connection Concept in Each Model Name

#### 1) F940WGOT

When the RS-422 (COM0) port is used to connect the PLC, connect the next GOT-F900 to the RS-232C (either COM1 or COM2) port. When the RS-232C (COM1) port is used to connect the PLC, connect the next GOT-F900 to the RS-422 (COM0) or RS-232C (COM2) port.

PLC connection side	To next GOT	Remarks
RS-422(COM0)	RS-232C (either COM1 or COM2)	
RS-232C(COM1)	RS-422(COM0)	
RS-232C(COM1)	RS-232C(COM2)	

#### 2) F930GOT/F930GOT-K/F940GOT

When the RS-422 (COM0) port is used to connect the PLC, connect the next GOT-F900 to the RS-232C (COM1) port.

When the RS-232C (COM1) port is used to connect the PLC, connect the next GOT-F900 to the RS-422 (COM0).

PLC connection side	To next GOT	Remarks
RS-422(COM0)	RS-232C (COM1)	
RS-232C(COM1)	RS-422(COM0)	

#### 3) Handy GOT

Only one Handy GOT unit can be connected at the end of two or more GOT units. After the Handy GOT, no GOT-F900 can be connected.

PLC connection side	To next GOT	Remarks
RS-422(COM0)	Can not connect <sup>*1</sup>	In the case of F940 Handy GOT
RS-232C(COM0)	Can not connect <sup>*1</sup>	In the case of F943 Handy GOT

<sup>\*1</sup> The RS-232C port for the Handy type GOT is provided inside the rear cover. As a result, environmental protection is lost when using this port and such a connection is not practical. (The Handy GOT can be connected as the final unit in a string of two or more GOTs.)

### 7.4 Connection of Four or More Display Units

When satisfactory operation, program transfer at high speed and monitor response are required through connection of peripheral equipment for the PLC (dedicated equipment or personal computer) while two or more (sometimes more than four) GOT units are connected, the following configurations are recommended.

#### 1) Adding a programming port using an option

In the FX1S/FX1N/FX2N/FX3U/FX2NC/FX3UC Series, programming port can be added by installing an option. By this method, prepare a port to connect a peripheral equipment for the PLC (display unit) and a port to connect a display unit.

Applicable PLC	Signal name	Optional model name
FX1S Series FX1N Series	RS-422	FX1N-422-BD
	RS-232C	FX1N-232BD
		FX1N-CNV-BD + FX0N-232ADP FX1N-CNV-BD + FX2NC-232ADP
FX2N Series	RS-422	FX2N-422-BD
	RS-232C	FX2N-232BD
		FX2N-CNV-BD + FX0N-232ADP FX2N-CNV-BD + FX2NC-232ADP
FX3U, FX3UC*1 Series	RS-422	FX3U-422-BD
	RS-232C	FX3U-232BD Expansion Boards + FX3U-232ADP
FX2NC Series	RS-232C	FX0N-232ADP
		FX2NC-232ADP
FX3UC(D, DSS) Series	RS-232C	FX3UC-232ADP

\*1 Excluding the FX3UC(D, DSS)

[Configuration example] FX2N-422-BD + FX2N Series

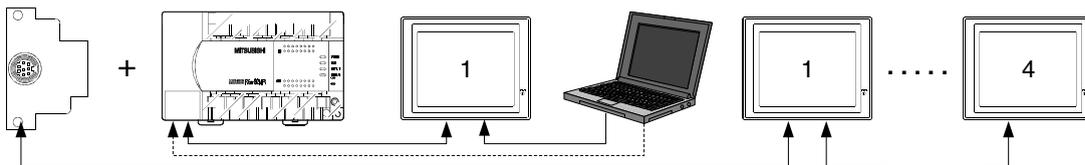

- 1 Introduction
- 2 Outline
- 3 Specifications
- 4 Installation and Wiring of F940GOT
- 5 Installation and Wiring of Handy GOT
- 6 Connection of Peripheral Equipment
- 7 Connection of Two or More GOT Units
- 8 Connection of MELSEC-F FX Series PLC
- 9 Connection of MELSEC-A Series PLC
- 10 Connection of MELSEC-QnA Series PLC

**2) Using the PLC easy link function**

The PLC easy link function enables to connect up to eight FX1S/FX0N/FX1N/FX2N/FX3U/FX2NC/FX3UC Series PLC units. To each PLC unit, GOT-F900 units can be connected.

Applicable PLC	Model name	Total PLC extension distance
FX0N Series	FX0N-485ADP	500m (1640')
	FX2NC-485ADP	
FX1S Series FX1N Series	FX1N-485-BD	50m (164')
	FX1N-CNV-BD + FX0N-485ADP	500m (1640')
	FX1N-CNV-BD + FX2NC-485ADP	
FX2N Series	FX2N-485-BD	50m (164')
	FX2N-CNV-BD + FX0N-485ADP	500m (1640')
	FX2N-CNV-BD + FX2NC-485ADP	
FX3U, FX3UC <sup>*1</sup> Series	FX3U-485-BD	50m (164')
	Expansion Boards + FX3U-485ADP	500m (1640')
FX2NC	FX0N-485ADP	500m (1640')
	FX2NC-485ADP	
FX3UC(D, DSS) Series	FX3UC-485ADP	500m (1640')

- When the FX1N/FX2N/FX3U-485BD is included in the system, the total extension distance is 50m (164').

\*1 Excluding the FX3UC(D, DSS)

[Configuration example] FX2N-485-BD + FX2N Series

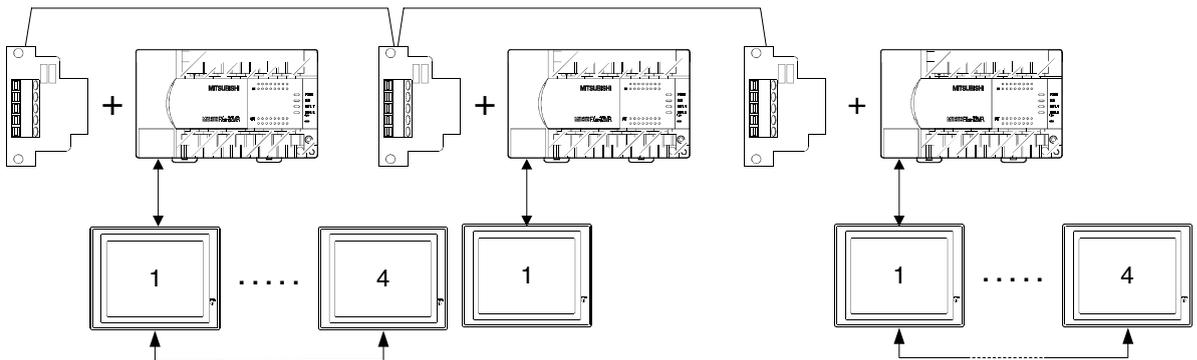



## 7.5 Cautions on Connecting Two or More GOT Units

This section explains the cautions on use of two or more connected GOT units.

### 7.5.1 Power ON Sequence

When connecting two or more GOT units, confirm the model of the connected equipment (FX/A/QnA/Q Series PLC, microcomputer) by executing communication in turn from the first GOT-F900 unit (1st GOT-F900 → 2nd GOT-F900 → 3rd GOT-F900 → 4th GOT-F900).

For example, if the power is turned on in the 1st and 4th GOT-F900 units, then turned on in the 2nd and 3rd GOT-F900 units after a while, a communication error occurs in the 4th GOT-F900 unit.

And even when the power is turned on in four GOT-F900 units at the same time, if communication starts as soon as the opening screen is displayed in the GOT units and it takes considerable time until communication is enabled in the 4th GOT-F900 unit, a communication error may occur.

#### 1) Communication timing

If communication is aborted for some reason, it is retried. If communication is not executed in the specified judgement time, a communication error occurs.

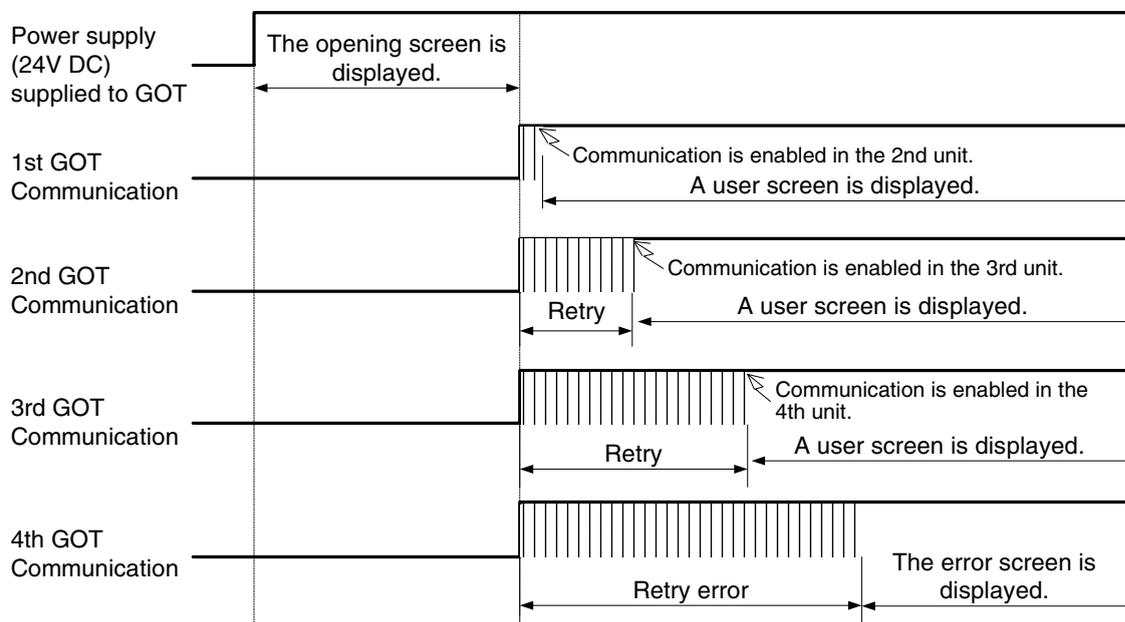

#### 2) Countermeasures

To prevent communication errors, the communication start timing in the GOT-F900 should be delayed using the following method.

- Delay the timing of turning on the power of the GOT-F900 and the connected equipment (FX/A/QnA/Q Series PLC, microcomputer).  
Set the sequence to "connected equipment → 1st GOT unit → 2nd GOT unit → 3rd GOT unit → 4th GOT unit".
- While the opening screen is being displayed, communication is not executed.  
Accordingly, adjust the opening screen display time to delay the communication start timing.  
Change the title screen display time on the "SET-UP MODE" screen in the GOT or in the screen creation software.  
1st GOT unit (default value) → 2nd GOT unit (default value + 5 sec) → 3rd GOT unit (default value + 10 sec) → 4th GOT unit (default value + 15 sec)

**7.5.2 Communication speed between GOT units**

When multiple GOT units are connected, the communication speed becomes slower. If the communication speed of the first unit is "1", the second one is "1/2", the third one "1/4", and the fourth one "1/8".

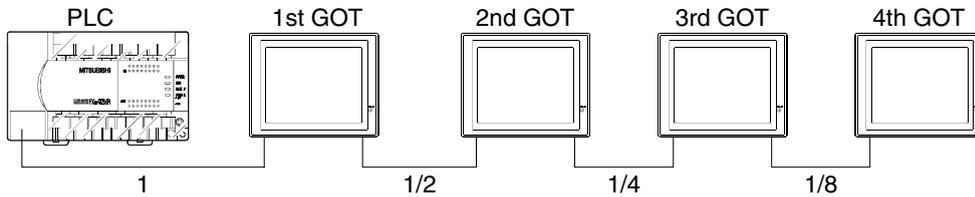

**7.5.3 Transfer of sequence program and use of monitor**

This section explains the restriction on sequence program transfer and device monitoring through a personal computer connected to a GOT unit while two or more GOT units are connected. (Excluding microcomputer connection)

**1) When a personal computer is connected to the last GOT unit**

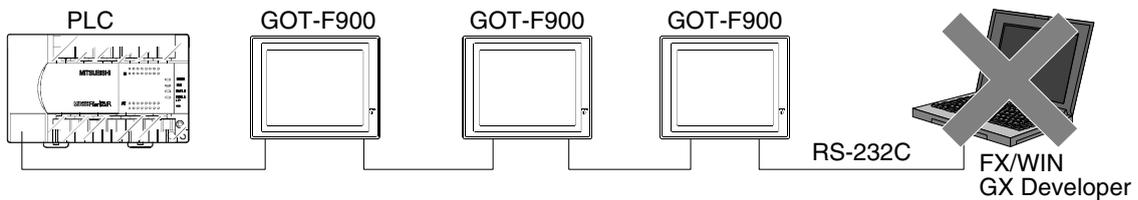

Even if there is an unused RS-232C connector in the last connected GOT unit, connection and use of a personal computer are disabled for the following reasons.

- a) Because the response is slow during device monitoring, this connection cannot be recommended for practical use.
- b) Because the communication time is long during program transfer or monitoring, a communication error may occur in the software installed in the personal computer.

**2) When a personal computer is connected to the F940WGOT**

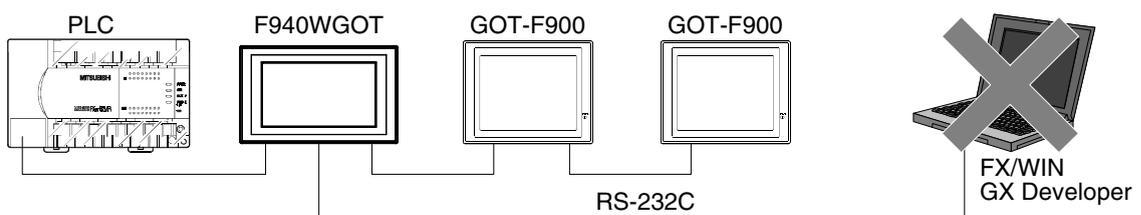

The F940WGOT is equipped with 2 channels of RS-232C connectors. However, if the F940WGOT is connected to a GOT unit and a personal computer at the same time, sequence program transfer and monitoring are disabled.

The two-port interface function is available only for either the function to connect two or more GOT units or the program transfer/monitoring function. (Use of these two functions at the same time is not allowed.)

### 7.5.4 Cautions on use of F940WGOT

When the second GOT is connected to RS-232C (COM1), it takes another few seconds to display a user screen via the opening screen after the power is turned on.

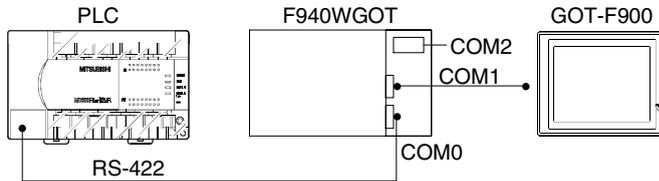

### 7.5.5 Cautions on setting the screen creation software of GOT-F900

When setting the system information of each GOT, make sure that a same device number is not assigned to two or more GOT units by paying attention to the occupied device number. Especially when a device number is assigned to the same device number in write device, the GOT from which the information comes cannot be specified.

1

Introduction

2

Outline

3

Specifications

4

Installation  
and Wiring of  
F940GOT

5

Installation  
and Wiring of  
Handy GOT

6

Connection of  
Peripheral  
Equipment

7

Connection of  
Two or More  
GOT Units

8

Connection of  
MELSEC-F FX  
Series PLC

9

Connection of  
MELSEC-A  
Series PLC

10

Connection of  
MELSEC-QnA  
Series PLC

## 7.6 Setting of Connected Equipment for GOT

The setting for connecting two or more GOT units can be executed using the GOT-F900 and the screen creation software (GT Designer2, GT Designer or DU/WIN).

### 7.6.1 Connection Type (RS-422/RS-232C setting)

- 1) Using the screen creation software, specify the connected PLC type (such as the FX Series) to all GOT-F900 units.
- 2) In each GOT-F900 unit, the communication port should be set to RS-422 or RS-232C.

For example, suppose that four GOT-F900 units are connected to the RS-422 port of the FX Series PLC. In every GOT-F900 unit, set the PLC type to the FX Series.

In the 1st and 3rd GOT-F900 units, set the communication port to RS-422.

In the 2nd and 4th GOT-F900 units, set the communication port to RS-232C.

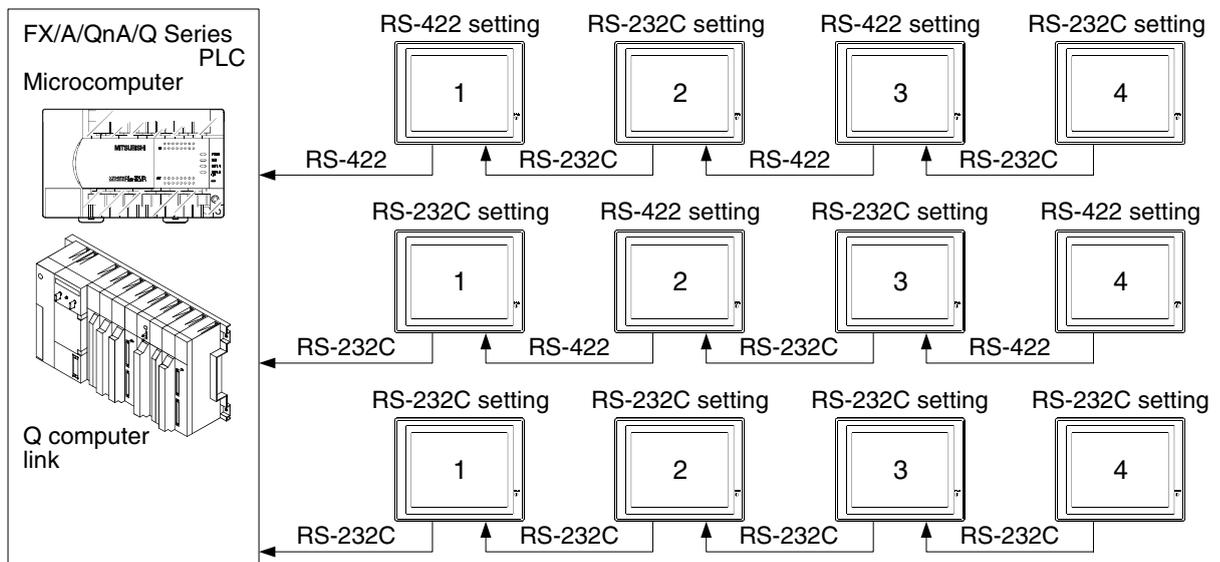

### 7.6.2 Station Number Setting

Set the station number to "00" in every GOT-F900 unit.

In the case of microcomputer connection, however, set a value other than 00.

In connection of two or more GOT units from the microcomputer, the value set to the station number can be specified by the communication commands for identification. (If the station number is set to "00", the function to connect two or more GOT units is disabled, and communication is executed using the conventional communication commands.)

Connection	Connected PLC	Station number	Remarks
FXCPU	FX Series	00	
ACPU	A Series	00	
QnACPU	QnA/Q Series	00	
QCPU		00	
QnA computer link		00	
Q computer link		00	
Microcomputer	General-purpose communication	Other than 00 *1	Different value in range from 01 to 31

\*1 In the case of microcomputer connection, set the station number in the range from 01 to 31 while making sure that a same value is not assigned to two or more GOT-F900 units. If the station number is set to "00", the microcomputer and the GOT-F900 are connected on the "1:1" basis, and the function to connect two or more GOT units is disabled.

7.6.3 Setting Procedure

1) GOT-F900 Series

When the SELECT MODE screen change operation is disabled.

Operation	Display (screen name)
a) While pressing and holding the upper left corner of the screen, turn on the power. Keep holding the upper left corner for about 25 seconds more. Then, press "END" at the upper right corner.	The "LANGUAGE" screen appears.
b) Press "PLC TYPE".	The "SET-UP MODE" screen appears.
c) Set the following. PLC TYPE: FX SERIES A SERIES QnA, Q SERIES Q (MULTI) SERIES UNIVERSAL CONNECTION: CPU PORT (RS-422) CPU PORT (RS-232C) DST STATION # (STATION #) :00 (01 to 31 for microcomputer connection) GOT STATION # (-) : -	The "PLC TYPE" screen appears.

When the SELECT MODE screen change operation is enabled.

Operation	Display (screen name)
a) Press the upper left corner of the screen. (The position to be pressed can be changed in the GOT and the screen creation software.)	The "SELECT MODE" screen appears.
b) Press "OTHER MODE" on the menu.	The "OTHER MODE" screen appears.
c) Press "SET-UP MODE" on the menu.	The "SET-UP MODE" screen appears.
d) Press "PLC TYPE".	The "PLC TYPE" screen appears.
e) Set the following. PLC TYPE: FX SERIES A SERIES QnA, Q SERIES Q (MULTI) SERIES UNIVERSAL CONNECTION: CPU PORT (RS-422) CPU PORT (RS-232C) DST STATION # (STATION #) :00 (01 to 31 for microcomputer connection) GOT STATION # (-) : -	

- Be aware that when the screen data is transferred to the GOT-F900, the old data including the PLC type, connection type, and station number are overwritten.

1	Introduction
2	Outline
3	Specifications
4	Installation and Wiring of F940GOT
5	Installation and Wiring of Handy GOT
6	Connection of Peripheral Equipment
7	Connection of Two or More GOT Units
8	Connection of MELSEC-F FX Series PLC
9	Connection of MELSEC-A Series PLC
10	Connection of MELSEC-QnA Series PLC

2) GT Designer2

	Operation	Display (screen name)								
[Creation]	<p>a) Open GT Designer2.</p> <p>b) Click the [NEW] button. The dialog box shown below is displayed. If it is not displayed, click "System Environment" in the tree displayed in the project work space, then click "System Settings" in the tree.</p>  <p>c) Set the following.</p> <p>GOT type: F940WGOT (480 × 234)                    F94*GOT (320 × 240)                    F93*GOT (240 × 80)</p> <p>PLC type: MELSEC-FX                    MELSEC-A                    MELSEC-QnA, Q                    MELSEC-Q (Multi)                    Computer</p> <p>Selection of "GOT type"</p> <table border="1" data-bbox="485 1155 1114 1373"> <thead> <tr> <th>GOT type</th> <th>Model name (name)</th> </tr> </thead> <tbody> <tr> <td>F940WGOT(480×234)&lt;WIDE&gt;</td> <td>F940WGOT</td> </tr> <tr> <td>F94*GOT(320×240)</td> <td>F940GOT Handy GOT</td> </tr> <tr> <td>F930GOT(240×80)</td> <td>F930GOT F930GOT-K</td> </tr> </tbody> </table> <p>Click [OK].</p>	GOT type	Model name (name)	F940WGOT(480×234)<WIDE>	F940WGOT	F94*GOT(320×240)	F940GOT Handy GOT	F930GOT(240×80)	F930GOT F930GOT-K	<p>The "Select Project" dialog box appears.</p> <p>The "System Environment" dialog box appears.</p>
GOT type	Model name (name)									
F940WGOT(480×234)<WIDE>	F940WGOT									
F94*GOT(320×240)	F940GOT Handy GOT									
F930GOT(240×80)	F930GOT F930GOT-K									

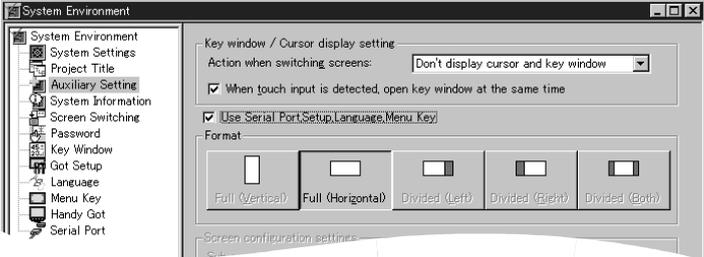
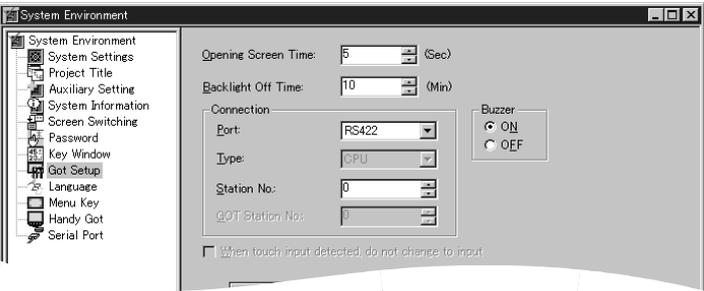
	Operation	Display (screen name)
	<p>d) Setting the port (RS-422 or RS-232C) of the GOT-F900</p> <p>Click "Auxiliary Setting" in the tree of the system environment menu.</p> <p>Click the check box of "Use Serial Port, Setup, Language, Menu Key" to give a check mark (✓).</p>  <p>Click "Got Setup" in the tree of the system environment menu.</p> 	<p>The "Project Auxiliary Settings" dialog box appears.</p>
RS-422 connection	<p>e) Set the following.</p> <p>Port : RS-422</p> <p>Type : CPU</p> <p>Station No. : 00 (01 to 31 for microcomputer connection)</p> <p>GOT Station No. : -</p>	
RS-232C connection	<p>e) Set the following.</p> <p>Port : RS-232C</p> <p>Type : CPU</p> <p>Station No. : 00 (01 to 31 for microcomputer connection)</p> <p>GOT Station No. : -</p> <p>In the case of F943 Handy GOT</p> <p>Without regard to the port setting (RS-422 or RS-232C), the COM0 side of the RS-232C is fixed for PLC connection.</p>	
[Change method]	<p>Change the connection type of the already created data as follows.</p> <p>a) Open GT Designer2.</p> <p>b) Click the [Project]-[Open] button.</p> <p>c) Open (read) the screen data to be changed.</p> <p>d) On the menu, select "Common"- "System Environment".</p> <ul style="list-style-type: none"> <li>- For the contents of setting, refer to c) of [Creation] above.</li> <li>- For selection of the RS-422 or the RS-232C, refer to e) of [Creation] above.</li> </ul>	<p>The "Select Project" dialog box appears.</p> <p>The "System Environment" dialog box appears.</p>

1	Introduction
2	Outline
3	Specifications
4	Installation and Wiring of F940GOT
5	Installation and Wiring of Handy GOT
6	Connection of Peripheral Equipment
7	Connection of Two or More GOT Units
8	Connection of MELSEC-FX Series PLC
9	Connection of MELSEC-A Series PLC
10	Connection of MELSEC-QnA Series PLC

3) GT Designer

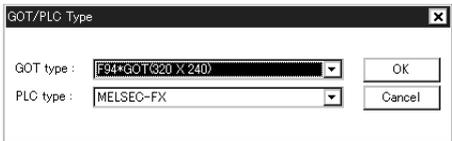
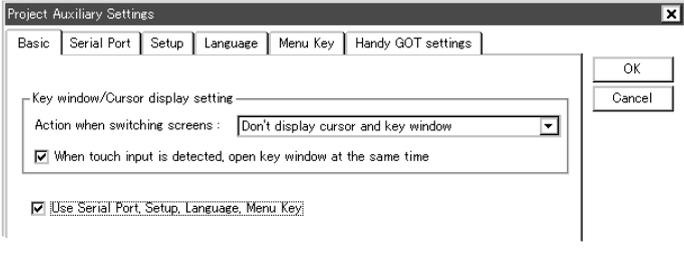
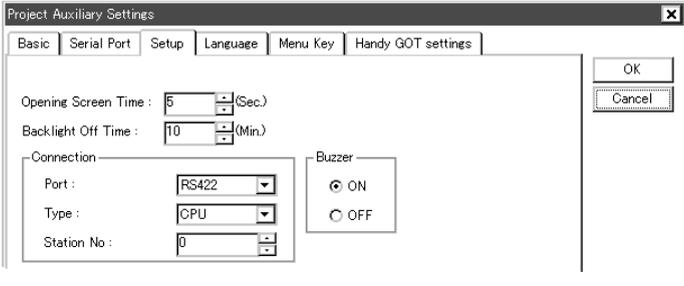
Operation		Display (screen name)								
[Creation]	<p>a) Open GT Designer.</p> <p>b) Click the [NEW] button.</p>  <p>c) Set the following.            GOT type: F940WGOT (480 × 234)                      F940GOT (320 × 240)                      F930GOT (240 × 80)            PLC type: MELSEC-FX                      MELSEC-A                      MELSEC-QnA, Q                      MELSEC-Q (Multi)                      Computer            Selection of "GOT type"</p> <table border="1" data-bbox="496 869 1104 1088"> <thead> <tr> <th>GOT type</th> <th>Model name</th> </tr> </thead> <tbody> <tr> <td>F940WGOT(480×234)&lt;WIDE&gt;</td> <td>F940WGOT</td> </tr> <tr> <td>F940GOT(320×240)</td> <td>F940GOT Handy GOT</td> </tr> <tr> <td>F930GOT(240×80)</td> <td>F930GOT F930GOT-K</td> </tr> </tbody> </table> <p>Click [OK].</p> <p>d) Set CPU direct connection (RS-422/RS-232C) of the GOT-F900. This setting is enabled in the SW4D5C-GOTR-PACKE version A or later.            Click the check box of "Use Serial Port, Setup, Language, Menu Key" to give a check mark (✓).</p>  <p>Click the "Setup" tab.</p>  <p>In the case of SW4D5C-GOTR-PACKE earlier than version A, perform the setting in the GOT-F900.            (Set the connection in "CONNECTION" in the GOT-F900.)            For the setting method, refer to "1) GOT-F900 Series" on the previous page.</p>	GOT type	Model name	F940WGOT(480×234)<WIDE>	F940WGOT	F940GOT(320×240)	F940GOT Handy GOT	F930GOT(240×80)	F930GOT F930GOT-K	<p>The "Select Project" dialog box appears.</p> <p>The "GOT/PLC Type" dialog box appears.</p> <p>The "Project Auxiliary Settings" dialog box appears.</p>
GOT type	Model name									
F940WGOT(480×234)<WIDE>	F940WGOT									
F940GOT(320×240)	F940GOT Handy GOT									
F930GOT(240×80)	F930GOT F930GOT-K									



Operation		Display (screen name)
RS-422 connection	e)Set the following. Port : RS-422 Type : CPU DST Station No. (Station No.) : 00 (01 to 31 for microcomputer connection) GOT Station No. (-) : -	The "Setup Data" dialog box appears.
RS-232C connection	e)Set the following. Port : RS-232C Type : CPU DST Station No. (Station No.) : 00 (01 to 31 for microcomputer connection) GOT Station No. (-) : -	The "Setup Data" dialog box appears.
[Change method]	Change the connection type of the already created data as follows. a)Open GT Designer. b)Click the [Open] button. c)Open (read) the screen data to be changed. d)On the menu, select "Common"->"GOT/PLC Type". - For the contents of setting, refer to c) of [Creation] above. - For selection of the RS-422 or the RS-232C, refer to e) of [Creation] above.	The "Select Project" dialog box appears. The "GOT/PLC Type" dialog box appears.

1

Introduction

2

Outline

3

Specifications

4

Installation and Wiring of F940GOT

5

Installation and Wiring of Handy GOT

6

Connection of Peripheral Equipment

7

Connection of Two or More GOT Units

8

Connection of MELSEC-F FX Series PLC

9

Connection of MELSEC-A Series PLC

10

Connection of MELSEC-QnA Series PLC

4) DU/WIN

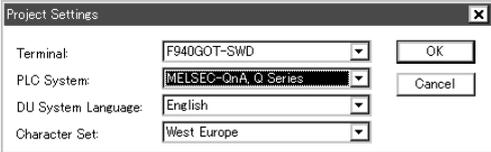
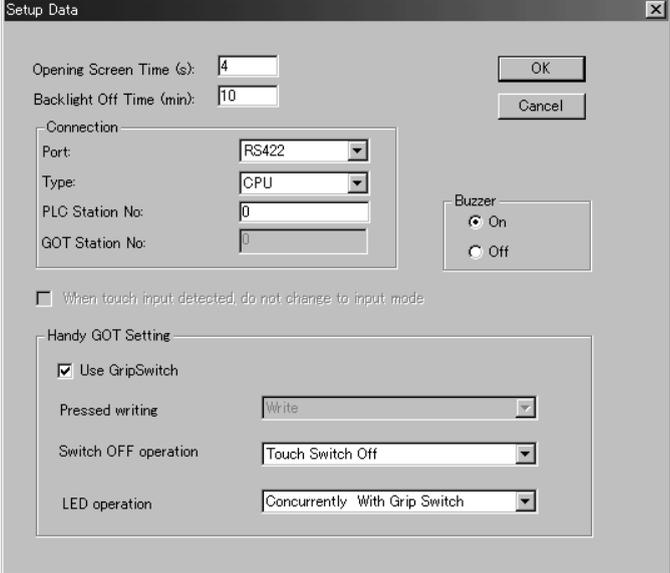
	Operation	Display (screen name)								
[Creation]	<p>a) Open DU/WIN.</p> <p>b) On the menu, select "File"-"New".</p>  <p>c) Set the following.</p> <p>Terminal: F940GOT-LWD F940GOT-SWD F930GOT-BWD</p> <p>PLC System: MELSEC-FX MELSEC-A MELSEC-QnA, Q General</p> <p>Select "Terminal" in accordance with the LCD display color.</p> <table border="1" data-bbox="497 826 1098 1072"> <thead> <tr> <th>DU type</th> <th>Model name</th> </tr> </thead> <tbody> <tr> <td>F940GOT-LWD</td> <td>F940GOT (black and white) Handy GOT (black and white)</td> </tr> <tr> <td>F940GOT-SWD</td> <td>F940GOT (color) Handy GOT (color)</td> </tr> <tr> <td>F930GOT-BWD</td> <td>F930GOT-K (blue) F930GOT (blue)</td> </tr> </tbody> </table>	DU type	Model name	F940GOT-LWD	F940GOT (black and white) Handy GOT (black and white)	F940GOT-SWD	F940GOT (color) Handy GOT (color)	F930GOT-BWD	F930GOT-K (blue) F930GOT (blue)	The "Project settings" dialog box appears.
DU type	Model name									
F940GOT-LWD	F940GOT (black and white) Handy GOT (black and white)									
F940GOT-SWD	F940GOT (color) Handy GOT (color)									
F930GOT-BWD	F930GOT-K (blue) F930GOT (blue)									
RS-422 connection	<p>d) Set CPU direct connection (RS-422) of the GOT-F900. On the menu, select "View/Project"-"System Settings"-"Setup Data".</p>  <p>e) Set the following.</p> <p>Port: RS-422 Type: CPU DST Station No. (Station No.): 00 (01 to 31 for microcomputer connection) GOT Station No. (-) : -</p>	The "Setup Data" dialog box appears.								

Operation		Display (screen name)
RS-232C connection	d) For selecting RS-232C of the GOT-F900, select "View/Project"- "System Settings"- "Setup Data" on the menu. e) Set the following. Port: RS-232C Type: CPU DST Station No. (Station No.): 00 (01 to 31 for microcomputer connection) GOT Station No. (-) : -	The "Setup Data" dialog box appears.
[Change method]	Change the connection type of the already created data as follows. a) Open DU/WIN. b) On the menu, select "File"- "Open". c) Select and open (read) the file of the screen data to be changed.	The "Open" dialog box appears.
	d) When changing "Terminal" (GOT-F900), select "View/Project"- "System Settings"- "Project settings" on the menu. For the contents of setting, refer to c) in [Creation] above. For setting of RS-232C/RS-422 of the FX Series, refer to d) in [Creation] above.	The "Project settings" dialog box appears.

1	Introduction
2	Outline
3	Specifications
4	Installation and Wiring of F940GOT
5	Installation and Wiring of Handy GOT
6	Connection of Peripheral Equipment
7	Connection of Two or More GOT Units
8	Connection of MELSEC-F FX Series PLC
9	Connection of MELSEC-A Series PLC
10	Connection of MELSEC-QnA Series PLC

### 7.7 Cable Diagram

This section explains cable diagrams to connect the 1st and later GOT-F900 units.

#### 7.7.1 Cautions on preparing cables

When preparing the cables, use the wire size of 0.08mm<sup>2</sup> or more (AWG28 or more) for communication, 0.3mm<sup>2</sup> or more (AWG22 or more) for the power supply, operation switch, and emergency stop switch. Do not use a twisted pair cable with the power supply wire and the communication wire.

#### 7.7.2 Cable diagram

##### 1) Cable for the GOT and the GOT (in connection of two or more GOT units)

In the case of non microcomputer connection

 : Female type   
  : Male type   
 The connector figure shows the engagement face.

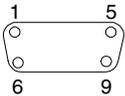
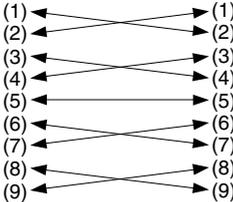
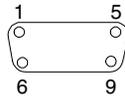
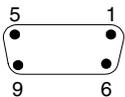
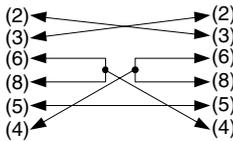
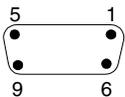
No.	Model name	Application	Connection diagram	Application
a)	RS-422 connection Connection of two or more GOT units Prepared by the user	To GOT-F900  9-pin D-Sub, male		To GOT-F900  9-pin D-Sub, male
b)	RS-232C connection FX-232CAB-1	To GOT-F900  9-pin D-Sub, female		To GOT-F900  9-pin D-Sub, female

In the case of microcomputer connection

 : Female type   
  : Male type   
 The connector figure shows the engagement face.

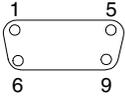
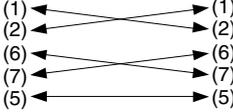
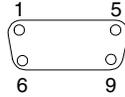
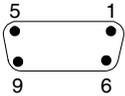
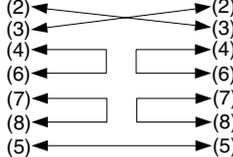
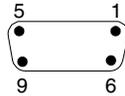
No.	Model name	Application	Connection diagram	Application
c)	RS-422 connection Connection of two or more GOT units Prepared by the user ( a ) in the table above is also available.)	To GOT-F900  9-pin D-Sub, male		To GOT-F900  9-pin D-Sub, male
d)	RS-232C connection	To GOT-F900  9-pin D-Sub, female		To GOT-F900  9-pin D-Sub, female

2) Cable for the GOT and the Handy GOT (in connection of two or more GOT units)

 : Female type  : Male type The connector figure shows the engagement face.

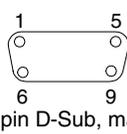
No.	Model name	Application	Connection diagram	Application
a)	<p>RS-422 connection</p> <p>To GOT-F900</p>  <p>9-pin D-Sub, male</p> <p>Connection of two or more GOT units Prepared by the user</p> <p>Wire the power supply, the operation switches and the emergency stop switch.</p>	<p>Wiring according to the pin number of F9GT-HCAB-□□M</p> <p>FG(shield) ← (1) Drain wire</p> <p>(2) BK</p> <p>(3) Y</p> <p>(4) R</p> <p>(5) BL</p> <p>(6) O</p> <p>(7) W</p> <p>(8) BR</p> <p>(9) GR</p> <p>(9) GY</p> <p>DC24VG ← (12) PL</p> <p>DC24VG ← (13) PK</p> <p>ES1-2 / SW-COM ← (14) LTGR</p> <p>DSW2 / SW1 ← (15) SB</p> <p>DSW2 / SW2 ← (16) BK/W</p> <p>DSW1 / SW3 ← (17) R/W</p> <p>DSW1 / SW4 ← (18) GR/W</p> <p>ES1-2 / (20) O/W</p> <p>ES1-1 / ES1 ← (21) Y/W</p> <p>ES1-1 / ES1 ← (22) BR/W</p> <p>DC24V+ ← (24) BL/W</p> <p>DC24V+ ← (25) GY/W</p> <p>Old cable description ← → New cable description</p> <p>Wiring according to the wire color of F9GT-HCAB1-□□M</p>	<p>To cable F9GT-HCAB or F9GT-HCAB1 of F940 Handy GOT</p>	
				b)

1	Introduction
2	Outline
3	Specifications
4	Installation and Wiring of F940GOT
5	Installation and Wiring of Handy GOT
6	Connection of Peripheral Equipment
7	Connection of Two or More GOT Units
8	Connection of MELSEC-FX Series PLC
9	Connection of MELSEC-A Series PLC
10	Connection of MELSEC-QnA Series PLC

In the case of microcomputer connection

 : Female type  : Male type The connector figure shows the engagement face.

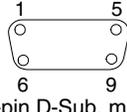
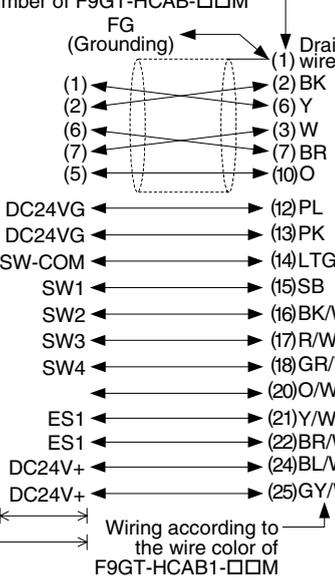
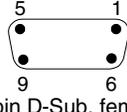
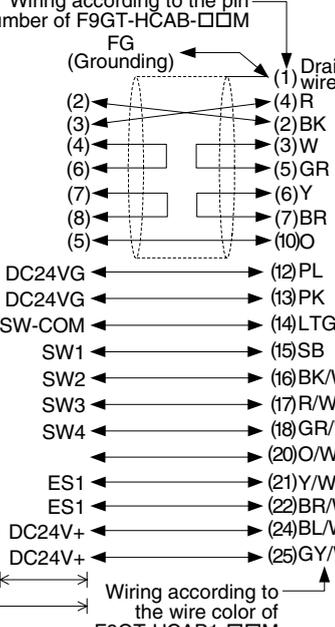
No.	Model name	Application	Connection diagram	Application
c)	<p><b>RS-422 connection</b></p> <p>To GOT-F900</p>  <p>9-pin D-Sub, male</p> <p><b>Connection of two or more GOT units Prepared by the user</b></p> <p>(a) in the table above is also available.)</p> <p>Wire the power supply, the operation switches and the emergency stop switch.</p>	<p>Wiring according to the pin number of F9GT-HCAB-□□M</p>  <p>Old cable description ← → New cable description</p> <p>Wiring according to the wire color of F9GT-HCAB1-□□M</p>	<p>To cable F9GT-HCAB or F9GT-HCAB1 of F940 Handy GOT</p>	
d)	<p><b>RS-232C connection</b></p> <p>To GOT-F900</p>  <p>9-pin D-Sub, female</p> <p>Wire the power supply, the operation switches and the emergency stop switch.</p>	<p>Wiring according to the pin number of F9GT-HCAB-□□M</p>  <p>Old cable description ← → New cable description</p> <p>Wiring according to the wire color of F9GT-HCAB1-□□M</p>	<p>To cable F9GT-HCAB or F9GT-HCAB1 of F943 Handy GOT</p>	

3) Cable for the PLC/personal computer and the FX-232AW(C)

 : Female type  : Male type The connector figure shows the engagement face.

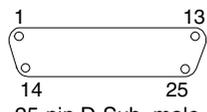
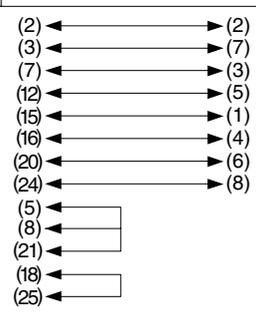
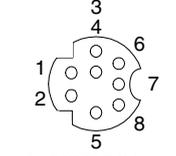
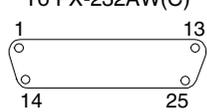
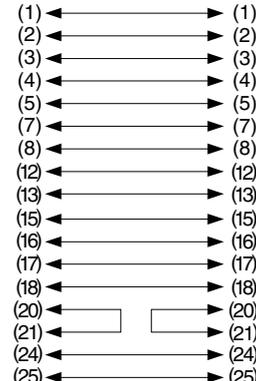
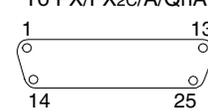
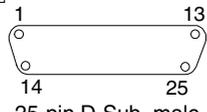
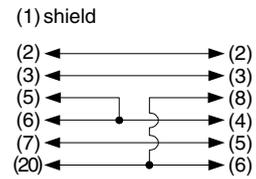
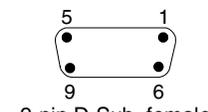
No.	Model name	Application	Connection diagram	Application
a)	FX-422CAB0	<p>RS-422 connection</p> <p>To FX-232AW(C)</p>  <p>25-pin D-Sub, male</p>		<p>To FX0/FX0S/FX1S/ FX0N/FX1N/FX2N/ FX3U/FX2NC/FX3UC</p>  <p>8-pin MINI DIN, male</p>
b)	FX-422CAB	<p>RS-422 connection</p> <p>To FX-232AW(C)</p>  <p>25-pin D-Sub, male</p>		<p>To FX/FX2c/A/QnA</p>  <p>25-pin D-Sub, male</p>
c)	F2-232CAB-1	<p>RS-232C connection</p> <p>To FX-232AW(C)</p>  <p>25-pin D-Sub, male</p>		<p>To GOT-F900</p>  <p>9-pin D-Sub, female</p>

1	Introduction
2	Outline
3	Specifications
4	Installation and Wiring of F940GOT
5	Installation and Wiring of Handy GOT
6	Connection of Peripheral Equipment
7	Connection of Two or More GOT Units
8	Connection of MELSEC-F FX Series PLC
9	Connection of MELSEC-A Series PLC
10	Connection of MELSEC-QnA Series PLC

## 7.8 Troubleshooting

For reference, this section summarizes frequently asked questions about connection of two or more GOT units.

### 1) GOT-F900

Classification	Contents of trouble	Check points and countermeasures
GOT-F900	"COMMUNICATION ERROR OCCURS" is displayed when a screen changeover or numeric data input is performed on the GOT-F900 screen.	Nothing is displayed on the screen of some GOT units.  <ul style="list-style-type: none"> <li>• Causes Communication is disabled because the power of the connected equipment is turned off.</li> <li>• Countermeasures Turn on the power.</li> </ul>
		Some of the connected GOT units do not display.  <ul style="list-style-type: none"> <li>• Causes The power has been turned on before or at the same instant as connected equipment was turned on.</li> <li>• Countermeasures Turn on the connected equipment first. Set the opening screen display period longer.</li> </ul>
		The first GOT unit (closest from connected equipment) displays an user screen, but the second and later (further) GOT units do not.  <ul style="list-style-type: none"> <li>• Causes The second and later GOT units has not been ready to communicate before display of the opening screen of the first GOT finished. The power of the second and later GOT is turned off.</li> <li>• Countermeasures Set the opening screen display period longer. Turn on the second and later GOT.</li> </ul>
GT Designer DU/WIN	When the screen data is transferred by the screen creation software, "No response from terminal", etc. is displayed.	The RS-232C port of the GOT-F900 is allocated to another connected equipment (bar code reader or printer).  <ul style="list-style-type: none"> <li>• Causes 1)"RS-232C" is specified for PLC connection. 2)The bar code reader is set valid. 3)The printer is set valid. Confirm the settings above in the screen creation software.</li> <li>• Countermeasures Select by hand the data transfer mode in the GOT-F900. Start up the system screen, display the "SELECT MODE" screen, select "OTHER MODE" - "DATA TRANSFER" on the menu, then transfer the screen data.</li> </ul>
GOT-F900	When the screen data is transferred by the screen creation software, the "DATA TRANSFER" screen does not appear in the GOT-F900.	



## 8. Connection of MELSEC-F FX Series PLC

This chapter explains connection of the GOT-F900 Series display unit to the FX Series PLC.

### Connection Procedure

This section introduces the procedure to connect the GOT-F900 to the FX Series PLC.

#### 1. Preparation

Item name	Description	Reference
System Condition	You can learn the connection availability as well as the version of the GOT-F900 OS and the screen creation software.	8.1
System Configuration	You can select the configuration between the GOT and the FX Series PLC and proper cables.	8.2

#### 2. Setting

Item name	Description	Reference
FXCPU Selection in Direct Connection	When FXCPU connection is selected, the GOT-F900 is automatically set to fixed values. No setting is required in the FX Series PLC.	–
Cautions on Use of MELSEC-F FX Series	You can learn the restrictions in connecting the GOT to the FX Series PLC.	8.3
Setting of Connected Equipment for GOT	Set the PLC type using the GOT or the screen creation software.	8.4

#### 3. Others

Item name	Description	Reference
Cable Diagram	Cable diagrams for FX Series PLC/GOT connection.	8.5
Troubleshooting	Description of errors and how to fix them	8.6

### 8.1 System Condition

When connecting the FX Series PLC, check the COM port designation, the OS version of the GOT-F900, and the applicable version of the screen creation software.

Compatibility when connecting FX Series PLC

GOT-F900 Series	COM port		Connection type		OS version of GOT-F900	Version of screen creation software		
	RS-422	RS-232C	1:1	Two or more GOT units		GT Designer2	GT Designer	DU/WIN
F920GOT-K(5V)	✓	–	✓	–	1.00	SW1-C	SW5-26C	2.70
F920GOT-K(24V)	✓	✓	✓	–	1.20	SW1-C	–	–
F930GOT	✓	✓	✓	✓	1.00	SW1-C	SW1-H	2.20
F930GOT-K	✓	✓	✓	✓	4.60	SW1-C	SW5-26C	2.70
F940GOT	✓	✓	✓	✓	1.00	SW1-C	SW1-A	2.00
F940WGOT	✓	✓	✓	✓	1.00	SW1-C	SW5-F	2.50
F940 Handy GOT	✓	–	✓	–*1	1.00	SW1-C	SW1-D	2.10
F943 Handy GOT	–	✓	✓	–*1	1.00	SW1-C	SW1-D	2.10

- "RS-232C" in the "COM port" column may not be available in some FX Series PLC. Refer to section 3.1.

- The screen creation software version corresponds to the model of the GOT-F900 Series. Refer to section 3.2.

\*1 The RS-232C port for the Handy type GOT is provided inside the rear cover. As a result, environmental protection is lost when using this port and such a connection is not practical. (The Handy GOT can be connected as the final unit in a string of two or more GOTs.)

## 8.2 System Configuration

The FX Series PLC can be directly connected to the GOT via RS-422 or RS-232C. This section explains the cables and options required in such a system.

### 8.2.1 Applicable model

The GOT-F900 can be connected to the following equipment in accordance with its OS version. Operations are not assured when the GOT-F900 is connected to any other equipment. For details of the OS version of the GOT-F900 and applicable equipment, refer to "3.1 OS Version and Correspondence to Connected Equipment of GOT-F900".

CPU <sup>*1</sup>	OPTION	COMMUNICATION PORT
FX0 FX0S FX0N FX2C FX	–	Connection to programming port
FX1S FX1N	–	Connection to programming port
	FX1N-422-BD	Connection to extended communication port
	FX1N-232-BD	
	FX1N-CNV-BD + FX0N-232ADP	
FX1N-CNV-BD + FX2NC-232ADP		
FX2N	–	Connection to programming port
	FX2N-422-BD	Connection to extended communication port
	FX2N-232-BD	
	FX2N-CNV-BD + FX0N-232ADP	
FX2N-CNV-BD + FX2NC-232ADP		
FX3U FX3UC <sup>*2</sup>	–	Connection to programming port
	FX3U-422-BD	Connection to extended communication port
	FX3U-232-BD	
Expansion Boards + FX3U-232ADP		
FX2NC	–	Connection to programming port
	FX0N-232ADP	Connection to extended communication port
	FX2NC-232ADP	
FX3UC(D, DSS)	–	Connection to programming port
	FX3U-232ADP	Connection to extended communication port

\*1 Applicable ranges of the FX3U/FX3UC Series PLC are limited to function ranges provided in the FX2N/FX2NC Series PLC such as instruction and device ranges and program size.

Do not use the following functions in the HPP mode when the GOT-F900 is connected to the FX3U/FX3UC Series PLC:

- Program list
- Parameter
- List monitor

\*2 Excluding the FX3UC(D, DSS)

### 8.2.2 Configuration for CPU Direct Connection (RS-422)

Connect the GOT-F900 to the programming port of the FX Series PLC. Program transfer and monitoring are available in the GOT-F900 Series using the built-in two-port interface function through connection of a personal computer to the RS-232C port. (In the Handy GOT, the rear cover would have to be open.)

#### 1) F920GOT-K/F930GOT/F930GOT-K/F940GOT/F940WGOT

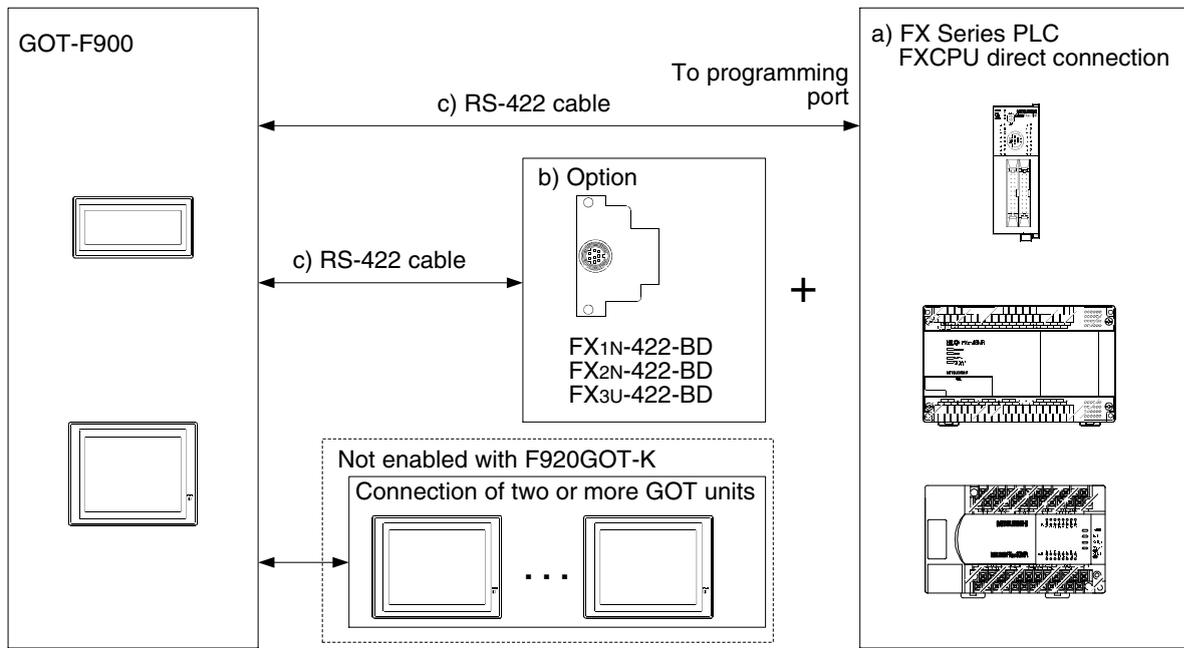

a) FX Series PLC		b) Option	c) RS-422 cable
FX0/FX0S/FX0N	FXCPU direct connection (8-pin MINI DIN)	-	FX-50DU-CAB0 FX-50DU-CAB0/EN
FX1S/FX1N	FXCPU direct connection (8-pin MINI DIN)	FX1N-422-BD	FX-50DU-CAB0-□□M FX-50DU-CAB0L
FX2N	FXCPU direct connection (8-pin MINI DIN)	FX2N-422-BD	
FX3U, FX3UC*1	FXCPU direct connection (8-pin MINI DIN)	FX3U-422-BD	
FX2NC, FX3UC(D, DSS)	FXCPU direct connection (8-pin MINI DIN)	-	
FX/FX2C	FXCPU direct connection (25-pin D-Sub)	-	FX-40DU-CAB FX-40DU-CAB-□□M FX-50DU-CABL

- Only one of the cables listed in column c) is required for connection.
- The L type cable, FX-50DU-CAB0L or FX-50DU-CABL (cable with a right angle connector), cannot be used for F920GOT-K, F930GOT or F930GOT-K.
- Note the following distinctions when using the F920GOT-K (5V type):
  - Only the FX-50DU-CAB0, FX-50DU-CAB0/EN and FX-50DU-CAB0-1M are applicable.
  - The c) RS-422 cable (3m (9' 10") or shorter) to connect to the FX/FX2c Series PLC needs to be prepared by the user.

Before attempting to connect the GOT units per b) Option above, "8.3 Cautions on Use of MELSEC-F FX Series" should be read and understood.

\*1 Excluding the FX3UC(D, DSS)

1	Introduction
2	Outline
3	Specifications
4	Installation and Wiring of F940GOT
5	Installation and Wiring of Handy GOT
6	Connection of Peripheral Equipment
7	Connection of Two or More GOT Units
8	Connection of MELSEC-F FX Series PLC
9	Connection of MELSEC-A Series PLC
10	Connection of MELSEC-QnA Series PLC

2) F940 Handy GOT (RS-422)

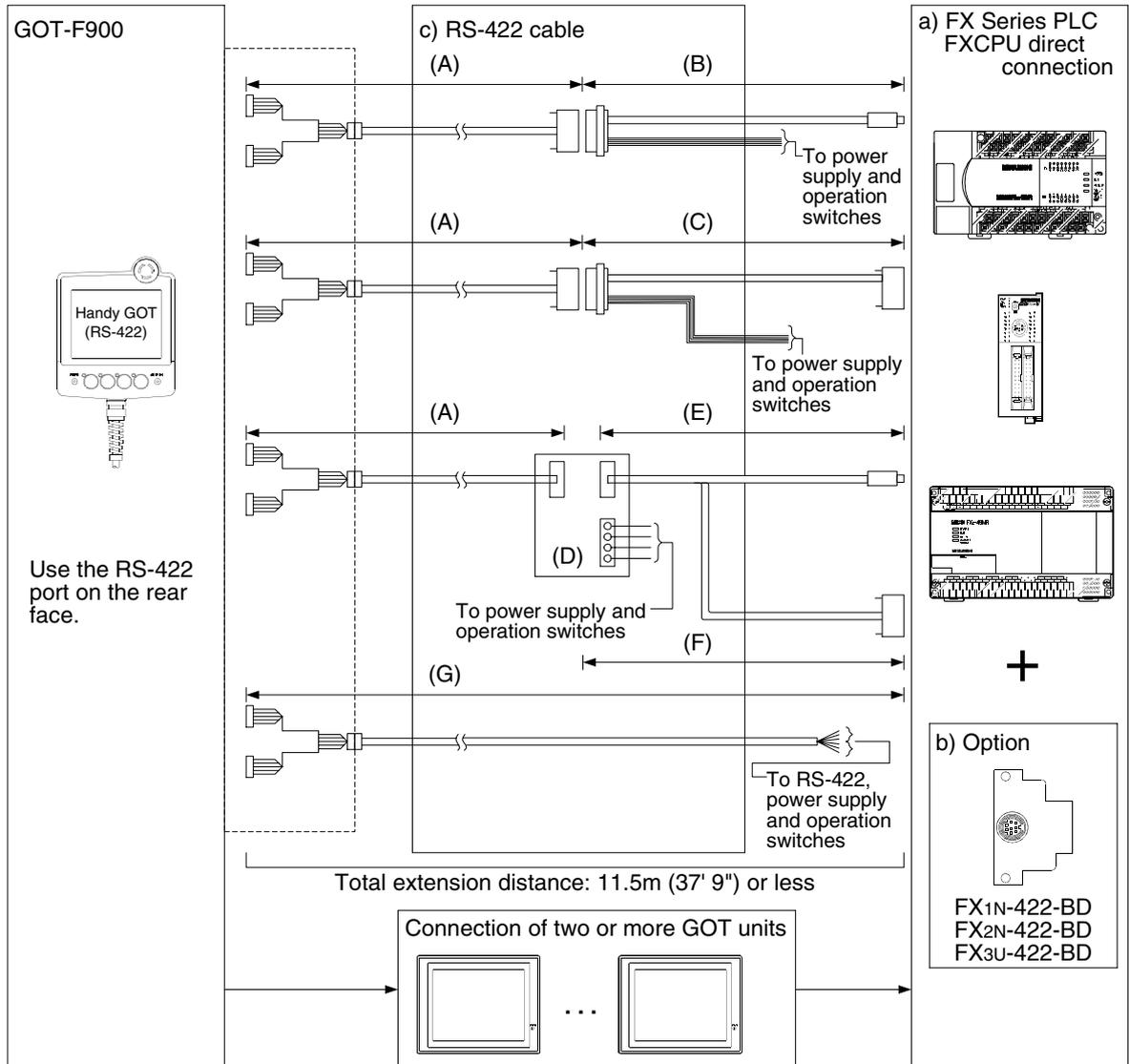

a) FX Series PLC	b) Option	c) RS-422 cable
FX0/FX0s/FX0	FXCPU direct connection (8-pin MINI DIN)	(A)F9GT-HCAB-□□□□
FX1S/FX1N	FXCPU direct connection (8-pin MINI DIN)	(B)F9GT-HCAB2-150
FX2N	FXCPU direct connection (8-pin MINI DIN)	(D)F9GT-HCNB
		(E)FX-50DU-CAB0, FX-50DU-CAB0/EN or FX-50DU-CAB0-1M
FX3U, FX3UC* <sup>1</sup>	FXCPU direct connection (8-pin MINI DIN)	(G)F9GT-HCAB1-□□□□
FX2NC, FX3UC(D, DSS)	FXCPU direct connection (8-pin MINI DIN)	
FX/FX2C	FXCPU direct connection (25-pin D-Sub)	(A)F9GT-HCAB-□□□□ (C)F9GT-HCAB3-150 (F)FX-40DU-CAB (G)F9GT-HCAB1-□□□□

- Make sure that the total cable extension distance "(A) + (B)", (A) + (C)" or (G) is 11.5m (37' 9") or less. Before attempting to connect the GOT units per b) Option above, "8.3 Cautions on Use of MELSEC-F FX Series" should be read and understood.

\*1 Excluding the FX3UC(D, DSS)

### 8.2.3 Configuration for CPU Direct Connection (RS-232C)

By attaching an option for RS-232C communication to the FX Series PLC (FX1S/FX1N/FX2N/FX3U/FX2NC/FX3UC only), the GOT-F900 can be connected via RS-232C.

Because the programming port of the FX Series PLC is not occupied by the GOT-F900, a personal computer or dedicated machine (such as the A6GPP and the A7PHP) can be connected for monitoring and transfer of sequence programs or another GOT-F900 unit can be connected.

#### 1) F920GOT-K (24V type)/F930GOT/F930GOT-K/F940GOT/F940WGOT

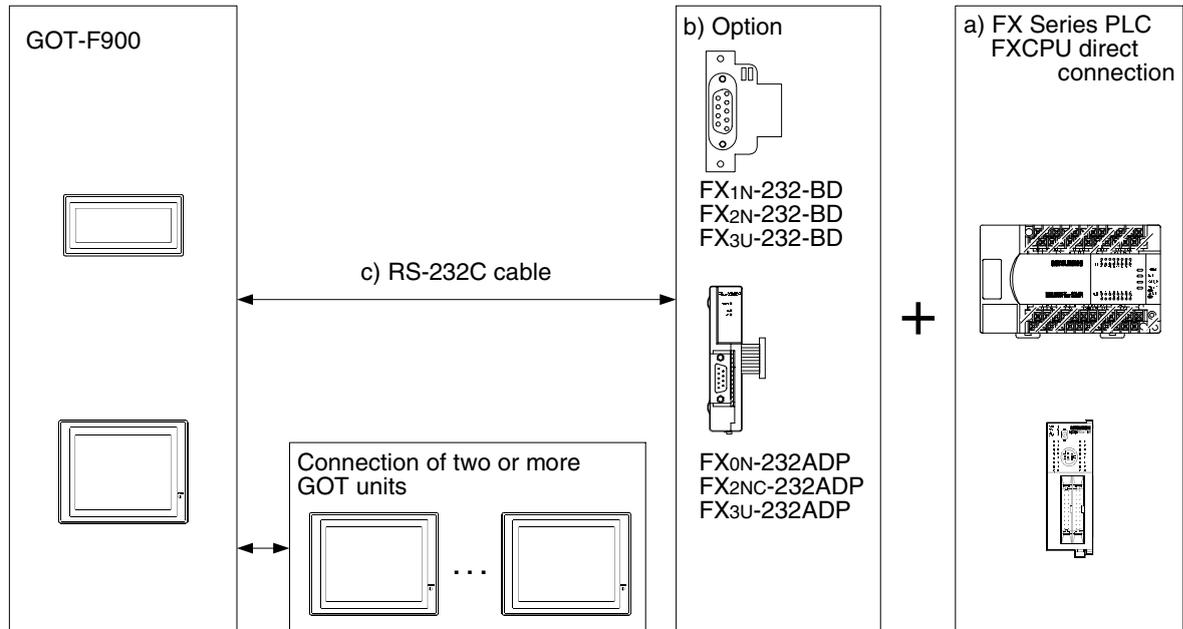

a) FX Series PLC		b) Option	c) RS-232C cable
FX1S/FX1N	FXCPU direct connection (9-pin D-Sub)	FX1N-232-BD FX1N-CNV-BD + FX2NC-232ADP	FX-232CAB-1
	FXCPU direct connection (25-pin D-Sub)	FX1N-CNV-BD + FX0N-232ADP	F2-232CAB-1
FX2N	FXCPU direct connection (9-pin D-Sub)	FX2N-232-BD FX2N-CNV-BD + FX2NC-232ADP	FX-232CAB-1
	FXCPU direct connection (25-pin D-Sub)	FX2N-CNV-BD + FX0N-232ADP	F2-232CAB-1
FX3U, FX3UC*1	FXCPU direct connection (9-pin D-Sub)	FX3U-232-BD	FX-232CAB-1
		Expansion Boards + FX3U-232ADP	
FX2NC	FXCPU direct connection (9-pin D-Sub)	FX2NC-232ADP	F2-232CAB-1
	FXCPU direct connection (25-pin D-Sub)	FX0N-232ADP	F2-232CAB-1
FX3UC(D, DSS)	FXCPU direct connection (9-pin D-Sub)	FX3U-232ADP	FX-232CAB-1

Before attempting to connect the GOT units per b) Option above, "8.3 Cautions on Use of MELSEC-F FX Series" should be read and understood.

\*1 Excluding the FX3UC(D, DSS)

1 Introduction  
2 Outline  
3 Specifications  
4 Installation and Wiring of F940GOT  
5 Installation and Wiring of Handy GOT  
6 Connection of Peripheral Equipment  
7 Connection of Two or More GOT Units  
8 Connection of MELSEC-F FX Series PLC  
9 Connection of MELSEC-A Series PLC  
10 Connection of MELSEC-QnA Series PLC

2) F943 Handy GOT

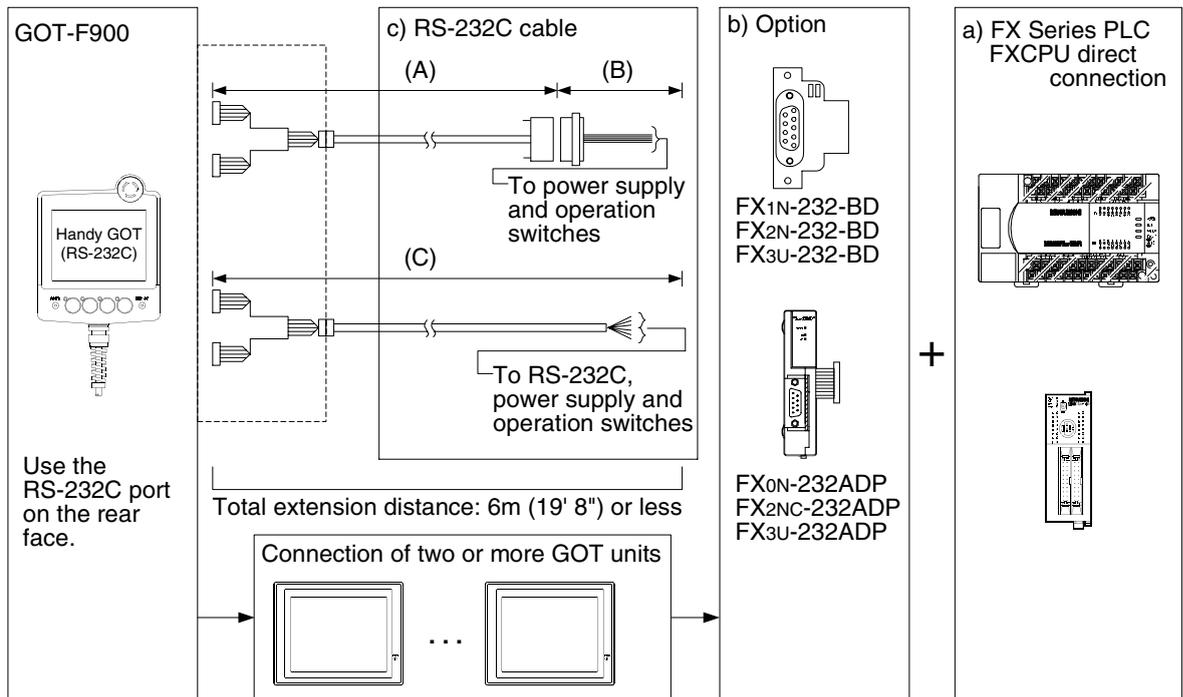

a) FX Series PLC		b) Option	c) RS-232C cable
FX1S/FX1N	FXCPU direct connection (9-pin D-Sub)	FX1N-232-BD FX1N-CNV-BD + FX2NC-232ADP	(A)F9GT-HCAB-□□M
	FXCPU direct connection (25-pin D-Sub)	FX1N-CNV-BD + FX0N-232ADP	(B)Prepared by the user
FX2N	FXCPU direct connection (9-pin D-Sub)	FX2N-232-BD FX2N-CNV-BD + FX2NC-232ADP	(C)F9GT-HCAB1-3M
	FXCPU direct connection (25-pin D-Sub)	FX2N-CNV-BD + FX0N-232ADP	
FX3U, FX3UC <sup>*1</sup>	FXCPU direct connection (9-pin D-Sub)	FX3U-232-BD Expansion Boards + FX3U-232ADP	
	FXCPU direct connection (9-pin D-Sub)	FX2NC-232ADP	
FX2NC	FXCPU direct connection (25-pin D-Sub)	FX0N-232ADP	
	FXCPU direct connection (9-pin D-Sub)	FX3U-232ADP	

- In the (C)F9GT-HCAB1-3M shown in the column "c) RS-232C cable", the end on the PLC side is loose wires.
- Make sure that the total cable extension distance "(A) + (B)" or (C) is 6 m or less.

Before attempting to connect the GOT units per b) Option above, "8.3 Cautions on Use of MELSEC-F FX Series" should be read and understood.

\*1 Excluding the FX3UC(D, DSS)

## 8.3 Cautions on Use of MELSEC-F FX Series

When using the GOT-F900 connected to the FX Series PLC, observe the following cautions on use.

### 8.3.1 Device specification

The device range specifications vary depending on the model of the FXCPU.

Input relays (X) X000 to X377 can be read only.

It is not allowed to specify a bit device as a word device or specify a word device as a bit device.

For the details, refer to section 3.3.

### 8.3.2 Devices which can be monitored

Specify the device No. of input relays (X) and output relays (Y) in octal (1, 2, 3 ... 7, 10, 11 ... 17, 20).  
Specify the device No. of other devices in decimal.

Only devices described in "3.3 Device Names Which can be Monitored" can be specified.

### 8.3.3 When GOT-F900 is connected to optional port

When connecting the GOT-F900 to the FX Series PLC using an extended function board or special communication adapter, the communication mode should be set to "programming communication" (selected at shipment from the factory).

If any protocol other than the protocol for programming connection is selected or if the communication mode is set incorrectly, reset the setting in reference to the following procedure.

Reset the setting using a sequence program or software.

#### 1) To set by a sequence program

- Delete the no protocol communication (RS, RS2 instruction) for the port connecting the GOT-F900.
- Delete programs set by computer link, easy PLC link and parallel link for the port connecting the GOT-F900.
- Delete the setting of communication parameters.

(If the parameters are set using the software for sequence program, refer to the description on the setting by the software also.)

Excluding the FX3U, FX3UC : D8120

FX3U, FX3UC : D8120, D8400, D8420

**For the details on the program settings, refer to the "FX User's Manual [Data Communication Edition]"**.

**2) To set by GX Developer (GPP/W)**

Open GX Developer.

- Read the sequence program to a personal computer.
- From the project data list tree, select "Parameter"->"PLC Parameter".  
If the tree is not displayed, check "Project data list" in "View".
- When the "FX parameter" dialog box appears, click the "PLC system (2)" tab.

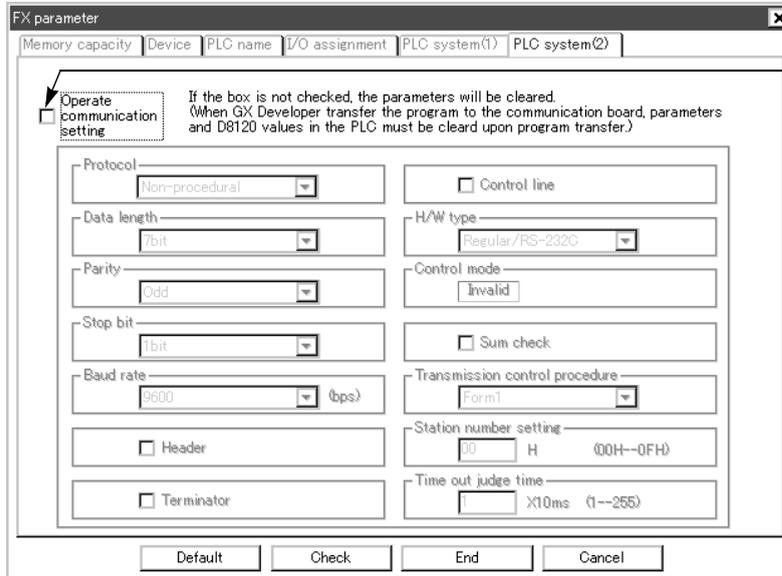

Click here to delete the check mark.

- After changing the setting, transfer the program and turn off the PLC power.  
The parameters are written into the special data register when the PLC is turned on.



**3) To set by the software FX/WIN**

Open FX/WIN. (The setting menu may not be provided in some versions.)

The setting can be executed in the offline mode (by setting parameters) and the online mode (direct writing to D8120 of the FX Series PLC) as shown below. Confirm the setting in each mode.

**1. Offline (setting by parameters)**

- Read the sequence program to the personal computer.
- On the menu, select "Option"->"Serial setting (parameter)".
- Check the display on the dialog box to confirm whether or not there is a setting.  
If the confirmation dialog box shown on the left is displayed, there is no setting.  
If the setting screen shown on the right is displayed, click [Clear] to cancel the current data.

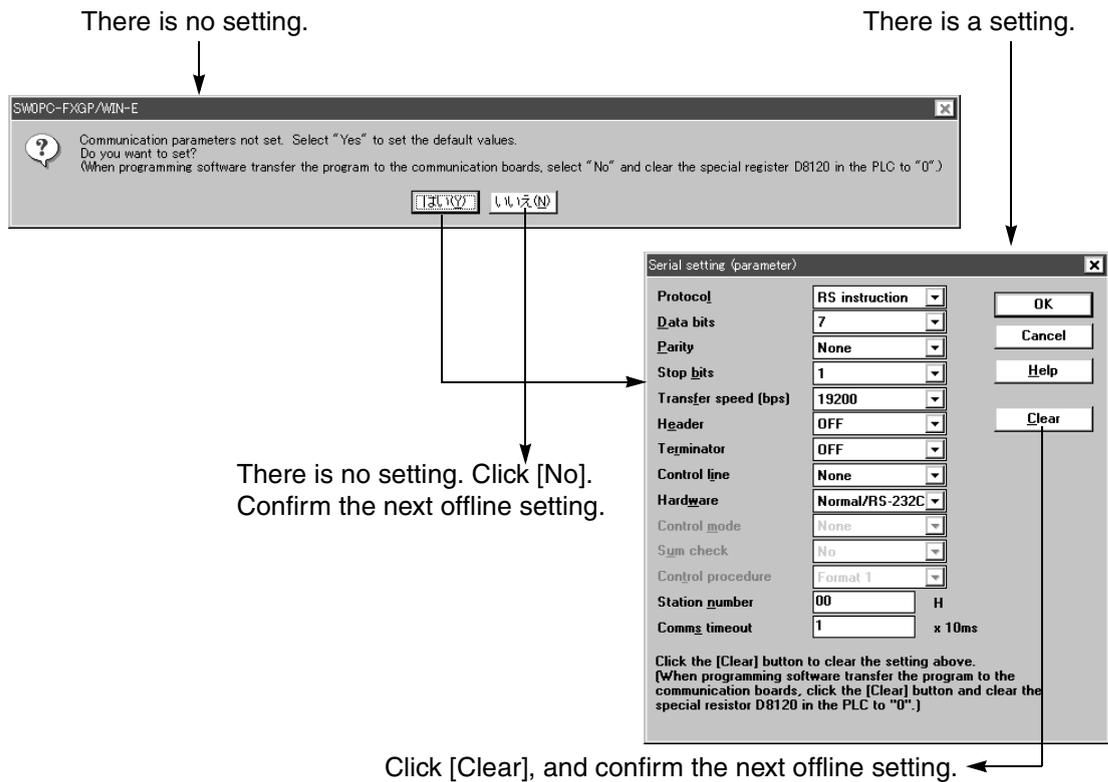

**2. Online (direct writing to D8120 of the FX Series PLC)**

- On the menu, select "PLC"->"Serial setting (D8120)".
- The setting dialog box is displayed.

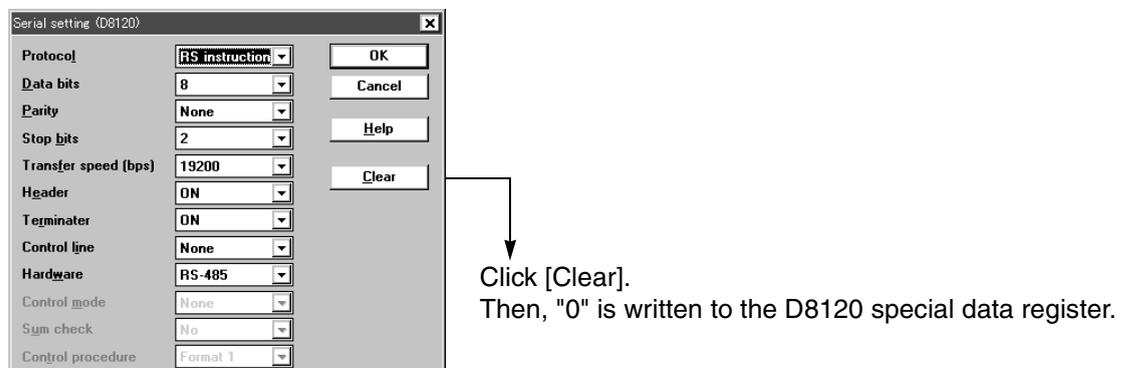

- After changing the setting, transfer the program and turn off the PLC power.  
The parameters are written into the special data register when the PLC is turned on.

### 8.3.4 Restrictions in connecting two or more F920GOT-K (5V type) units to FX Series PLC

This section explains the restrictions in connecting two or more F920GOT-K units to the programming port and the optional RS-422 expansion board (FX□N-422-BD).

These restrictions are not imposed on the 24V type F920GOT-K.

#### When connecting to FX1S/FX1N PLC

- One F920GOT-K can be connected to one PLC.
- The display module (FX1N-5DM or FX-10DM) cannot be used concurrently.

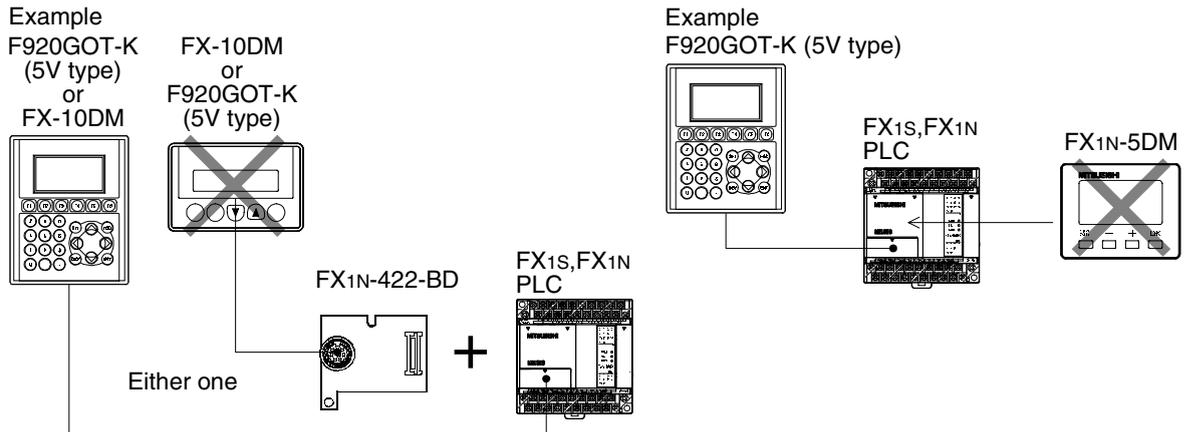

#### When connecting to FX2N PLC

- Up to two units can be connected using the FX2N-422-BD.
- Note, however, that the units are to be connected on the condition shown below (No special function block can be used).

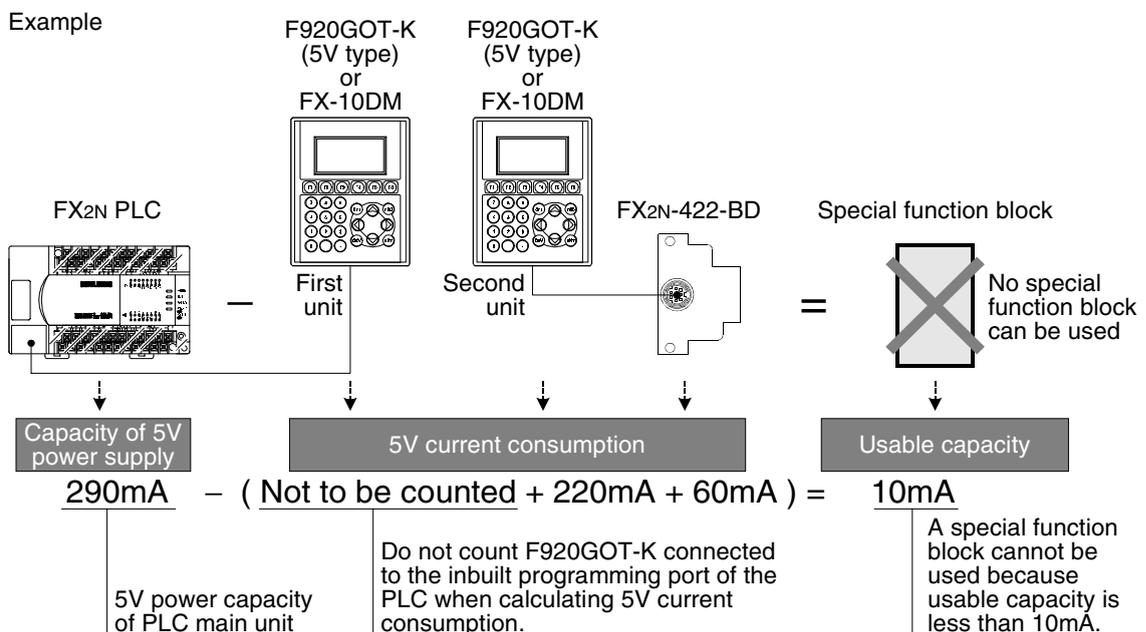

#### Unavailable combinations

The RS-422 expansion board cannot be used in the following combinations:

- FX1S, FX1N + FX1N-5DM + FX1N-422-BD + F920GOT-K
- FX1S, FX1N + F920GOT-K(or FX-10DM) + FX1N-422-BD + F920GOT-K(or FX-10DM)
- FX2N + Special function block + F920GOT-K(or FX-10DM) + FX2N-422-BD + F920GOT-K(or FX-10DM)

### 8.3.5 Connection to FX3U/FX3UC Series PLC

Do not use the following functions in the HPP mode when the GOT-F900 is connected to the FX3U/FX3UC Series PLC:

- Program list
- Parameter
- List monitor

When connecting the GOT-F900 to the FX3U/FX3UC Series PLC using the 2-port interface function, put a check mark in the check box [via GOT-F900 transparent mode] on the "Transfer Setup" dialog box of GX Developer.

If this check box is not selected, correct monitoring is not achieved.

Refer to "6.4.3 Cautions on connection to FX3U/FX3UC Series PLC" for the details.

1

Introduction

2

Outline

3

Specifications

4

Installation  
and Wiring of  
F940GOT

5

Installation  
and Wiring of  
Handy GOT

6

Connection of  
Peripheral  
Equipment

7

Connection of  
Two or More  
GOT Units

8

Connection of  
MELSEC-F FX  
Series PLC

9

Connection of  
MELSEC-A  
Series PLC

10

Connection of  
MELSEC-QnA  
Series PLC

## 8.4 Setting of Connected Equipment for GOT

The setting for connection to the FX Series PLC can be executed using the GOT-F900 and the screen creation software (GT Designer2, GT Designer or DU/WIN).

### 1) GOT-F900 Series

When the main menu screen change operation is disabled.

Operation	Display (screen name)
a) While pressing and holding the upper left corner of the screen, turn on the power. Keep holding the upper left corner for about 25 seconds more. Then, press "END" at the upper right corner.	The "LANGUAGE" screen appears.
b) Press "PLC TYPE".	The "SET-UP MODE" screen appears.
c) Set the following. PLC TYPE: FX SERIES CONNECTION: CPU PORT (RS-422) CPU PORT (RS-232C) DST STATION # (STATION #) : 00 GOT STATION # (-) : -	The "PLC TYPE" screen appears.

When the main menu screen change operation is enabled.

Operation	Display (screen name)
a) Press the upper left corner of the screen. (The position to be pressed can be changed in the GOT and the screen creation software.)	The "SELECT MODE" screen appears.
b) Press "OTHER MODE" on the menu.	The "OTHER MODE" screen appears.
c) Press "SET-UP MODE" on the menu.	The "SET-UP MODE" screen appears.
d) Press "PLC TYPE".	The "PLC TYPE" screen appears.
e) Set the following. PLC TYPE: FX SERIES CONNECTION: CPU PORT (RS-422) CPU PORT (RS-232C) DST STATION # (STATION #) : 00 GOT STATION # (-) : -	

- When the screen data is transferred to the GOT-F900, the old data including the PLC type, connection type, and station number are overwritten.

2) GT Designer2

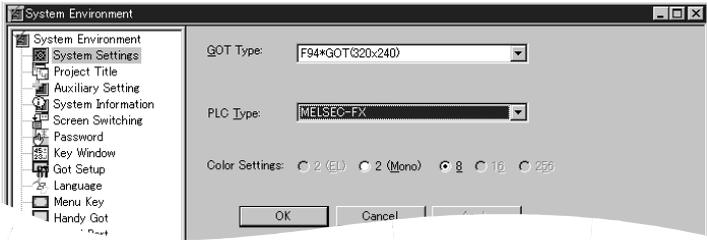
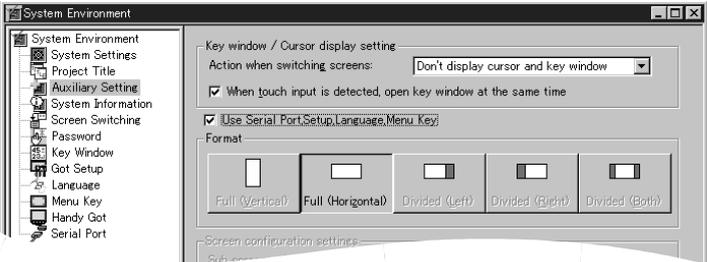
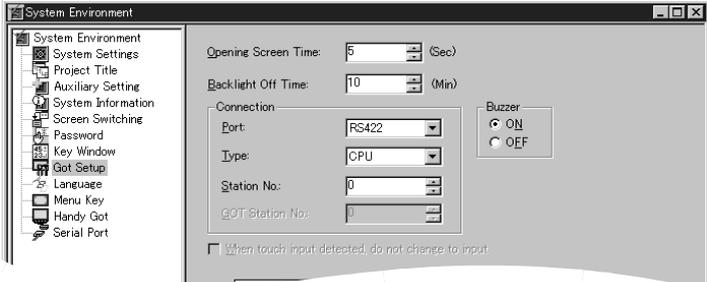
	Operation	Display (screen name)										
[Creation]	<p>a) Open GT Designer2.</p> <p>b) Click the [NEW] button. The dialog box shown below is displayed. If it is not displayed, click "System Environment" in the tree displayed in the project work space, then click "System Settings" in the tree.</p>  <p>c) Set the following. GOT type: F940WGOT (480 × 234) F94*GOT (320 × 240) F93*GOT (240 × 80) F920GOT (128 × 64) PLC type: MELSEC-FX Selection of "GOT type"</p> <table border="1" data-bbox="483 1003 1114 1263"> <thead> <tr> <th>GOT type</th> <th>Model name (name)</th> </tr> </thead> <tbody> <tr> <td>F940WGOT(480×234)&lt;WIDE&gt;</td> <td>F940WGOT</td> </tr> <tr> <td>F94*GOT(320×240)</td> <td>F940GOT Handy GOT</td> </tr> <tr> <td>F93*GOT(240×80)</td> <td>F930GOT F930GOT-K</td> </tr> <tr> <td>F920GOT(128×94)</td> <td>F920GOT-K</td> </tr> </tbody> </table> <p>Click [OK].</p> <p>d) Setting the port (RS-422 or RS-232C) of the GOT-F900 Click "Auxiliary Setting" in the tree of the system environment menu. Click the check box of "Use Serial Port, Setup, Language, Menu Key" to give a check mark (✓).</p>  <p>Click "GOT Setup" in the tree of the system environment menu.</p> 	GOT type	Model name (name)	F940WGOT(480×234)<WIDE>	F940WGOT	F94*GOT(320×240)	F940GOT Handy GOT	F93*GOT(240×80)	F930GOT F930GOT-K	F920GOT(128×94)	F920GOT-K	<p>The "Select Project" dialog box appears.</p> <p>The "System Environment" dialog box appears.</p> <p>The "Project Auxiliary Settings" dialog box appears.</p>
GOT type	Model name (name)											
F940WGOT(480×234)<WIDE>	F940WGOT											
F94*GOT(320×240)	F940GOT Handy GOT											
F93*GOT(240×80)	F930GOT F930GOT-K											
F920GOT(128×94)	F920GOT-K											

1	Introduction
2	Outline
3	Specifications
4	Installation and Wiring of F940GOT
5	Installation and Wiring of Handy GOT
6	Connection of Peripheral Equipment
7	Connection of Two or More GOT Units
8	Connection of MELSEC-F FX Series PLC
9	Connection of MELSEC-A Series PLC
10	Connection of MELSEC-QnA Series PLC

	Operation	Display (screen name)
	e)Set the following. Port : RS-422 RS-232C Type : CPU Station No. : 00 GOT Station No. : – <u>In the case of F943 Handy GOT</u> Without regard to the port setting (RS-422 or RS-232C), the COM0 side of the RS-232C is fixed for PLC connection.	
[Change method]	Change the connection type of the already created data as follows. a)Open GT Designer2. b)Click the [Project]-[Open] button. c)Open (read) the screen data to be changed. d)On the menu, select "Common"- "System Environment". - For the contents of setting, refer to c) of [Creation] above. - For selection of the RS-422 or the RS-232C on the FX Series, refer to e) of [Creation] above.	The "Select Project" dialog box appears.  The "System Environment" dialog box appears.



Operation		Display (screen name)
	e)Set the following. Port : RS-422 RS-232C Type : CPU DST Station No. (Station No.) : 00 GOT Station No. (-) : - <u>In the case of F943 Handy GOT</u> Without regard to the port setting (RS-422 or RS-232C), the COM0 side of the RS-232C is fixed for PLC connection.	
[Change method]	Change the connection type of the already created data as follows. a)Open GT Designer. b)Click the [Open] button. c)Open (read) the screen data to be changed. d)On the menu, select "Common"->"GOT/PLC Type". - For the contents of setting, refer to c) of [Creation] above. - For selection of the RS-422 or the RS-232C on the FX Series, refer to e) of [Creation] above.	The "Select Project" dialog box appears.  The "GOT/PLC Type" dialog box appears.

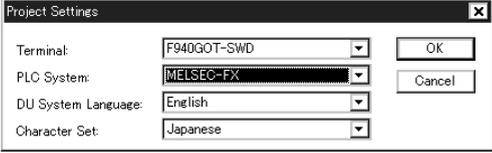
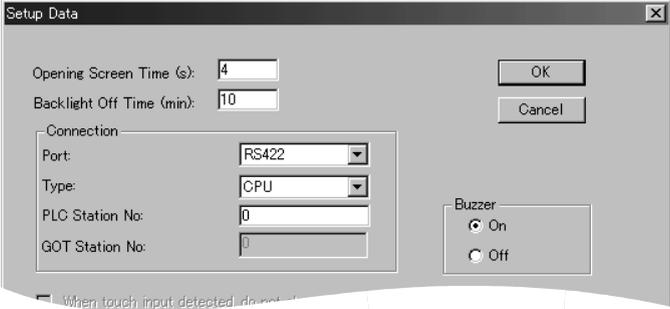

4) DU/WIN

Operation	Display (screen name)												
<p>[Creation]</p> <p>a) Open DU/WIN.</p> <p>b) On the menu, select "File"-"New".</p>  <p>c) Set the following.</p> <p>Terminal: F940WGOT-TWD (V) (H)            F940GOT-LWD            F940GOT-SWD            F930GOT-BWD (V) (H)            F920GOT-BBD5-K</p> <p>PLC System: MELSEC-FX</p> <p>Select "Terminal" in accordance with the LC display color.</p> <table border="1" data-bbox="464 817 1134 1144"> <thead> <tr> <th>Terminal</th> <th>Model name</th> </tr> </thead> <tbody> <tr> <td>F940WGOT-TWD (V)(H)</td> <td>F940WGOT (color)</td> </tr> <tr> <td>F940GOT-LWD</td> <td>F940GOT (black and white) Handy GOT (black and white)</td> </tr> <tr> <td>F940GOT-SWD</td> <td>F940GOT (color) Handy GOT (color)</td> </tr> <tr> <td>F930GOT-BWD (V)(H)</td> <td>F930GOT-K (blue) F930GOT (blue)</td> </tr> <tr> <td>F920GOT-BBD5-K</td> <td>F920GOT-K (blue)</td> </tr> </tbody> </table> <p>d) Set CPU direct (RS-422/RS-232C) of the GOT-F900.            On the menu, select "View/Project"-"System Settings"-"Setup Data".</p>  <p>e) Set the following.</p> <p>Port: RS-422            RS-232C</p> <p>Type: CPU</p> <p>DST Station No. (Station No.): 00            GOT Station No. (-) : -</p> <p><u>In the case of F943 Handy GOT</u>            Without regard to the port setting (RS-422 or RS-232C), the COM0 side of the RS-232C is fixed for PLC connection.</p>	Terminal	Model name	F940WGOT-TWD (V)(H)	F940WGOT (color)	F940GOT-LWD	F940GOT (black and white) Handy GOT (black and white)	F940GOT-SWD	F940GOT (color) Handy GOT (color)	F930GOT-BWD (V)(H)	F930GOT-K (blue) F930GOT (blue)	F920GOT-BBD5-K	F920GOT-K (blue)	<p>The "Project settings" dialog box appears.</p> <p>The "PLC" selection item display varies depending on the software version. In version 2.4 or later, "MELSEC-FX" is displayed instead of "FX".</p> <p>The "Setup Data" dialog box appears.</p>
Terminal	Model name												
F940WGOT-TWD (V)(H)	F940WGOT (color)												
F940GOT-LWD	F940GOT (black and white) Handy GOT (black and white)												
F940GOT-SWD	F940GOT (color) Handy GOT (color)												
F930GOT-BWD (V)(H)	F930GOT-K (blue) F930GOT (blue)												
F920GOT-BBD5-K	F920GOT-K (blue)												

1	Introduction
2	Outline
3	Specifications
4	Installation and Wiring of F940GOT
5	Installation and Wiring of Handy GOT
6	Connection of Peripheral Equipment
7	Connection of Two or More GOT Units
8	Connection of MELSEC-F FX Series PLC
9	Connection of MELSEC-A Series PLC
10	Connection of MELSEC-QnA Series PLC

Operation		Display (screen name)
[Change method]	<p>Change the connection type of the already created data as follows.</p> <p>a) Open DU/WIN.</p> <p>b) On the menu, select "File"-"Open".</p> <p>c) Select and open (read) the file of the screen data to be changed.</p> <p>d) When changing "Terminal" (GOT-F900), select "View/Project"-"System Settings"-"Project settings" on the menu. For the contents of setting, refer to c) in [Creation] above. For setting of RS-232C/RS-422 of the FX Series, refer to e) in [Creation] above.</p>	<p>The "Open" dialog box appears.</p> <p>The "Project settings" dialog box appears.</p>

## 8.5 Cable Diagram

This section explains cable diagrams to connect the GOT-F900 and the FX Series PLC.

### 8.5.1 Cautions on preparing cables

When preparing the cables, use the wire size of 0.08mm<sup>2</sup> or more (AWG28 or more) for communication, 0.3mm<sup>2</sup> or more (AWG22 or more) for the power supply, operation switch, and emergency stop switch. Do not use a twisted pair cable for the power supply wire and the communication wire.

### 8.5.2 Cable diagram

#### 1) Cable for the GOT and the FX Series PLC

F920GOT-K (5V type)

 : Female type  : Male type The connector figure shows the engagement face.

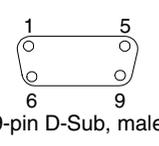
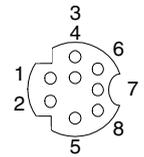
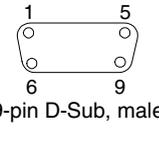
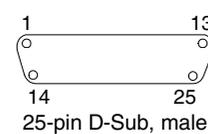
No.	Model name	Application	Connection diagram	Application
a)	<div style="border: 1px solid black; padding: 2px; display: inline-block;">RS-422 connection</div> FXCPU direct connection FX-50DU-CAB0 FX-50DU-CAB0/EN FX-50DU-CAB0-1M	To GOT-F900		To FX0/FX0s/FX1s/ FX0N/FX1N/FX2N/FX3U/ FX2NC/FX3UC 
b)	<div style="border: 1px solid black; padding: 2px; display: inline-block;">RS-422 connection</div> FXCPU direct connection Prepared by the user (Cable length 3m(9'10") or less)  Resistance per wire: 0.67 Ω or less (Approximately AWG 28 or thicker)	To GOT-F900		To FX/FX2c 

The cable length must be 3m (9'10") or less when used for the F920GOT-K.

1	Introduction
2	Outline
3	Specifications
4	Installation and Wiring of F940GOT
5	Installation and Wiring of Handy GOT
6	Connection of Peripheral Equipment
7	Connection of Two or More GOT Units
8	Connection of MELSEC-F FX Series PLC
9	Connection of MELSEC-A Series PLC
10	Connection of MELSEC-QnA Series PLC

F920GOT-K (24V type)/F930GOT/F930GOT-K/F940GOT/F940WGOT

 : Female type  : Male type The connector figure shows the engagement face.

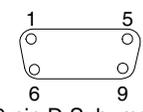
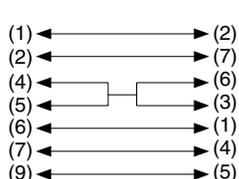
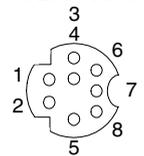
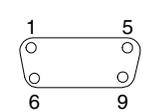
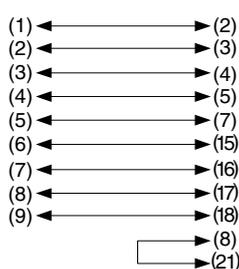
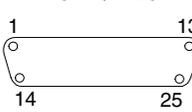
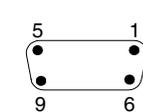
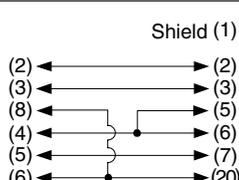
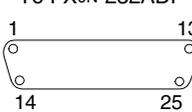
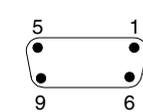
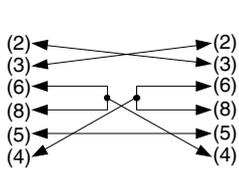
No.	Model name	Application	Connection diagram	Application
a)	<p><b>FXCPU direct connection</b></p> <p><b>RS-422 connection</b></p> <p>FX-50DU-CAB0 FX-50DU-CAB0/EN FX-50DU-CAB0-1M FX-50DU-CAB0-10M FX-50DU-CAB0-20M FX-50DU-CAB0-30M FX-50DU-CAB0L</p>	<p>To GOT-F900</p>  <p>9-pin D-Sub, male</p>		<p>To FX0/FX0s/FX1s/ FX0N/FX1N/FX2N/FX3U/ FX2NC/FX3UC</p>  <p>8-pin MINI DIN, male</p>
b)	<p><b>FXCPU direct connection</b></p> <p><b>RS-422 connection</b></p> <p>FX-40DU-CAB FX-40DU-CAB-10M FX-40DU-CAB-20M FX-40DU-CAB-30M FX-50DU-CABL</p>	<p>To GOT-F900</p>  <p>9-pin D-Sub, male</p>		<p>To FX/FX2c</p>  <p>25-pin D-Sub, male</p>
c)	<p><b>FXCPU direct connection</b></p> <p><b>RS-232C connection</b></p> <p>F2-232CAB-1</p>	<p>To GOT-F900</p>  <p>9-pin D-Sub, female</p>		<p>To FX0N-232ADP</p>  <p>25-pin D-Sub, male</p>
d)	<p><b>FXCPU direct connection</b></p> <p><b>RS-232C connection</b></p> <p>FX-232CAB-1</p>	<p>To GOT-F900</p>  <p>9-pin D-Sub, female</p>		<p>To FX1N-232-BD, FX2N-232-BD, FX3U-232-BD, FX2NC-232ADP, FX3U-232ADP</p>  <p>9-pin D-Sub, female</p>

2) Cable for the Handy GOT and the FX Series PLC

When using the Handy GOT RH model, refer to the cable diagrams below for the RS-422/RS-232C connector, but not the wiring for the power supply, the operation switches, and the emergency stop switch because it is different. For details, refer to Section 5.18.

: Female type : Male type The connector figure shows the engagement face.

No.	Model name	Application	Connection diagram	Application
a)	F9GT-HCAB-3M F9GT-HCAB-10M	RS-422 connection RS-232C connection Dedicated connector on Handy GOT side	The connector on the leader side of the Handy GOT is dedicated, and cannot be prepared by the user.	To F9GT-HCAB2-150 or F9GT-HCAB3-150  25-pin D-Sub, male
b)	F9GT-HCAB1-3M F9GT-HCAB1-10M	RS-422 connection RS-232C connection Dedicated connector on Handy GOT side	The connector on the leader side of the Handy GOT is dedicated, and cannot be prepared by the user.	Loose wires (no connector)
c)	F9GT-HCAB2-150	RS-422 connection To cable F9GT-HCAB on Handy GOT side  25-pin D-Sub, female	Wiring according to the pin number of F9GT-HCAB-□□M Drain wire (1) → FG (Grounding) BK (2) → (2) W (3) → (1) Y (6) → (7) BR (7) → (4) BL (8) → (6) GY (9) → (5) O (10) → (3) SHELL PL (12) → DC24VG PK (13) → DC24VG LTGR (14) → SW-COM / ES1-2 SB (15) → SW1 / DSW2 BK/W (16) → SW2 / DSW2 R/W (17) → SW3 / DSW1 GR/W (18) → SW4 / DSW1 O/W (20) → / ES1-2 Y/W (21) → ES1 / ES1-1 BR/W (22) → ES1 / ES1-1 BL/W (24) → DC24V+ GY/W (25) → DC24V+ Wiring according to the wire color of F9GT-HCAB1-□□M	To FX0/FX0S/FX1S/ FX0N/FX1N/FX2N/FX3U/ FX2N/FX3UC  8-pin MINI DIN, male Wire the power supply, the operation switches and the emergency stop switch. Old cable description New cable description
d)	F9GT-HCAB3-150	RS-422 connection To cable F9GT-HCAB on Handy GOT side  25-pin D-Sub, female	Wiring according to the pin number of F9GT-HCAB-□□M Drain wire (1) → FG (Grounding) BK (2) → (2) W (3) → (15) GR (4) → (4) Y (6) → (3) BR (7) → (16) BL (8) → (5) GY (9) → (18) O (10) → (7) Hood (8) (21) PL (12) → DC24VG PK (13) → DC24VG LTGR (14) → SW-COM / ES1-2 SB (15) → SW1 / DSW2 BK/W (16) → SW2 / DSW2 R/W (17) → SW3 / DSW1 GR/W (18) → SW4 / DSW1 O/W (20) → / ES1-2 Y/W (21) → ES1 / ES1-1 BR/W (22) → ES1 / ES1-1 BL/W (24) → DC24V+ GY/W (25) → DC24V+ Wiring according to the wire color of F9GT-HCAB1-□□M	To FX/FX2C  25-pin D-Sub, male Wire the power supply, the operation switches and the emergency stop switch. Old cable description New cable description

1	Introduction
2	Outline
3	Specifications
4	Installation and Wiring of F940GOT
5	Installation and Wiring of Handy GOT
6	Connection of Peripheral Equipment
7	Connection of Two or More GOT Units
8	Connection of MELSEC-F FX Series PLC
9	Connection of MELSEC-A Series PLC
10	Connection of MELSEC-QnA Series PLC

 : Female type  : Male type The connector figure shows the engagement face.

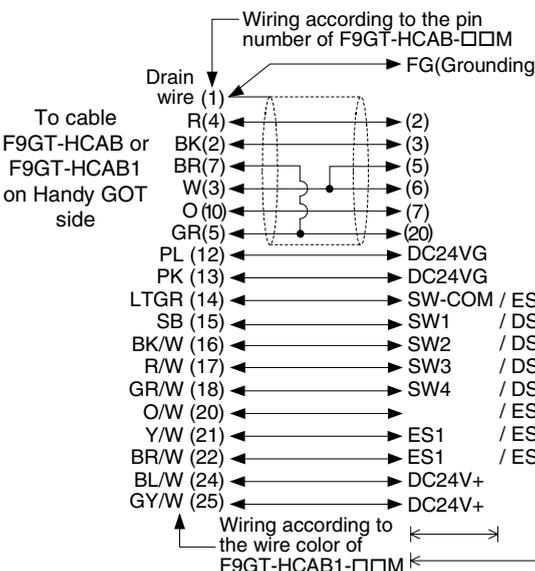
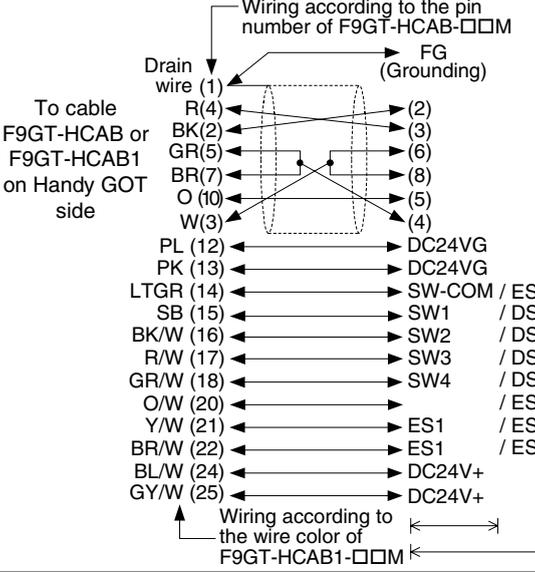
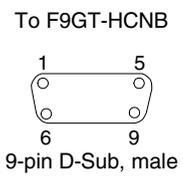
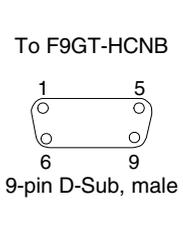
No.	Model name	Application	Connection diagram	Application
e)	Prepared by the user	RS-232C connection	<p>Wiring according to the pin number of F9GT-HCAB-□□M</p>  <p>To cable F9GT-HCAB or F9GT-HCAB1 on Handy GOT side</p> <p>To FX0N-232ADP 1 13 14 25 25-pin D-Sub, male</p> <p>Wire the power supply, the operation switches and the emergency stop switch.</p> <p>Old cable description → New cable description</p>	
f)	Prepared by the user	RS-232C connection	<p>Wiring according to the pin number of F9GT-HCAB-□□M</p>  <p>To cable F9GT-HCAB or F9GT-HCAB1 on Handy GOT side</p> <p>To FX1N-232-BD, FX2N-232-BD, FX3U-232-BD, FX2NC-232ADP, FX3U-232ADP 5 1 9 6 9-pin D-Sub, female</p> <p>Wire the power supply, the operation switches and the emergency stop switch.</p> <p>Old cable description → New cable description</p>	
g)	FXCPU direct connection FX-50DU-CAB0 FX-50DU-CAB0-1M	RS-422 connection	<p>To F9GT-HCNB</p>  <p>9-pin D-Sub, male</p> <p>To FX0/FX0S/FX1S/ FX0N/FX1N/FX2N/FX3U/ FX2NC/FX3UC 3 4 6 7 8 5 8-pin MINI DIN, male</p>	
h)	FXCPU direct connection FX-40DU-CAB	RS-422 connection	<p>To F9GT-HCNB</p>  <p>9-pin D-Sub, male</p> <p>To FX/FX2c Series 1 13 14 25 25-pin D-Sub, male</p>	

## 8.6 Troubleshooting

For reference, this section summarizes frequently asked questions about connection of the GOT-F900 to the FX Series PLC.

The slightly different messages may be displayed on the F920GOT-K.

### 1) GOT-F900

Contents of trouble	Check points and countermeasures	OS version			
		F940W	F940	F930	F920
<p>"COMMUNICATION ERROR OCCURS" is displayed when a screen changeover or numeric data input is performed on the GOT-F900 screen by a touch key *1.</p> <p>*1 No touch key is available on the F920GOT-K.</p>	<p>The power of the FX Series PLC is turned off.</p> <ul style="list-style-type: none"> <li>• Cause Communication is disabled because the power of the FX Series PLC is turned off.</li> <li>• Countermeasures Turn on the power.</li> </ul> <p>Something is wrong with the cable between the GOT-F900 and the FX Series PLC.</p> <ul style="list-style-type: none"> <li>• Causes The wrong cable is used or the connection is bad.</li> <li>• Countermeasures Check the cable.</li> </ul>	From first product	From first product	From first product	From first product
<p>"DISPLAY SCREEN IS NOT AVAILABLE." is displayed on the GOT-F900 screen.</p>	<p>Changeover to a nonexistent screen by a touch key or the FX Series PLC was tried.</p> <ul style="list-style-type: none"> <li>• Cause The changeover destination screen has not been created yet.</li> <li>• Countermeasures Create the screen.</li> </ul>	–	Earlier than 6.00	Earlier than 4.00	–
<p>"DISPLAY SCREEN IS NOT AVAILABLE. (NO. #####)" is displayed on the GOT-F900 screen.</p>	<p>A nonexistent screen was tried to be displayed.</p> <ul style="list-style-type: none"> <li>• Cause The screen No. ##### has not been created yet.</li> <li>• Countermeasures Create the screen.</li> </ul>	From first product	6.00 or later	4.00 or later	From first product

1	Introduction
2	Outline
3	Specifications
4	Installation and Wiring of F940GOT
5	Installation and Wiring of Handy GOT
6	Connection of Peripheral Equipment
7	Connection of Two or More GOT Units
8	Connection of MELSEC-F FX Series PLC
9	Connection of MELSEC-A Series PLC
10	Connection of MELSEC-QnA Series PLC

Contents of trouble	Check points and countermeasures	OS version			
		F940W	F940	F930	F920
"DISPLAY SCREEN IS NOT AVAILABLE." is displayed on the GOT-F900 screen.	<p>A device that does not exist in the FX Series PLC was referenced. (Example: While an FX0s Series PLC is connected, a device exists only in the FX2N Series PLC is specified for numeric input.)</p> <ul style="list-style-type: none"> <li>• Cause On the changeover destination screen (excluding the head screen), a nonexistent device in the connected FX Series PLC is specified.</li> <li>• Countermeasures Check the devices used on the head screen.</li> </ul>				
	<p>When a PLC is not connected, the GOT defaults to the FX-**M*-** mode.</p> <ul style="list-style-type: none"> <li>• Cause Check for the FX-**M*-** or FX2N Series was executed, the connection mode was automatically changed over, then the device range was checked. This error occurs when the device range set on the changeover destination screen (excluding the head screen) is beyond the range for the FX-**M*-** Series.</li> <li>• Countermeasures Connect the PLC.</li> </ul>	–	Earlier than 6.00	Earlier than 4.00	–
	<p>There is an error on the screen to be displayed.</p> <ul style="list-style-type: none"> <li>• Cause One of the screen objects is placed outside the available screen area.</li> <li>• Countermeasures Check the placement of screen objects.</li> </ul>				
"DISPLAY SCREEN IS NOT AVAILABLE. (NO. #####)" is displayed on the GOT-F900 screen.	<p>The display screen contains an error.</p> <ul style="list-style-type: none"> <li>• Causes A device that does not exist in the connected PLC is referenced on the screen No. #####, or one of the screen objects is placed outside the available screen area.</li> <li>• Countermeasures Check the devices used and placement of screen objects.</li> </ul>	From first product	6.00 or later	4.00 or later	From first product



Contents of trouble	Check points and countermeasures	OS version			
		F940W	F940	F930	F920
"DATA IS NOT FOUND." is displayed on the GOT-F900 screen.	<p>There is not data because the unit is new or the memory clear has been executed.</p> <ul style="list-style-type: none"> <li>• Cause There is no screen data.</li> <li>• Countermeasures Write the screen data using the screen creation software.</li> </ul>				
	<p>A device that does not exist in the FX Series PLC was referenced. (Example: While an FX0s Series PLC is connected, a device exists only in the FX-**M**-** Series PLC is specified for numeric input.)</p> <ul style="list-style-type: none"> <li>• Cause On the head screen, a nonexistent device in the connected FX Series PLC is specified. (The head screen is the screen No. 1 in the GT Designer, and the screen No. 0 in the DU/WIN.)</li> <li>• Countermeasures Check the devices used on the head screen.</li> </ul>	-	Earlier than 6.00	Earlier than 4.00	-
	<p>While the FX Series PLC is not connected, the connection mode for the FX-**M**-** Series PLC is selected.</p> <ul style="list-style-type: none"> <li>• Cause Check for the FX-**M**-** or FX2N Series was executed, the connection mode was automatically changed over, then the device range was checked. This error occurs when the device range set on the head screen is beyond the range for the FX2 Series. (The head screen is the screen No. 1 in the GT Designer, and the screen No. 0 in the DU/WIN.)</li> <li>• Countermeasures Connect the PLC.</li> </ul>				
	<p>There is not data because the unit is new or the memory clear has been executed.</p> <ul style="list-style-type: none"> <li>• Cause There is no screen data.</li> <li>• Countermeasures Write the screen data using the screen creation software.</li> </ul>	From first product	6.00 or later	4.00 or later	From first product
"CAN NOT WRITE TO PLC MEMORY." is displayed on the GOT-F900 screen.	<p>Programs and device set values of the FX Series PLC cannot be changed.</p> <ul style="list-style-type: none"> <li>• Causes The write-protect switch of the memory cassette is set to ON. PLC Password protection is on.</li> <li>• Countermeasures Set the write-protect switch to OFF. Enter the keywords by "SELECT MODE"- "OTHER MODE"- "ENTRY CODE".</li> </ul>	Earlier than 1.10	Earlier than 6.10	Earlier than 4.10	-

- 1 Introduction
- 2 Outline
- 3 Specifications
- 4 Installation and Wiring of F940GOT
- 5 Installation and Wiring of Handy GOT
- 6 Connection of Peripheral Equipment
- 7 Connection of Two or More GOT Units
- 8 Connection of MELSEC-F FX Series PLC
- 9 Connection of MELSEC-A Series PLC
- 10 Connection of MELSEC-QnA Series PLC

Contents of trouble	Check points and countermeasures	OS version			
		F940W	F940	F930	F920
"CAN NOT WRITE." is displayed on the GOT-F900 screen.	<p>Programs and device set values of the FX Series PLC cannot be changed.</p> <ul style="list-style-type: none"> <li>• Causes The write-protect switch of the memory cassette is set to ON. PLC Password protection is on.</li> <li>• Countermeasures Set the write-protect switch to OFF. Enter the keywords by "SELECT MODE"- "OTHER MODE"- "ENTRY CODE".</li> </ul>	1.10 or later	6.10 or later	4.10 or later	From first product
"CAN NOT USE THE FUNCTION WHILE PROTECTED." is displayed on the GOT-F900 screen.	<p>Programs and device set values of the FX Series PLC cannot be changed.</p> <ul style="list-style-type: none"> <li>• Causes PLC Password protection is on.</li> <li>• Countermeasures Enter the keywords by "SELECT MODE"- "OTHER MODE"- "ENTRY CODE".</li> </ul>	From first product	From first product	From first product	From first product
"PLC IS RUNNING." is displayed on the GOT-F900 screen.	<p>An attempt was made to edit the set value of the timer or counter, or the current value of the file registers of the FX Series PLC.</p> <ul style="list-style-type: none"> <li>• Cause Such changes are disabled while the FX Series PLC equipped with the EEPROM memory cassette is running. (Data saved in the built-in EEPROM can be changed.) Such changes are also disabled when the PLC is equipped with EPROM memory cassette.</li> <li>• Countermeasures Run the FX Series PLC using the built-in memory. Specify the set value of the timer (T) and the counter (C) indirectly through the data register (D).</li> </ul>	From first product	From first product	From first product	From first product

2) Software

	Contents of trouble	Check points and countermeasures
Software such as GX Developer and FX/WIN	In the personal computer connected to the GOT-F900, sequence programs cannot be monitored or transferred. Communication with the sequence software is disabled. An error message is displayed.	<p>A PLC, bar code reader or printer is connected.</p> <ul style="list-style-type: none"> <li>• Causes The RS-232C connector to which the personal computer is connected is set to be used for another piece of equipment.</li> <li>• Countermeasures For monitoring or transferring sequence programs, set a bar code reader to invalid and a printer to "DON'T USE". If the PLC is connected, select the GOT-F900 equipped with two built-in RS-232C channels.</li> </ul> <hr/> <p>Something is wrong with the cable between the GOT-F900 and the personal computer.</p> <ul style="list-style-type: none"> <li>• Causes The wrong cable is used or the connection is bad.</li> <li>• Countermeasures Check the cable.</li> </ul>
Screen creation software	In the personal computer connected to the GOT-F900, screen data cannot be transferred. Communication with the screen creation software is disabled. An error message is displayed.	<p>A PLC, bar code reader or printer is connected.</p> <ul style="list-style-type: none"> <li>• Causes The RS-232C connector to which the personal computer is connected is set to be used for another piece of equipment.</li> <li>• Countermeasures In the GOT-F900, select by hand "SELECT MODE"-"OTHER MODE"-"DATA TRANSFER". Or set a bar code reader to invalid and a printer to "DON'T USE".</li> </ul> <hr/> <p>A personal computer is connected, and the software for PLC (such as GPP/W and FX/WIN) and the screen creation software are used at the same time.</p> <ul style="list-style-type: none"> <li>• Cause Program transfer or monitoring is executed by the software for PLC.</li> <li>• Countermeasures Terminate program transfer or monitoring by the PLC software. If the error status still continues, shut down the PLC. Otherwise, shut down the personal computer, start it up again, then start up only the screen creation software.</li> </ul> <hr/> <p>Something is wrong with the cable between the GOT-F900 and the personal computer.</p> <ul style="list-style-type: none"> <li>• Causes The connected cable is not proper. Or cable connection is not correct.</li> <li>• Countermeasures Check the cable.</li> </ul>

1	Introduction
2	Outline
3	Specifications
4	Installation and Wiring of F940GOT
5	Installation and Wiring of Handy GOT
6	Connection of Peripheral Equipment
7	Connection of Two or More GOT Units
8	Connection of MELSEC-F FX Series PLC
9	Connection of MELSEC-A Series PLC
10	Connection of MELSEC-QnA Series PLC

# MEMO

## 9. Connection of MELSEC-A Series PLC

This chapter explains connection of the GOT-F900 Series display unit to the CPU unit or the computer link unit of the A Series PLC.

The same procedure is taken when connecting to the CPU of the motion controller (in which CPU direct connection is available).

### Connection Procedure

This section introduces the procedure to connect the GOT-F900 to the A Series PLC.

#### 1. Preparation

Item name	Description	Reference
System Condition	You can learn the connection availability as well as the version of the GOT-F900 OS and the screen creation software.	9.1
System Configuration	You can select the configuration between the GOT and the A Series PLC/computer link unit as well as proper cables.	9.2

#### 2. Setting

Item name	Description	Reference
ACPU Selection in Direct Connection	In the A computer link, the following setting is required. When A connection is selected, the GOT-F900 is automatically set to fixed values. No setting is required in the A Series PLC.	–
Setting in A Computer Link Connection	You can learn the communication specifications and the setting.	
	Setting of A computer link	The contents of setting of computer link 9.3.1
	Setting of CD signal control	The setting method in which CD signals are not checked in the sequence program in RS-232C connection 9.3.2
	Setting examples	Switch setting in each computer link 9.3.3
Caution on Use of MELSEC-A Series PLC	You can learn the restrictions in connecting the GOT to the A Series PLC.	9.4
Setting of Connected Equipment for GOT	Set the PLC type using the GOT or the screen creation software.	9.5

#### 3. Others

Item name	Description	Reference
Cable Diagram	Cable diagrams for A Series PLC/GOT connection	9.6
Troubleshooting	Description of errors and how to fix them	9.7

## 9.1 System Condition

When connecting the A Series PLC, check the COM port designation, the OS version of the GOT-F900, and the applicable version of the screen creation software.

Compatibility when connecting A Series PLC

GOT-F900 Series	COM port		Connection type		OS version of GOT-F900	Version of screen creation software		
	RS-422	RS-232C	1:1	Two or more GOT units		GT Designer2	GT Designer	DU/WIN
F920GOT-K(5V)	△	–	✓	–	1.00	SW1-C	SW5-26C	2.70
F920GOT-K(24V)	✓	✓	✓	–	1.20	SW1-C	–	–
F930GOT	✓	✓	✓	△	1.00	SW1-C	SW1-H	2.20
F930GOT-K	✓	✓	✓	△	4.60	SW1-C	SW5-26C	2.70
F940GOT	✓	✓	✓	△	1.00	SW1-C	SW1-A	2.00
F940WGOT	✓	✓	✓	△	1.00	SW1-C	SW5-F	2.50
F940 Handy GOT	✓	–	✓	△ <sup>*1</sup>	1.00	SW1-C	SW1-D	2.10
F943 Handy GOT	–	✓	✓	△ <sup>*1</sup>	1.00	SW1-C	SW1-D	2.10

- "△" in the table indicates that only CPU direct connection is available, and computer link connection is not available.

- The screen creation software version corresponds to the model of the GOT-F900 Series. Refer to section 3.2.

\*1 The RS-232C port for the Handy type GOT is provided inside the rear cover. As a result, environmental protection is lost when using this port and such a connection is not practical. (The Handy GOT can be connected as the final unit in a string of two or more GOTs.)

## 9.2 System Configuration

The A Series PLC can be connected to the GOT through a computer link connection (RS-422 or RS-232C) or directly via RS-422. This section explains the cables and options required in such a system. In CPU direct connection, two or more GOT units can be connected.

### 9.2.1 Applicable model

The GOT-F900 can be connected to the following equipment in accordance with its OS version. Operations are not assured when the GOT-F900 is connected to any other equipment. For details of the OS version of the GOT-F900 and applicable equipment, refer to "3.1 OS Version and Correspondence to Connected Equipment of GOT-F900".

CPU	OPTION	COMMUNICATION PORT
AnN CPU AnA CPU AnS CPU AnSJ CPU AnSH CPU A1SJH CPU A2C CPU A2CJ CPU A0J2H CPU AnU CPU AnUS CPU A2USH CPU A1FX CPU	–  A1SJ71C24-R4 A1SJ71C24-R2 A1SJ71UC24-R4 A1SJ71UC24-R2 A1SCPUC24-R2 AJ71UC24 A2CCPUC24	Connection to programming port  Connection to computer link unit (Excluding the 5V type F920GOT-K.)
A171SCPU-S3 A171SHCPU A172SHCPU A173UHCPU A273UHCPU	–	Connection to computer link unit (excluding the F920GOT-K)

1

Introduction

2

Outline

3

Specifications

4

Installation  
and Wiring of  
F940GOT

5

Installation  
and Wiring of  
Handy GOT

6

Connection of  
Peripheral  
Equipment

7

Connection of  
Two or More  
GOT Units

8

Connection of  
MELSEC-F  
FX Series PLC

9

Connection of  
MELSEC-A  
Series PLC

10

Connection of  
MELSEC-QnA  
Series PLC

### 9.2.2 Configuration for Direct Connection (RS-422)

Connect the GOT-F900 to the programming port of the A Series PLC.

Program transfer and monitoring are available in the GOT-F900 Series using the built-in two-port interface function through connection of a personal computer to the RS-232C port. (excluding the F920GOT-K)

When using the GX Developer, however, pay attention to the GOT-F900 OS version. (Refer to 6.6.)

#### 1) F920GOT-K/F930GOT/F930GOT-K/F940GOT/F940WGOT

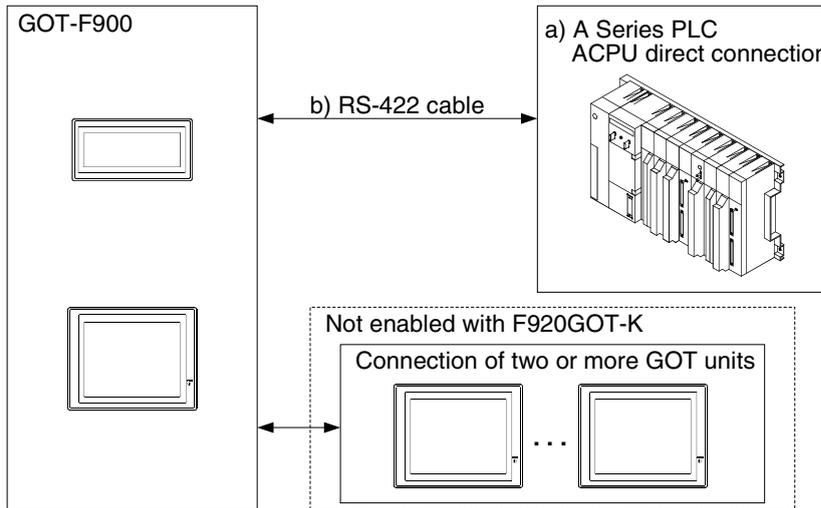

#### F920GOT-K

a) A Series PLC	b) RS-422 cable	Remarks
ACPU direct connection (25-pin D-Sub)	Prepared by the user.	Make sure the total cable extension distance is 3m (9' 10") or less.

#### F930GOT/F930GOT-K/F940GOT/F940WGOT

a) A Series PLC	b) RS-422 cable	Remarks
ACPU direct connection (25-pin D-Sub)	FX-40DU-CAB FX-40DU-CAB-□□M FX-50DU-CABL	"□□" in "FX-40DU-CAB-□□M" indicates the cable length.

- Only one of the cables listed in column b) is required for connection.
- In the F930GOT and the F930GOT-K, the FX-50DU-CABL right-angle type (L type) cable can not be used.



2) F940 Handy GOT

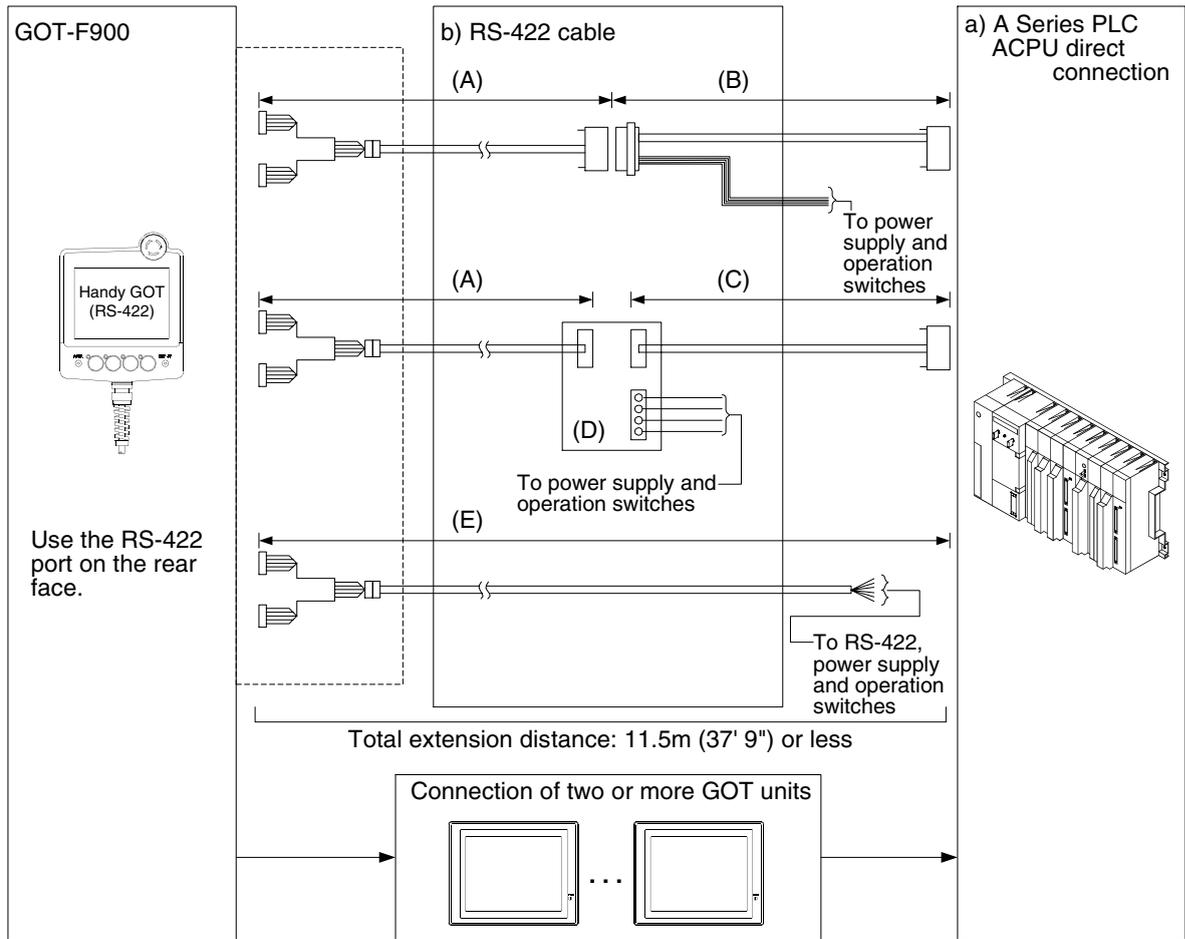

a) A Series PLC	b) RS-422 cable	Remarks
ACPU direct connection (25-pin D-Sub)	(A) F9GT-HCAB-□□M (B) F9GT-HCAB3-150 (C) FX-40DU-CAB (D) F9GT-HCNB (E) F9GT-HCAB1-□□M	

- Make sure that the total cable extension distance "(A) + (B)" or (E) is 11.5m (37' 9") or less.

1	Introduction
2	Outline
3	Specifications
4	Installation and Wiring of F940GOT
5	Installation and Wiring of Handy GOT
6	Connection of Peripheral Equipment
7	Connection of Two or More GOT Units
8	Connection of MELSEC-F Series PLC
9	Connection of MELSEC-A Series PLC
10	Connection of MELSEC-QnA Series PLC

**9.2.3 Configuration for A Computer Link Connection (RS-422)**

The GOT-F900 and the computer link unit can be connected on the "1:1" basis. Because the programming port of the PLC is not occupied, peripheral programming equipment (dedicated equipment) for PLC can be connected for monitoring and transfer of sequence programs.

**1) F920GOT-K (24V type)/F930GOT/F930GOT-K/F940GOT/F940WGOT**

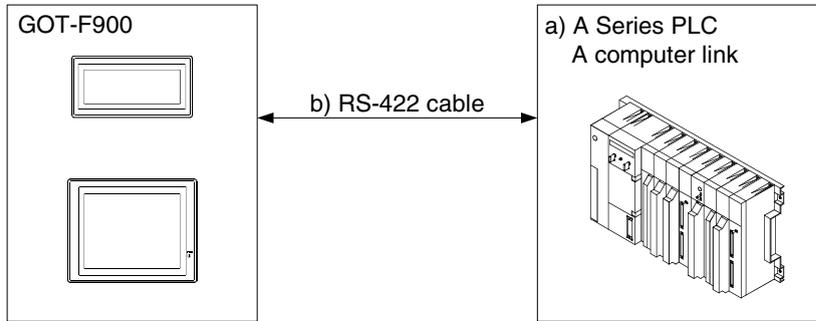

a) A Series PLC		b) RS-422 cable	Remarks
AJ71UC24			Make sure the total cable extension distance is 30m (98' 5") or less.
A1SJ71C24-R4	Terminal block	Prepared by the user.	
A1SJ71UC24-R4			

- Applicable A Series PLC products in the column a) are computer link units equipped with built-in RS-422 interface.
- Connect the terminating resistors on the computer link unit side.

2) F940 Handy GOT

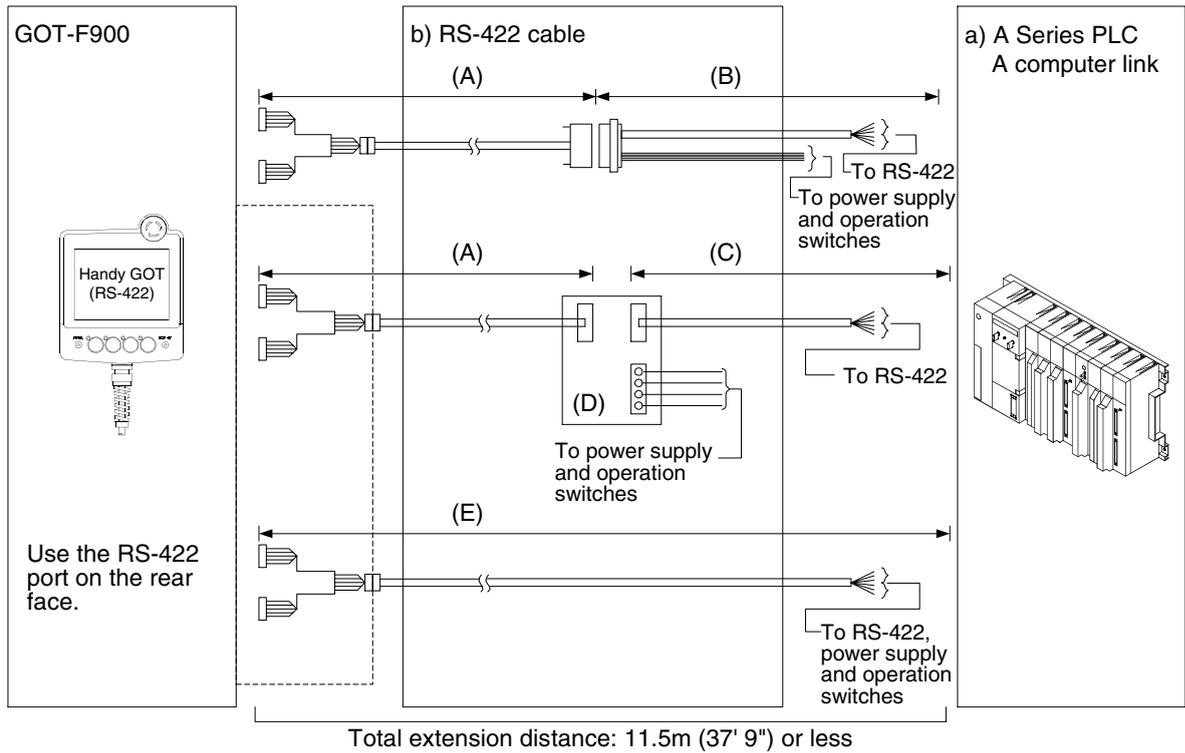

a) A Series PLC		b) RS-422 cable	Remarks
AJ71UC24	Terminal block	(A) F9GT-HCAB-□□M	Make sure the total cable extension distance is 11.5m (37' 9") or less.
A1SJ71C24-R4		(B) Prepared by the user.	
A1SJ71UC24-R4		(C) Prepared by the user.	
		(D) F9GT-HCAB	
		(E) F9GT-HCAB1-□□M	

- Applicable A Series PLC products in the column a) are computer link units equipped with built-in RS-422 interface.
- Make sure that the total cable extension distance "(A) + (B)" or (E) is 11.5m (37' 9") or less.
- Connect the terminating resistors on the computer link unit side.

1	Introduction
2	Outline
3	Specifications
4	Installation and Wiring of F940GOT
5	Installation and Wiring of Handy GOT
6	Connection of Peripheral Equipment
7	Connection of Two or More GOT Units
8	Connection of MELSEC-F FX Series PLC
9	Connection of MELSEC-A Series PLC
10	Connection of MELSEC-QnA Series PLC

9.2.4 Configuration for A Computer Link Connection (RS-232C)

The GOT-F900 and the computer link unit can be connected on the "1:1" basis. Because the programming connector of the PLC is not occupied, peripheral programming equipment (dedicated equipment) for PLC can be connected for monitoring and transfer of sequence programs.

1) F920GOT-K (24V type)/F930GOT/F930GOT-K/F940GOT/F940WGOT

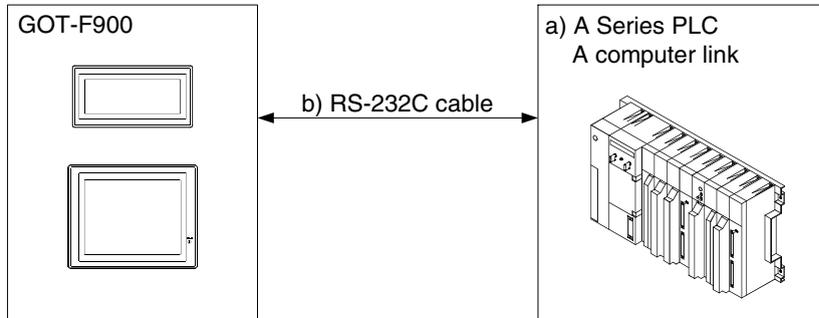

a) A Series PLC		b) RS-232C cable	Remarks
A1SJ71C24-R2 A1SJ71UC24-R2 A1SCPUC24-R2 A2CCPUC24	9-pin D-Sub	Prepared by the user.	Make sure the total cable extension distance is 15m (49' 3") or less.
AJ71UC24	25-pin D-Sub	F2-232CAB-1	

- Applicable A Series PLC products in the column a) are computer link units equipped with built-in RS-232C interface.

2) F943 Handy GOT

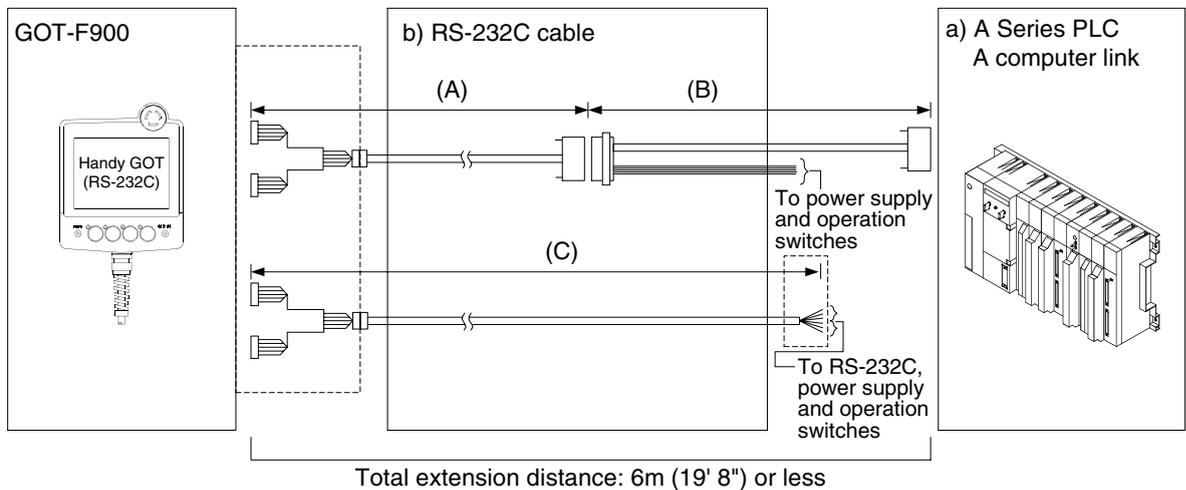

a) A Series PLC		b) RS-232C cable	Remarks
A1SJ71C24-R2 A1SJ71UC24-R2 A2CCPUC24 A1SCPUC24-R2	9-pin D-Sub	(A) F9GT-HCAB-3M (B) Prepared by the user. (C) F9GT-HCAB1-3M	
AJ71UC24	25-pin D-Sub		

- In the (C)F9GT-HCAB1-3M shown in the column "b) RS-232C cable", the end on the PLC side is loose wires.

- Make sure that the total cable extension distance "(A) + (B)" or (C) is 6m (19' 8") or less.

## 9.3 Setting in A Computer Link Connection

In A computer link connection, the switches in the computer link unit (shown in the following page) should be set as described below.

### 9.3.1 Communication Setting Specifications

#### 1) Setting the mode selector switch

Set the mode so that the COM port of the computer link unit connected to the GOT-F900 is set to the dedicated protocol format 1.

COM port	Set value	Remarks
RS-422	5	RS-422: Format 1 RS-232C: No protocol
RS-232C	1	RS-422: No protocol RS-232C: Format 1

#### 2) Setting the transmission specifications setting switches

Set the transmission specifications setting switches of the computer link unit to realize the transmission specifications shown in the table below.

Item	Set value	Remarks
Transmission speed	19,200 bps	
Data format	Data bit	7 bits
	Parity bit	Provided (even)
	Stop bit	1 bit
	Sum check	Provided
Write in RUN mode	Possible	

- The specifications such as the transmission speed are fixed on the GOT-F900 side, and cannot be changed.

#### 3) Setting the station number setting switches

Match the switches to the value set in the GOT-F900 (0 to 15).

(In some computer link units, the switches should be set in the range from 0H to FH.)

#### 4) Turning on the power again

After setting the A computer link, make sure to turn off the power once, then turn it on again.

(Even if the RESET switch in the ACPU is pressed, the changed setting does not become valid.)

### 9.3.2 Setting of CD Signal Control (only in RS-232C connection)

When the GOT-F900 and the computer link unit are connected via RS-232C, set the buffer memory in the computer link unit using the sequence program so that CD signals are not checked. Refer to the program example below in which the I/O signals of the computer link unit are 80 to 9F (H). Examples of the CPU units equipped with built-in computer link are explained below also.

#### In the case of A computer link

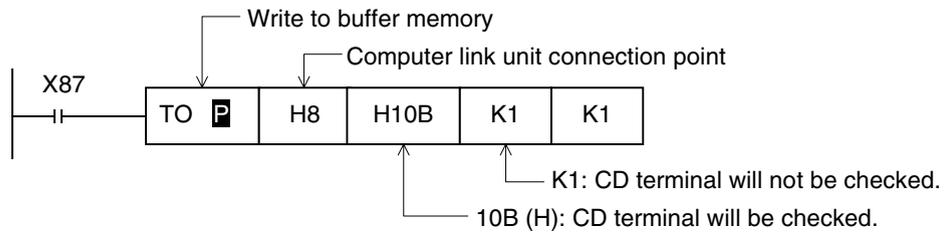

#### In the case of CPU equipped with built-in computer link

- A1SCPUC24-R2

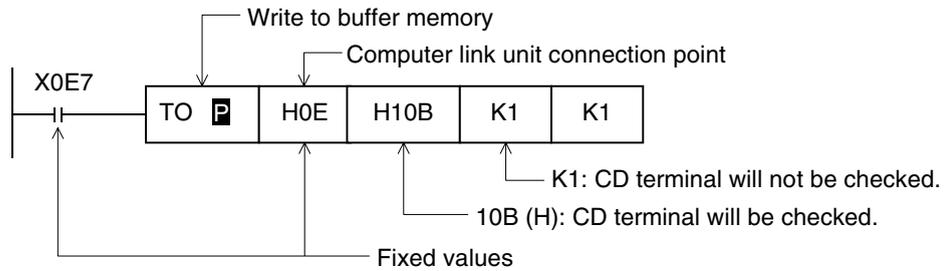

- A2CCPUC24

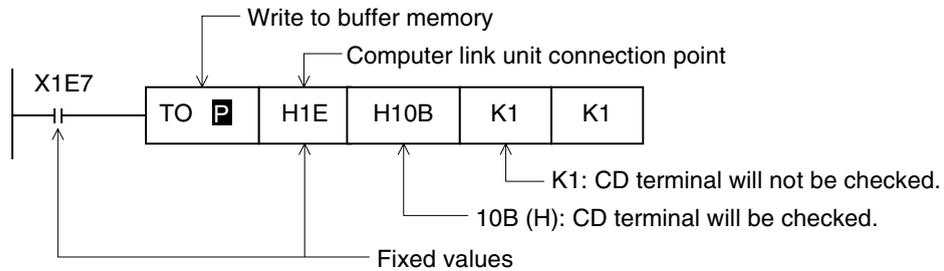

9.3.3 Setting Examples

1) RS-422 connection

a) When the AJ71UC24 is connected

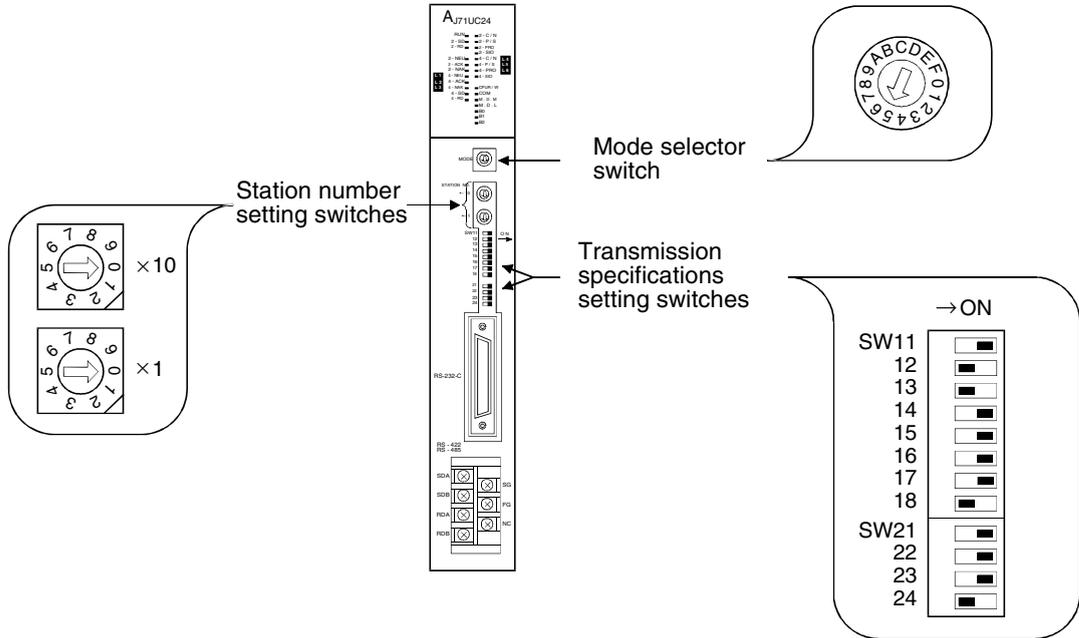

b) When the A1S71UC24-R4/A1S71C24-R4 is connected

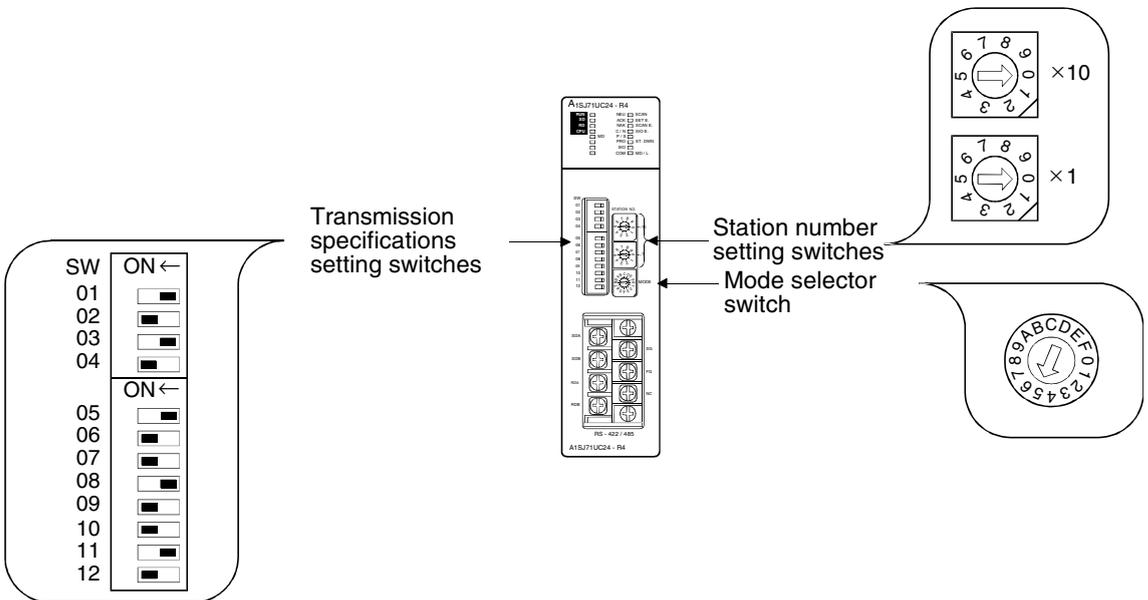

2) RS-232C connection

a) When the AJ71UC24 is connected

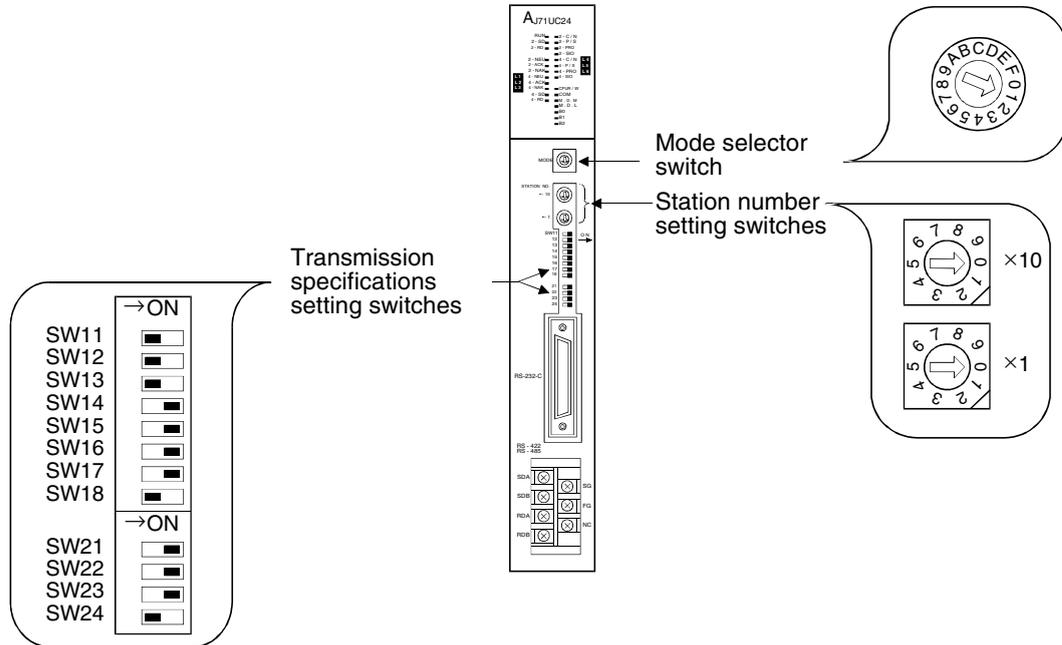

b) When the A1SJ71UC24-R2/A1SJ71C24-R2 is connected

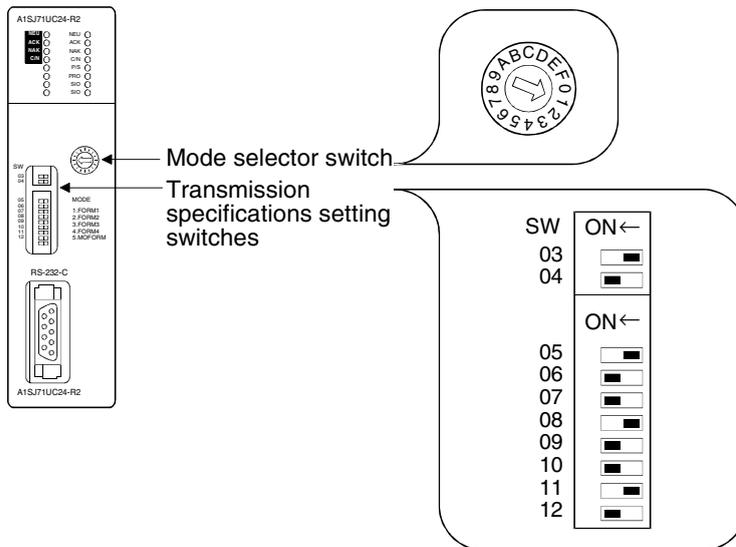



c) When the A1SCPU24-R2 is connected

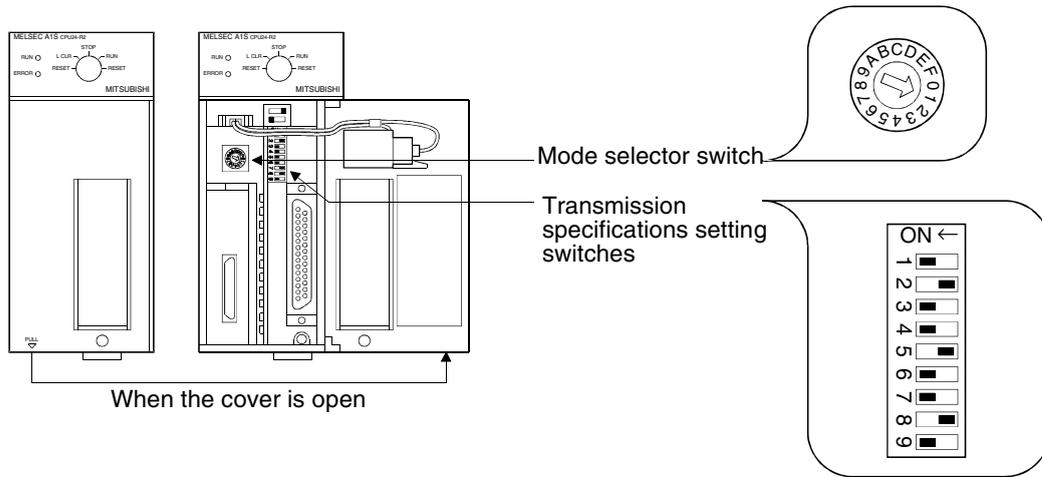

d) When the A2CCPUC24 is connected

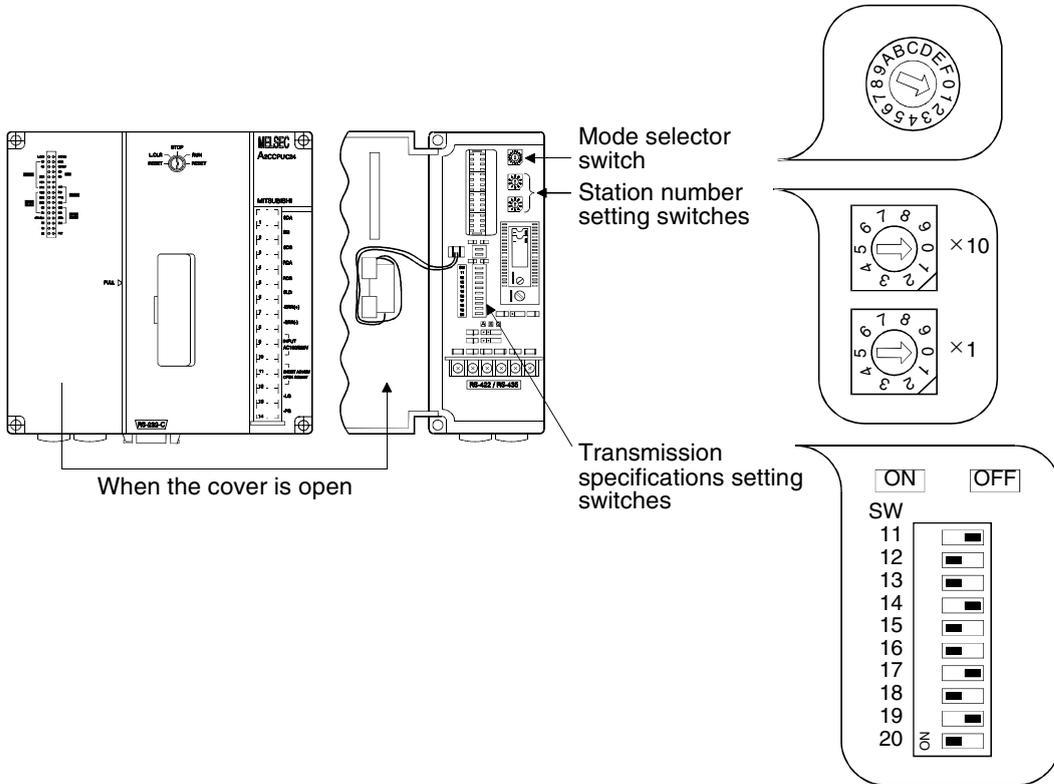

1	Introduction
2	Outline
3	Specifications
4	Installation and Wiring of F940GOT
5	Installation and Wiring of Handy GOT
6	Connection of Peripheral Equipment
7	Connection of Two or More GOT Units
8	Connection of MELSEC-F Series PLC
9	Connection of MELSEC-A Series PLC
10	Connection of MELSEC-QnA Series PLC

### 9.3.4 Used Connectors and Connector Covers

#### 1) Connectors on the GOT side

- For the shape of the connector of the cable on the GOT side (excluding the Handy GOT), refer to chapter 4.
- For the shape of the connector of the cable dedicated to the Handy GOT, refer to chapter 5.

#### 2) Connector on the computer link unit side

The computer link unit described in this manual is equipped with the RS-232C port having the following number of pins.

The RS-422 port is provided in a terminal block form.

Computer link unit model name	RS-232C connector shape	Model name	Included with
AJ71UC24	25-pin, female	17L-10250-27-D9AC(manufactured by DDK) Screw-tightening type	-
A1SJ71UC24-R2,A1SJ71C24-R2	9-pin, female	17L-10090-27-D9AC (manufactured by DDK) Screw-tightening type	✓
A1SCPUC24-R2	9-pin, female		✓
A2CCPUC24	9-pin, female		✓

A connector to be used for the port in the computer link unit may be included in a package.

### 9.3.5 Cable Specifications and Length

#### 1) Cable for RS-422 (excluding the Handy GOT)

Any cable satisfying the following specifications can be used.

Item	Description
Cable type	Shielded cable
Number of pairs	3P
Conductor resistance (at 20°C)	88.0Ω/km or less
Insulation resistance	10000MΩ/km or more
Withstand voltage	500V DC for 1 min
Electrostatic capacity (at 1kHz)	Average: 60nF/km or less
Characteristics impedance (at 100kHz)	110±10Ω

Recommended cable

SPEV(SB)-MPC-0.2 × 3P	MITSUBISHI CABLE INDUSTRIES, LTD
SPEV(SB)-0.2 × 3P	

\* The recommended cables SPEV(SB)-MPC-0.2 × 3P and SPEV(SB)-0.2 × 3P are equivalent in the electrical characteristics, but partially different in the outside dimension and the internal wire color.

#### 2) Cable for RS-232C (excluding the Handy GOT)

Use a cable less than 15m (49' 3")

Recommended cable

7/0.127□P HRV-SV □: Specifies the number of pairs. Example: In the case of 13 pairs, "7/0.127 13P HRV-SV"	RS-232C cable manufactured by Oki Electric Cable Company, Limited.
---	--

## 9.4 Caution on Use of MELSEC-A Series PLC

When using the GOT-F900 connected to the A Series PLC, observe the following caution on use.

### 9.4.1 Caution when the GOT-F900 is connected to the computer link unit

When the GOT is connected, the CH1 and the CH2 of the computer link unit cannot be used at the same time.

Accordingly, only one GOT unit can be connected to the computer link unit.

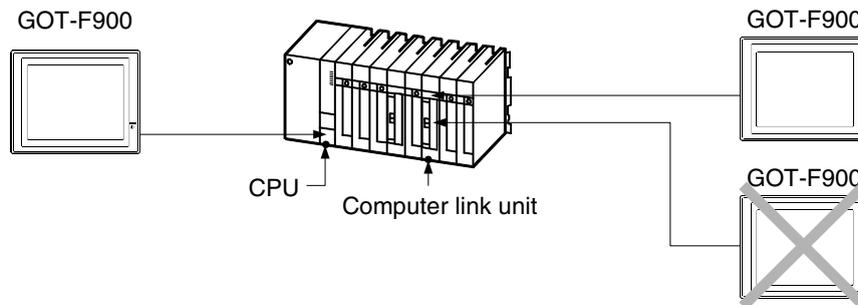

However, a GOT unit or a personal computer can be connected to the RS-422 port of the ACPU while the computer link unit has one GOT unit.

### 9.4.2 Caution when displaying the Ascii code

When a GOT-F900 is connected to the computer link unit, Ascii data created using GT Designer(2) or DU/WIN is displayed in reverse order as shown below (lower character on the left, upper character on the right).

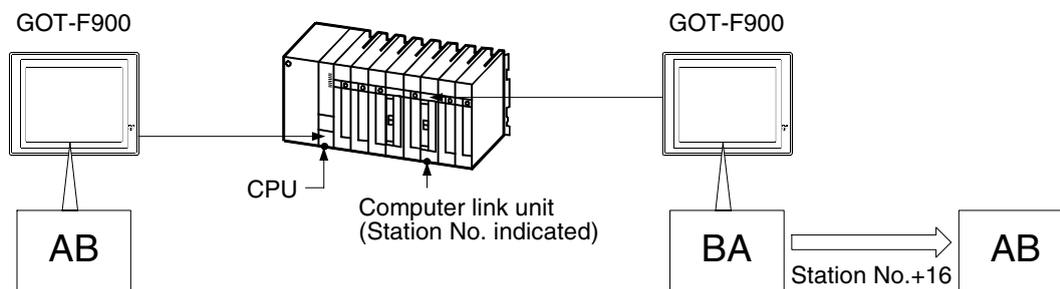

When connecting two or more GOTs, set the station number on the GOT connected to the computer link unit so that the characters displayed on all the GOT units look the same:

**Station number of computer link unit + 16 = Set Value on GOT-F900 (DST STATION #)**

## 9.5 Setting of Connected Equipment for GOT

The setting for connection to the A Series PLC can be executed using the GOT-F900 and the screen creation software (GT Designer2, GT Designer or DU/WIN).

### 1) GOT-F900 Series

When the main menu screen change operation is disabled.

Operation	Display (screen name)
a) While pressing and holding the upper left corner of the screen, turn on the power. Keep holding the upper left corner for about 25 seconds more. Then, press "END" at the upper right corner.	The "LANGUAGE" screen appears.
b) Press "PLC TYPE".	The "SET-UP MODE" screen appears.
c) Set the following. PLC TYPE: A SERIES CONNECTION: CPU PORT (RS-422) LINK PORT (RS-422) LINK PORT (RS-232C) DST STATION # (STATION #) : 00 to 15 GOT STATION # (-) : -	The "PLC TYPE" screen appears.

When the main menu screen change operation is enabled.

Operation	Display (screen name)
a) Press the upper left corner of the screen. (The position to be pressed can be changed in the GOT and the screen creation software.)	The "SELECT MODE" screen appears.
b) Press "OTHER MODE" on the menu.	The "OTHER MODE" screen appears.
c) Press "SET-UP MODE" on the menu.	The "SET-UP MODE" screen appears.
d) Press "PLC TYPE".	The "PLC TYPE" screen appears.
e) Set the following. PLC TYPE: A SERIES CONNECTION: CPU PORT (RS-422) LINK PORT (RS-422) LINK PORT (RS-232C) DST STATION # (STATION #) : 00 to 15 GOT STATION # (-) : -	

- When the screen data is transferred to the GOT-F900, the old data including the PLC type, connection type, and station number are overwritten.
- The "PLC type" selection item display varies depending on the OS version as follows.

GOT-F900		"PLC TYPE" selection item display in GOT			
		A SERIES	A, QnA SERIES	A SERIES *1 QnA, Q SERIES	A SERIES QnA, Q SERIES Q (Multi) SERIES
OS version	F940WGOT	-	-	1.00 or later	1.30 or later
	F940GOT, Handy GOT	1.00 or later	3.00 or later	4.10 or later	6.30 or later
	F930GOT-K	-	-	4.60 or later	4.60 or later
	F930GOT	1.00 or later	2.00 or later	2.20 or later	4.30 or later
	F920GOT-K	-	-	1.00 or later	1.00 or later
Connection setting availability		Available	Available	Available (Select "A SERIES".)	Available (Select "A SERIES".)

\*1 Note that the selection item display is changed from "A, QnA SERIES" to "A SERIES" and "QnA, Q SERIES".

2) GT Designer2

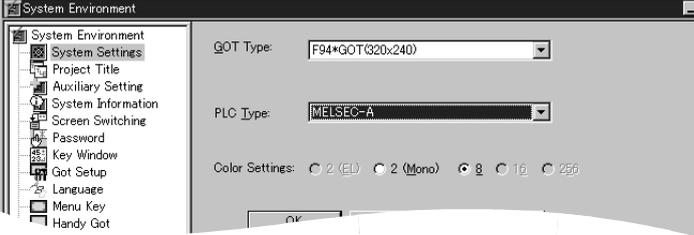
	Operation	Display (screen name)										
[Creation]	<p>a) Open GT Designer2.</p> <p>b) Click the [NEW] button. The dialog box shown below is displayed. If it is not displayed, click "System Environment" in the tree displayed in the project work space, then click "System settings" in the tree.</p>  <p>c) Set the following.</p> <p>GOT type: F940WGOT (480 × 234)                    F94*GOT (320 × 240)                    F93*GOT (240 × 80)                    F920GOT (128 × 64)</p> <p>PLC type: MELSEC-A</p> <p>Selection of "GOT type"</p> <table border="1" data-bbox="485 1014 1114 1272"> <thead> <tr> <th>GOT type</th> <th>Model name (name)</th> </tr> </thead> <tbody> <tr> <td>F940WGOT(480×234)&lt;WIDE&gt;</td> <td>F940WGOT</td> </tr> <tr> <td>F94*GOT(320×240)</td> <td>F940GOT Handy GOT</td> </tr> <tr> <td>F93*GOT(240×80)</td> <td>F930GOT F930GOT-K</td> </tr> <tr> <td>F920GOT(128×64)</td> <td>F920GOT-K</td> </tr> </tbody> </table> <p>Click [OK].</p>	GOT type	Model name (name)	F940WGOT(480×234)<WIDE>	F940WGOT	F94*GOT(320×240)	F940GOT Handy GOT	F93*GOT(240×80)	F930GOT F930GOT-K	F920GOT(128×64)	F920GOT-K	<p>The "Select Project" dialog box appears.</p> <p>The "System Environment" dialog box appears.</p>
GOT type	Model name (name)											
F940WGOT(480×234)<WIDE>	F940WGOT											
F94*GOT(320×240)	F940GOT Handy GOT											
F93*GOT(240×80)	F930GOT F930GOT-K											
F920GOT(128×64)	F920GOT-K											

1	Introduction
2	Outline
3	Specifications
4	Installation and Wiring of F940GOT
5	Installation and Wiring of Handy GOT
6	Connection of Peripheral Equipment
7	Connection of Two or More GOT Units
8	Connection of MELSEC-F FX Series PLC
9	Connection of MELSEC-A Series PLC
10	Connection of MELSEC-QnA Series PLC

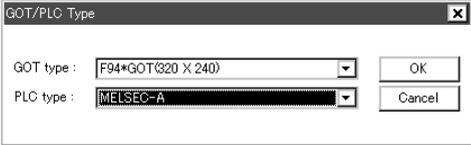
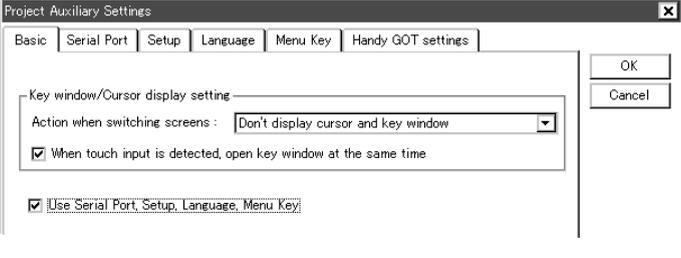
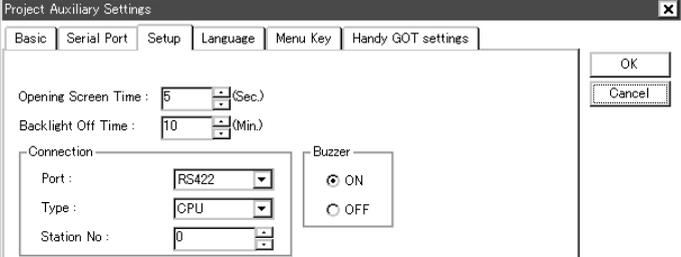

3) GT Designer

	Operation	Display (screen name)										
[Creation]	<p>a) Open the GT Designer.</p> <p>b) Click the [New] button.</p>  <p>c) Set the following.</p> <p>GOT type: F940WGOT (480 × 234) &lt;WIDE&gt;            F94*GOT (320 × 240)            F93*GOT (240 × 80)            F920GOT(128 × 64)</p> <p>PLC type: MELSEC-A</p> <p>Selection of "GOT type"</p> <table border="1" data-bbox="497 808 1106 1066"> <thead> <tr> <th>GOT type</th> <th>Model name</th> </tr> </thead> <tbody> <tr> <td>F940WGOT(480×234)&lt;WIDE&gt;</td> <td>F940WGOT</td> </tr> <tr> <td>F94*GOT(320×240)</td> <td>F940GOT Handy GOT</td> </tr> <tr> <td>F93*GOT(240×80)</td> <td>F930GOT-K F930GOT</td> </tr> <tr> <td>F920GOT(128×64)</td> <td>F920GOT-K</td> </tr> </tbody> </table> <p>Click [OK].</p> <p>d) Set CPU direct connection (RS-422)/link connection (RS-422/RS-232C) of the GOT-F900.            This setting is enabled in the SW4D5C-GOTR-PACKE version A or later.            Click the check box of "Use Serial Port, Setup, Language, Menu Key" to give a check mark (✓).</p>  <p>Click the "Setup" tab.</p> 	GOT type	Model name	F940WGOT(480×234)<WIDE>	F940WGOT	F94*GOT(320×240)	F940GOT Handy GOT	F93*GOT(240×80)	F930GOT-K F930GOT	F920GOT(128×64)	F920GOT-K	<p>The "Select Project" dialog box appears.</p> <p>The "GOT/PLC Type" dialog box appears.</p> <p>The "Project Auxiliary Settings" dialog box appears..</p>
GOT type	Model name											
F940WGOT(480×234)<WIDE>	F940WGOT											
F94*GOT(320×240)	F940GOT Handy GOT											
F93*GOT(240×80)	F930GOT-K F930GOT											
F920GOT(128×64)	F920GOT-K											

1	Introduction
2	Outline
3	Specifications
4	Installation and Wiring of F940GOT
5	Installation and Wiring of Handy GOT
6	Connection of Peripheral Equipment
7	Connection of Two or More GOT Units
8	Connection of MELSEC-F FX Series PLC
9	Connection of MELSEC-A Series PLC
10	Connection of MELSEC-QnA Series PLC

Operation		Display (screen name)							
	<p>In the case of SW4D5C-GOTR-PACKE earlier than version A, perform the setting in the GOT-F900. (Set the connection in "CONNECTION" in the GOT-F900.) For the setting method, refer to "1) GOT-F900 Series" on the previous page.</p> <p>e)Set the following. Port : RS-422 RS-232C Type : CPU LINK DST Station No. (Station No.) : 00 to 15 GOT Station No. (-) : -</p> <p><u>In the case of F943 Handy GOT</u> Without regard to the port setting (RS-422 or RS-232C), the COM0 side of the RS-232C is fixed for PLC connection. Combinations of "Port" and "Type" are as follows.</p> <table border="1"> <thead> <tr> <th>Port</th> <th>Type</th> </tr> </thead> <tbody> <tr> <td rowspan="2">RS-422</td> <td>CPU</td> </tr> <tr> <td>LINK</td> </tr> <tr> <td>RS-232C</td> <td>LINK</td> </tr> </tbody> </table>	Port	Type	RS-422	CPU	LINK	RS-232C	LINK	
Port	Type								
RS-422	CPU								
	LINK								
RS-232C	LINK								
[Change method]	<p>Change the connection type of the already created data as follows.</p> <p>a)Open GT Designer. b)Click the [Open] button. c)Open (read) the screen data to be changed. d)On the menu, select "Common"-&gt;"GOT/PLC Type". - For the contents of setting, refer to c) of [Creation] above. - For selection of the RS-232C (CPU/LINK) or the RS-422 (CPU/LINK) on the A Series PLCs, refer to e) of [Creation] above.</p>	<p>The "Select project" dialog box appears.</p> <p>The "GOT/PLC Type" dialog box appears.</p>							

- The "PLC type" selection item display varies depending on the software version as follows.

GT Designer	"PLC type" selection item display in GT Designer			
	MELSEC-A	MELSEC-A, QnA	MELSEC-A *1 MELSEC-QnA, Q	MELSEC-A MELSEC-QnA, Q MELSEC-Q(Multi)
Version	SW1-A or later	SW2-A or later	SW4-F	SW5-P (5.13P)
Connection setting availability	Available	Available	Available (Select "MELSEC-A".)	Available (Select "MELSEC-A".)

\*1 Note that the selection item display is changed from "MELSEC-A, QnA" to "MELSEC-A" and "MELSEC-QnA, Q".





Operation		Display (screen name)							
	<p>e)Set the following.                      Port: RS-422                      RS-232C                      Type: CPU                      LINK                      DST Station No. (Station No.) : 00 to 15                      GOT Station No. (-) : -                      In the case of F943 Handy GOT                      Without regard to the port setting (RS-422 or RS-232C), the COM0 side of the RS-232C is fixed for PLC connection.                      Combinations of "Port" and "Type" are as follows.</p> <table border="1"> <thead> <tr> <th>Port</th> <th>Type</th> </tr> </thead> <tbody> <tr> <td rowspan="2">RS-422</td> <td>CPU</td> </tr> <tr> <td>LINK</td> </tr> <tr> <td>RS-232C</td> <td>LINK</td> </tr> </tbody> </table>	Port	Type	RS-422	CPU	LINK	RS-232C	LINK	The "Setup Data" dialog box appears.
Port	Type								
RS-422	CPU								
	LINK								
RS-232C	LINK								
[Change method]	<p>Change the connection type of the already created data as follows.                      a)Open DU/WIN.                      b)On the menu, select "File"-"Open".                      c)Select and open (read) the file of the screen data to be changed.                      d)When changing "Terminal" (GOT-F900), select "View/Project"-"System Settings"-"Project settings" on the menu.                      For the contents of setting, refer to c) in [Creation] above.                      - For the contents of setting, refer to c) of [Creation] above.                      - For selection of the RS-232C (CPU/LINK) or the RS-422 (CPU/LINK) on the A Series PLCs, refer to e) of [Creation] above.</p>	<p>The "Open" dialog box appears.                      The "Project settings" dialog box appears.</p>							

- The "PLC" selection item display varies depending on the OS version as follows.

DU/WIN	"PLC System" selection item display in DU/WIN		
	MELSEC-A	MELSEC-A, QnA	MELSEC-A *1 MELSEC-QnA, Q
Version	2.00 or later	2.30 or later	2.40 or later
Connection setting availability	Available	Available	Available (Select "MELSEC-A".)

\*1 Note that the selection item display is changed from "MELSEC-A, QnA" to "MELSEC-A" and "MELSEC-QnA, Q".

## 9.6 Cable Diagram

This section explains cable diagrams to connect the GOT-F900 and the A Series PLC.

### 9.6.1 Cautions on preparing cables

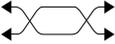
- 1) When preparing the cables, use the wire size of 0.08mm<sup>2</sup> or more (AWG28 or more) for communication, 0.3mm<sup>2</sup> or more (AWG22 or more) for the power supply, operation switch, and emergency stop switch.
- 2)  stands for a twisted pair cable. Prepare a twisted pair cable in combination of the pin numbers and signal lines described on the cable diagram.  
Do not use a twisted pair cable with the power supply wire and the communication wire.

### 9.6.2 Cable diagram

#### 1) Cable for the GOT and the A Series PLC

F920GOT-K (5V type)

 : Female type  : Male type The connector figure shows the engagement face.

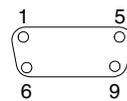
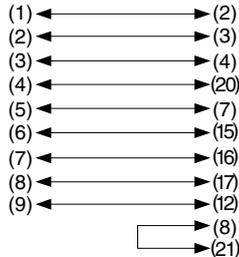
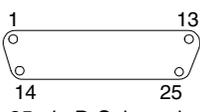
No.	Model name	Application	Connection diagram	Application
a)	<p>RS-422 connection</p> <p><u>A CPU direct connection</u> Prepared by the user (Cable length 3m (9'10") or less)</p> <p>Resistance per wire: 0.67 Ω or less (Approximately AWG 28 or thicker)</p>	<p>To GOT-F900</p>  <p>9-pin D-Sub, male</p>		<p>To A Series</p>  <p>25-pin D-Sub, male</p>

1	Introduction
2	Outline
3	Specifications
4	Installation of F940GOT
5	Installation and Wiring of Handy GOT
6	Connection of Peripheral Equipment
7	Connection of Two or More GOT Units
8	Connection of MELSEC-F FX Series PLC
9	Connection of MELSEC-A Series PLC
10	Connection of MELSEC-QnA Series PLC

F920GOT-K (24V type)/F930GOT/F930GOT-K/F940GOT/F940WGOT

 : Female type  : Male type The connector figure shows the engagement face.

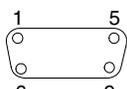
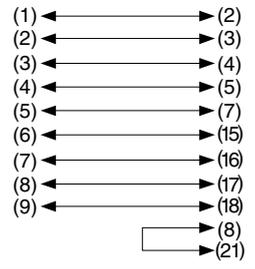
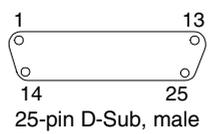
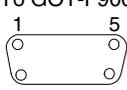
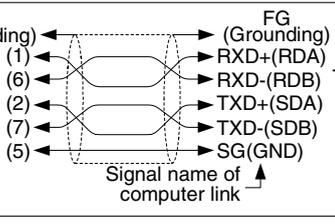
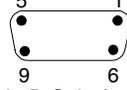
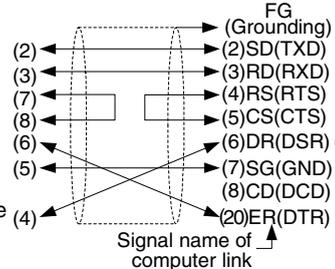
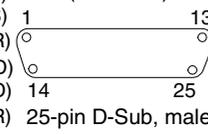
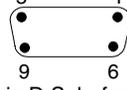
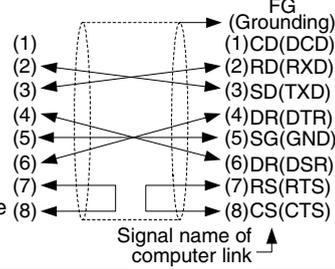
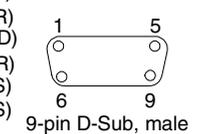
No.	Model name	Application	Connection diagram	Application
a)	<p><b>RS-422 connection</b></p> <p><b>A CPU direct connection</b>                      FX-40DU-CAB                      FX-40DU-CAB-10M                      FX-40DU-CAB-20M                      FX-40DU-CAB-30M                      FX-50DU-CABL</p>	<p>To GOT-F900</p>  <p>9-pin D-Sub, male</p>		<p>To A Series</p>  <p>25-pin D-Sub, male</p>
b)	<p><b>RS-422 connection</b></p> <p><b>A computer link Prepared by the user</b>                      Connect the terminating resistors on the computer link unit side. For details, refer to the User's manual of the computer link unit.</p>	<p>To GOT-F900</p>  <p>9-pin D-Sub, male</p>	 <p>Signal name of computer link</p>	<p>Terminal block To computer link unit side (PLC side)</p>
c)	<p><b>RS-232C connection</b></p> <p><b>A computer link F2-232CAB-1</b>                      (The connection diagram is partially different.)</p>	<p>To GOT-F900</p>  <p>9-pin D-Sub, female</p>	 <p>Signal name of computer link</p>	<p>To computer link unit side (PLC side)</p>  <p>25-pin D-Sub, male</p>
d)	<p><b>RS-232C connection</b></p> <p>Prepared by the user</p>	<p>To GOT-F900</p>  <p>9-pin D-Sub, female</p>	 <p>Signal name of computer link</p>	<p>To computer link unit side (PLC side)</p>  <p>9-pin D-Sub, male</p>

2) Cable for the Handy GOT and the A Series PLC

When using the Handy GOT RH model, refer to the cable diagrams below for the RS-422/RS-232C connector, but not the wiring for the power supply, the operation switches, and the emergency stop switch because it is different. For details, refer to Section 5.18.

 : Female type  : Male type The connector figure shows the engagement face.

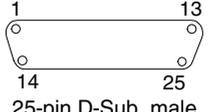
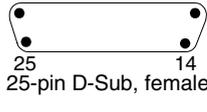
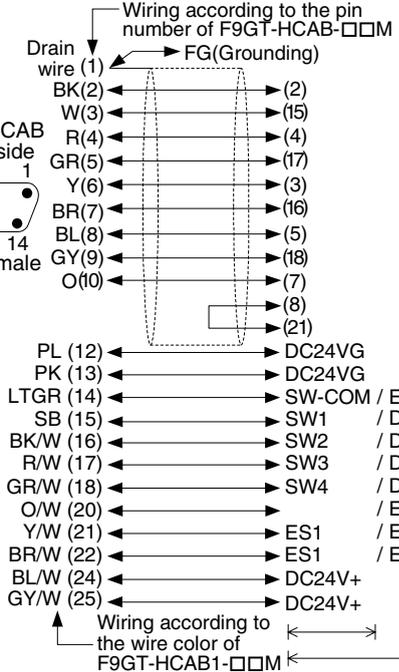
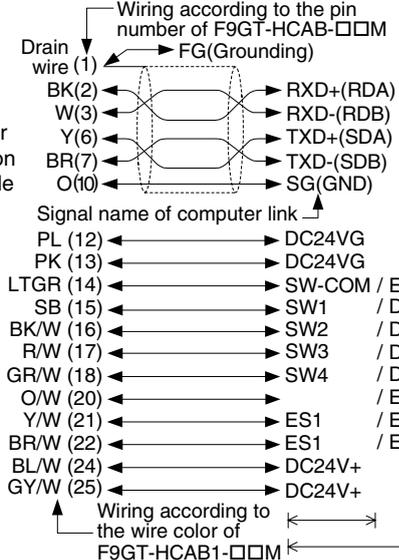
No.	Model name	Application	Connection diagram	Application
a)	F9GT-HCAB-3M F9GT-HCAB-10M	<div style="border: 1px solid black; padding: 2px; display: inline-block;">RS-422 connection</div> <div style="border: 1px solid black; padding: 2px; display: inline-block;">RS-232C connection</div> Dedicated connector on Handy GOT side	The connector on the leader side of the Handy GOT is dedicated, and cannot be prepared by the user.	To F9GT-HCAB3-150  25-pin D-Sub, male
b)	F9GT-HCAB1-3M F9GT-HCAB1-10M	<div style="border: 1px solid black; padding: 2px; display: inline-block;">RS-422 connection</div> <div style="border: 1px solid black; padding: 2px; display: inline-block;">RS-232C connection</div> Dedicated connector on Handy GOT side	The connector on the leader side of the Handy GOT is dedicated, and cannot be prepared by the user.	Loose wires (no connector)
c)	F9GT-HCAB3-150	<div style="border: 1px solid black; padding: 2px; display: inline-block;">RS-422 connection</div> To cable F9GT-HCAB on Handy GOT side  25-pin D-Sub, female	Wiring according to the pin number of F9GT-HCAB-□□□M  Drain wire (1) → FG(Grounding) BK(2) → (2) W(3) → (15) R(4) → (4) GR(5) → (17) Y(6) → (3) BR(7) → (16) BL(8) → (5) GY(9) → (18) O(10) → (7) (8) → (8) (21) → (21) PL(12) → DC24VG PK(13) → DC24VG LTGR(14) → SW-COM / ES1-2 SB(15) → SW1 / DSW2 BK/W(16) → SW2 / DSW2 R/W(17) → SW3 / DSW1 GR/W(18) → SW4 / DSW1 O/W(20) → / ES1-2 Y/W(21) → ES1 / ES1-1 BR/W(22) → ES1 / ES1-1 BL/W(24) → DC24V+ GY/W(25) → DC24V+ Old cable description ← Wiring according to the wire color of F9GT-HCAB1-□□□M → New cable description	To A Series  25-pin D-Sub, male Wire the power supply, the operation switches and the emergency stop switch.
d)	<u>A computer link</u> Prepared by the user	To cable F9GT-HCAB or F9GT-HCAB1 on Handy GOT side	Wiring according to the pin number of F9GT-HCAB-□□□M  Drain wire (1) → FG(Grounding) BK(2) → RXD+(RDA) W(3) → RXD-(RDB) Y(6) → TXD+(SDA) BR(7) → TXD-(SDB) O(10) → SG(GND) Signal name of computer link PL(12) → DC24VG PK(13) → DC24VG LTGR(14) → SW-COM / ES1-2 SB(15) → SW1 / DSW2 BK/W(16) → SW2 / DSW2 R/W(17) → SW3 / DSW1 GR/W(18) → SW4 / DSW1 O/W(20) → / ES1-2 Y/W(21) → ES1 / ES1-1 BR/W(22) → ES1 / ES1-1 BL/W(24) → DC24V+ GY/W(25) → DC24V+ Old cable description ← Wiring according to the wire color of F9GT-HCAB1-□□□M → New cable description	Terminal block To computer link unit side (PLC side) Wire the power supply, the operation switches and the emergency stop switch.

1	Introduction
2	Outline
3	Specifications
4	Installation and Wiring of F940GOT
5	Installation and Wiring of Handy GOT
6	Connection of Peripheral Equipment
7	Connection of Two or More GOT Units
8	Connection of MELSEC-F FX Series PLC
9	Connection of MELSEC-A Series PLC
10	Connection of MELSEC-QnA Series PLC

: Female type : Male type The connector figure shows the engagement face.

No.	Model name	Application	Connection diagram	Application
e)	<p><b>RS-232C connection</b></p> <p><b>A computer link</b> Prepared by the user</p>	<p>To cable F9GT-HCAB or F9GT-HCAB1 on Handy GOT side</p>	<p>Wiring according to the pin number of F9GT-HCAB-□□□M</p> <p>Wiring according to the wire color of F9GT-HCAB1-□□□M</p>	<p>To computer link unit side (PLC side)</p> <p>25-pin D-Sub, male</p> <p>Wire the power supply, the operation switches and the emergency stop switch.</p> <p>Old cable description  New cable description </p>
f)	<p><b>RS-232C connection</b></p> <p>Prepared by the user</p>	<p>To cable F9GT-HCAB or F9GT-HCAB1 on Handy GOT side</p>	<p>Wiring according to the pin number of F9GT-HCAB-□□□M</p> <p>Wiring according to the wire color of F9GT-HCAB1-□□□M</p>	<p>To computer link unit side (PLC side)</p> <p>9-pin D-Sub, male</p> <p>Wire the power supply, the operation switches and the emergency stop switch.</p> <p>Old cable description  New cable description </p>
g)	<p><b>RS-422 connection</b></p> <p><b>ACPU direct connection</b> FX-40DU-CAB</p>	<p>To F9GT-HCNB</p> <p>9-pin D-Sub, male</p>		<p>To A Series</p> <p>25-pin D-Sub, male</p>
h)	<p><b>RS-422 connection</b></p> <p><b>A computer link</b> Prepared by the user</p> <p>Connect the terminating resistors on the computer link unit side. For details, refer to the User's manual of the computer link unit.</p>	<p>To F9GT-HCNB</p> <p>9-pin D-Sub, male</p>	<p>Wiring according to the pin number of F9GT-HCNB-□□□M</p> <p>Signal name of computer link</p>	<p>Terminal block</p> <p>To computer link unit side (PLC side)</p>

## 9.7 Troubleshooting

For reference, this section summarizes frequently asked questions about connection of the GOT-F900 to the A Series PLC.

The slightly different messages may be displayed on the F920GOT-K.

### 1) GOT-F900

Contents of trouble	Check points and countermeasures	OS version			
		F940W	F940	F930	F920
<p>"COMMUNICATION ERROR OCCURS" is displayed when a screen changeover or numeric data input is performed on the GOT-F900 screen by a touch key *1.</p> <p>*1 No touch key is available on the F920GOT-K.</p>	<p>The power of the A Series PLC is turned off.</p> <ul style="list-style-type: none"> <li>• Cause Communication is disabled because the power of the A Series PLC is turned off.</li> <li>• Countermeasures Turn on the power.</li> </ul> <p>Something is wrong with the cable between the GOT-F900 and the A Series PLC.</p> <ul style="list-style-type: none"> <li>• Causes The wrong cable is used or the connection is bad.</li> <li>• Countermeasures Check the cable.</li> </ul>	From first product	From first product	From first product	From first product
<p>"DISPLAY SCREEN IS NOT AVAILABLE." is displayed on the GOT-F900 screen.</p>	<p>Changeover to a nonexistent screen by a touch key or the A Series PLC was tried.</p> <ul style="list-style-type: none"> <li>• Cause The changeover destination screen has not been created yet.</li> <li>• Countermeasures Create the screen.</li> </ul>	-	Earlier than 6.00	Earlier than 4.00	-
<p>"DISPLAY SCREEN IS NOT AVAILABLE. (NO. #####)" is displayed on the GOT-F900 screen.</p>	<p>A nonexistent screen was tried to be displayed.</p> <ul style="list-style-type: none"> <li>• Cause The screen No. ##### has not been created yet.</li> <li>• Countermeasures Create the screen.</li> </ul>	From first product	6.00 or later	4.00 or later	From first product

1	Introduction
2	Outline
3	Specifications
4	Installation and Wiring of F940GOT
5	Installation and Wiring of Handy GOT
6	Connection of Peripheral Equipment
7	Connection of Two or More GOT Units
8	Connection of MELSEC-F FX Series PLC
9	Connection of MELSEC-A Series PLC
10	Connection of MELSEC-QnA Series PLC

Contents of trouble	Check points and countermeasures	OS version			
		F940W	F940	F930	F920
"DISPLAY SCREEN IS NOT AVAILABLE." is displayed on the GOT-F900 screen.	<p>A device that does not exist in the A Series PLC was referenced. (Example: While an A1S Series PLC is connected, a device exists only in the AnU Series PLC is specified for numeric input.)</p> <ul style="list-style-type: none"> <li>• Cause On the changeover destination screen (excluding the head screen), a nonexistent device in the connected A Series PLC is specified.</li> <li>• Countermeasures Check the devices used on the head screen.</li> </ul>	-	Earlier than 6.00	Earlier than 4.00	-
	<p>When a PLC is not connected, the GOT defaults to the A mode.</p> <ul style="list-style-type: none"> <li>• Cause Check for the A or AnU Series was executed, the connection mode was automatically changed over, then the device range was checked. This error occurs when the device range set on the changeover destination screen (excluding the head screen) is beyond the range for the A Series.</li> <li>• Countermeasures Connect the PLC.</li> </ul>				
	<p>There is an error on the screen to be displayed.</p> <ul style="list-style-type: none"> <li>• Cause One of the screen objects is placed outside the available screen area.</li> <li>• Countermeasures Check the placement of screen objects.</li> </ul>				
"DISPLAY SCREEN IS NOT AVAILABLE. (NO. #####)" is displayed on the GOT-F900 screen.	<p>The display screen contains an error.</p> <ul style="list-style-type: none"> <li>• Causes A device that does not exist in the connected PLC is referenced on the screen No. #####, or one of the screen objects is placed outside the available screen area.</li> <li>• Countermeasures Check the devices used and placement of screen objects.</li> </ul>	From first product	6.00 or later	4.00 or later	From first product



Contents of trouble	Check points and countermeasures	OS version			
		F940W	F940	F930	F920
"DATA IS NOT FOUND." is displayed on the GOT-F900 screen.	<p>There is not data because the unit is new or the memory clear has been executed.</p> <ul style="list-style-type: none"> <li>• Cause There is no screen data.</li> <li>• Countermeasures Write the screen data using the screen creation software.</li> </ul>				
	<p>A device that does not exist in the A Series PLC was referenced. (Example: While the A1S Series PLC was connected, a device provided only in the AnU Series PLC was specified for numeric input.)</p> <ul style="list-style-type: none"> <li>• Cause On the head screen, a nonexistent device in the connected A Series PLC is specified. (The head screen is the screen No. 1 in the GT Designer, and the screen No. 0 in the DU/WIN.)</li> <li>• Countermeasures Check the devices used on the head screen.</li> </ul>	-	Earlier than 6.00	Earlier than 4.00	-
	<p>While the A Series PLC is not connected, the connection mode for the A Series PLC is selected.</p> <ul style="list-style-type: none"> <li>• Cause Check for the A or AnU Series was executed, the connection mode was automatically changed over, then the device range was checked. This error occurs when the device range set on the head screen is beyond the range for the A Series. (The head screen is the screen No. 1 in the GT Designer, and the screen No. 0 in the DU/WIN.)</li> <li>• Countermeasures Connect the PLC.</li> </ul>				
	<p>There is not data because the unit is new or the memory clear has been executed.</p> <ul style="list-style-type: none"> <li>• Cause There is no screen data.</li> <li>• Countermeasures Write the screen data using the screen creation software.</li> </ul>	From first product	6.00 or later	4.00 or later	From first product
"CAN NOT WRITE TO PLC MEMORY." is displayed on the GOT-F900 screen.	This error is not displayed.	Earlier than 1.10	Earlier than 6.10	Earlier than 4.10	-
"CAN NOT WRITE." is displayed on the GOT-F900 screen.	This error is not displayed.	1.10 or later	6.10 or later	4.10 or later	From first product

- 1 Introduction
- 2 Outline
- 3 Specifications
- 4 Installation and Wiring of F940GOT
- 5 Installation and Wiring of Handy GOT
- 6 Connection of Peripheral Equipment
- 7 Connection of Two or More GOT Units
- 8 Connection of MELSEC-F FX Series PLC
- 9 Connection of MELSEC-A Series PLC
- 10 Connection of MELSEC-QnA Series PLC

Contents of trouble	Check points and countermeasures	OS version			
		F940W	F940	F930	F920
"CAN NOT USE THE FUNCTION WHILE PROTECTED." is displayed on the GOT-F900 screen.	<p>Programs and device set values of the A Series PLC cannot be changed.</p> <ul style="list-style-type: none"> <li>• Causes PLC Password protection is on.</li> <li>• Countermeasures Enter the keywords by "SELECT MODE"- "OTHER MODE"- "ENTRY CODE".</li> </ul>	From first product	From first product	From first product	From first product
"PLC IS RUNNING." is displayed on the GOT-F900 screen.	This error is not displayed.	From first product	From first product	From first product	From first product

2) Software

	Contents of trouble	Check points and countermeasures
Software such as GX Developer and FX/WIN	In the personal computer connected to the GOT-F900, sequence programs cannot be monitored or transferred. Communication with the sequence software is disabled. An error message is displayed.	<p>A PLC, bar code reader or printer is connected.</p> <ul style="list-style-type: none"> <li>• Causes The RS-232C connector to which the personal computer is connected is set to be used for another piece of equipment.</li> <li>• Countermeasures For monitoring or transferring sequence programs, set a bar code reader to invalid and a printer to "DON'T USE". If the PLC is connected, select the GOT-F900 equipped with two built-in RS-232C channels.</li> </ul> <hr/> <p>Something is wrong with the cable between the GOT-F900 and the personal computer.</p> <ul style="list-style-type: none"> <li>• Causes The wrong cable is used or the connection is bad.</li> <li>• Countermeasures Check the cable.</li> </ul>
Screen creation software	In the personal computer connected to the GOT-F900, screen data cannot be transferred. Communication with the screen creation software is disabled. An error message is displayed.	<p>A computer link, bar code reader or printer is connected.</p> <ul style="list-style-type: none"> <li>• Causes The RS-232C connector to which the personal computer is connected is set to be used for another piece of equipment.</li> <li>• Countermeasures In the GOT-F900, select by hand "SELECT MODE"-"OTHER MODE"-"DATA TRANSFER". Or set to invalid and a printer to "DON'T USE".</li> </ul> <hr/> <p>A personal computer is connected, and the software for PLC (such as GPP/W and FX/WIN) and the screen creation software are used at the same time.</p> <ul style="list-style-type: none"> <li>• Cause Program transfer or monitoring is executed by the PLC software.</li> <li>• Countermeasures Terminate program transfer or monitoring by the PLC software. If the error status still continues, shut down the PLC. Otherwise, shut down the personal computer, start it up again, then start up only the screen creation software.</li> </ul> <hr/> <p>Something is wrong with the cable between the GOT-F900 and the personal computer.</p> <ul style="list-style-type: none"> <li>• Causes The connected cable is not proper. Or cable connection is not correct.</li> <li>• Countermeasures Check the cable.</li> </ul>

1	Introduction
2	Outline
3	Specifications
4	Installation and Wiring of F940GOT
5	Installation and Wiring of Handy GOT
6	Connection of Peripheral Equipment
7	Connection of Two or More GOT Units
8	Connection of MELSEC-F FX Series PLC
9	Connection of MELSEC-A Series PLC
10	Connection of MELSEC-QnA Series PLC

# MEMO

## 10. Connection of MELSEC-QnA Series PLC

This chapter explains connection of the GOT-F900 Series display unit to the QnA Series PLC.

### Connection Procedure

This section introduces the procedure to connect the GOT-F900 to the QnA Series PLC.

#### 1. Preparation

Item name	Description	Reference
System Condition	You can learn the connection availability as well as the version of the GOT-F900 OS and the screen creation software.	10.1
System Configuration	You can select the configuration between the GOT and the QnA Series PLC/computer link unit as well as proper cables.	10.2

#### 2. Setting

Item name	Description	Reference					
QnACPU Selection in Direct Connection	In the QnA computer link, the following setting is required. When QnA connection is selected, the GOT-F900 is automatically set to fixed values. No setting is required in the QnA Series PLC.	–					
Setting in QnA Computer Link Connection	You can learn the communication specifications and the setting.	10.3					
	<table border="1"> <tbody> <tr> <td>Setting of QnA computer link</td> <td>The contents of setting of computer link</td> <td>10.3.1</td> </tr> <tr> <td>Setting examples</td> <td>Switch setting in each computer link</td> <td>10.3.2</td> </tr> </tbody> </table>	Setting of QnA computer link	The contents of setting of computer link	10.3.1	Setting examples	Switch setting in each computer link	10.3.2
Setting of QnA computer link	The contents of setting of computer link	10.3.1					
Setting examples	Switch setting in each computer link	10.3.2					
Caution on Use of MELSEC-QnA Series PLC	You can learn the restrictions in connecting the GOT to the QnA Series PLC.	10.4					
Setting of Connected Equipment for GOT	Set the PLC type using the GOT or the screen creation software.	10.5					

#### 3. Others

Item name	Description	Reference
Cable Diagram	Cable diagrams for QnA Series PLC/GOT connection	10.6
Troubleshooting	Description of errors and how to fix them	10.7

## 10.1 System Condition

When connecting the QnA Series PLC, check the COM port designation, the OS version of the GOT-F900, and the applicable version of the screen creation software.

Compatibility when connecting QnA Series PLC

GOT-F900 Series	COM port		Connection type		OS version of GOT-F900	Version of screen creation software		
	RS-422	RS-232C	1:1	Two or more GOT units		GT Designer2	GT Designer	DU/WIN
F920GOT-K(5V)	△	–	✓	–	1.00	SW1-C	SW5-26C	2.70
F920GOT-K(24V)	✓	✓	✓	–	1.20	SW1-C	–	–
F930GOT	✓	✓	✓	✓	2.00	SW1-C	SW2-A	2.30
F930GOT-K	✓	✓	✓	✓	4.60	SW1-C	SW5-26C	2.70
F940GOT	✓	✓	✓	✓	3.00	SW1-C	SW2-A	2.30
F940WGOT	✓	✓	✓	✓	1.00	SW1-C	SW5-F	2.50
F940 Handy GOT	✓	–	✓	–*1	3.00	SW1-C	SW2-A	2.30
F943 Handy GOT	–	✓	✓	–*1	3.00	SW1-C	SW2-A	2.30

- "△" in this table indicates that only connection via the programming connector of the QnA CPU is available, and computer link connection and connection to a serial communication unit are not available.
- Connection of two or more GOT units is possible only in QnACPU direct connection and QnA computer link connection. It is not possible in A computer link connection.
- The screen creation software version corresponds to the model of the GOT-F900 Series. Refer to section 3.2.
- \*1 The RS-232C port for the Handy type GOT is provided inside the rear cover. As a result, environmental protection is lost when using this port and such a connection is not practical. (The Handy GOT can be connected as the final unit in a string of two or more GOTs.)

### 10.1.1 Restriction When Computer Link Unit for A Series is Used

When the computer link unit for the A Series shown in the table below is attached to the QnA Series CPU, then the GOT-F900 Series display unit is connected to the QnA Series CPU, there is restriction in the available device range.

- Refer to the description on the MELSEC-QnA Series in section 3.3.

Computer link unit (There is restriction.)	Serial data communication unit (There is no restriction.)
AJ71UC24 A1SJ71UC24-R4	AJ71QC24 AJ71QC24-R4

## 10.2 System Configuration

The QnA Series PLC can be connected to the GOT through a computer link connection (RS-422 or RS-232C) or directly via RS-422. This section explains the cables and options required in such a system.

### 10.2.1 Applicable model

The GOT-F900 can be connected to the following equipment in accordance with its OS version. Operations are not assured when the GOT-F900 is connected to any other equipment. For details of the OS version of the GOT-F900 and applicable equipment, refer to "3.1 OS Version and Correspondence to Connected Equipment of GOT-F900".

CPU	OPTION	COMMUNICATION PORT
	–	Connection to programming port
QnACPU Q4ARCPU Q2AHCPU Q2ASCPU Q2ASH(S1)CPU	AJ71UC24 A1SJ71C24-R4 A1SJ71C24-R2 A1SJ71UC24-R4 A1SJ71UC24-R2	Connection to computer link unit (Excluding the 5V type F920GOT-K.)
	AJ71QC24 AJ71QC24-R4 AJ71QC24-R2 A1SJ71QC24, A1SJ71QC24-R2	Connection to serial communication unit (Excluding the 5V type F920GOT-K.)

1

Introduction

2

Outline

3

Specifications

4

Installation  
and Wiring of  
F940GOT

5

Installation  
and Wiring of  
Handy GOT

6

Connection of  
Peripheral  
Equipment

7

Connection of  
Two or More  
GOT Units

8

Connection of  
MELSEC-FX  
Series PLC

9

Connection of  
MELSEC-A  
Series PLC

10

Connection of  
MELSEC-QnA  
Series PLC

### 10.2.2 Configuration for Direct Connection (RS-422)

Connect the GOT-F900 to the programming port of the QnA Series PLC. Program transfer and monitoring are available in the GOT-F900 Series using the built-in two-port interface function through connection of a personal computer to the RS-232C port. (excluding the F920GOT-K)

#### 1) F920GOT-K/F930GOT/F930GOT-K/F940GOT/F940WGOT

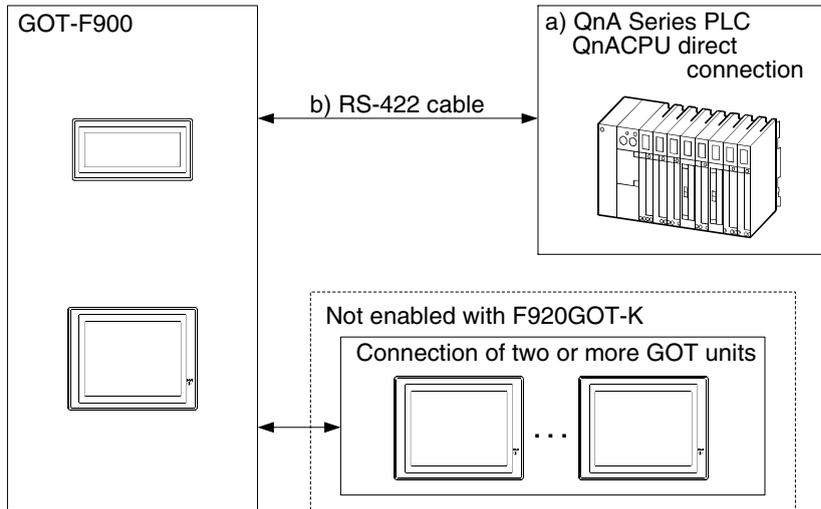

F920GOT-K (5V type)

a) QnA Series PLC	b) RS-422 cable	Remarks
QnACPU direct connection (25-pin D-Sub)	Prepared by the user.	Make sure the total cable extension distance is 3m (9' 10") or less.

F920GOT-K (24V type)/F930GOT/F930GOT-K/F940GOT/F940WGOT

a) QnA Series PLC	b) RS-422 cable	Remarks
QnACPU direct connection (25-pin D-Sub)	FX-40DU-CAB FX-40DU-CAB-□□M FX-50DU-CABL	"□□" in "FX-40DU-CAB-□□M" indicates the cable length.

- Only one of the cables listed in column b) is required for connection.
- In the F930GOT and the F930GOT-K, the FX-50DU-CABL right-angle type (L type) cable can not be used.



2) F940 Handy GOT

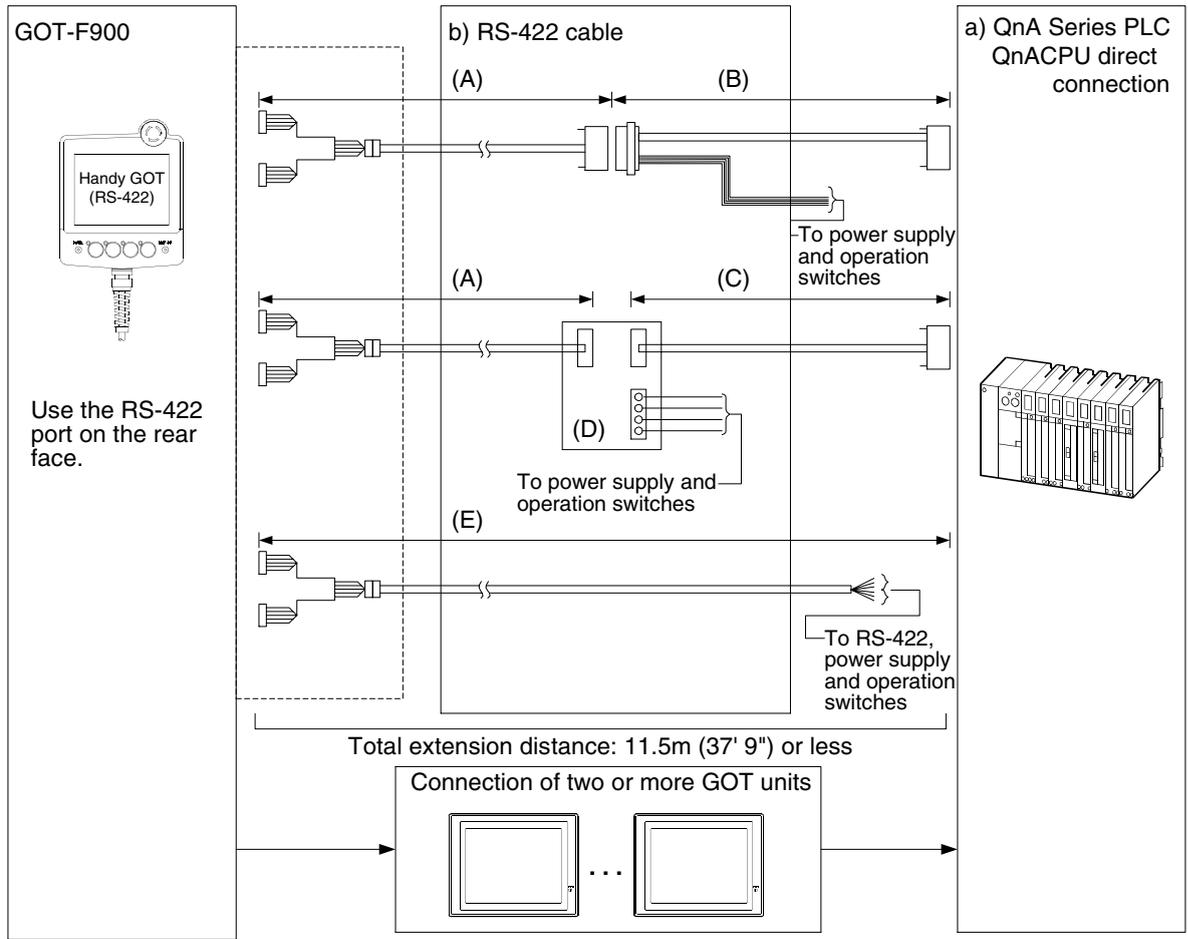

a) QnA Series PLC	b) RS-422 cable	Remarks
QnACPU direct connection (25-pin D-Sub)	(A) F9GT-HCAB-□□M (B) F9GT-HCAB3-150 (C) FX-40DU-CAB (D) F9GT-HCNB (E) F9GT-HCAB1-□□M	

- Make sure that the total cable extension distance "(A) + (B)" or (E) is 11.5m (37' 9") or less.

1	Introduction
2	Outline
3	Specifications
4	Installation and Wiring of F940GOT
5	Installation and Wiring of Handy GOT
6	Connection of Peripheral Equipment
7	Connection of Two or More GOT Units
8	Connection of MELSEC-F FX Series PLC
9	Connection of MELSEC-A Series PLC
10	Connection of MELSEC-QnA Series PLC

### 10.2.3 Configuration for QnA Computer Link Connection (RS-422)

The GOT-F900 and the computer link unit can be connected on the "1:1" basis. Because the programming port of the PLC is not occupied, peripheral programming equipment (dedicated equipment) for PLC can be connected for monitoring and transfer of sequence programs.

#### 1) F920GOT-K (24V type)/F930GOT/F930GOT-K/F940GOT/F940WGOT

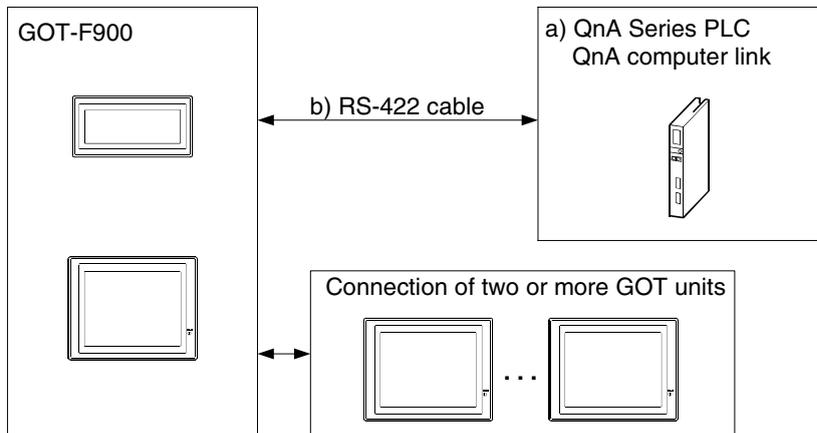

a) QnA Series PLC		b) RS-422 cable	Remarks
AJ71QC24-R4	25-pin D-Sub	Prepared by the user.	Make sure the total cable extension distance is 30m (98' 5") or less.
AJ71QC24 A1SJ71QC24	Terminal block		Make sure the total cable extension distance is 30m (98' 5") or less. Connect the terminating resistors on the computer link unit side.
AJ71UC24 A1SJ71UC24-R4	Terminal block		Connection of two or more GOT units is not possible. Make sure the total cable extension distance is 30m (98' 5") or less. Connect the terminating resistors on the computer link unit side.

- Applicable QnA Series PLC products in the column a) are computer link units equipped with built-in RS-422 interface.

2) F940 Handy GOT

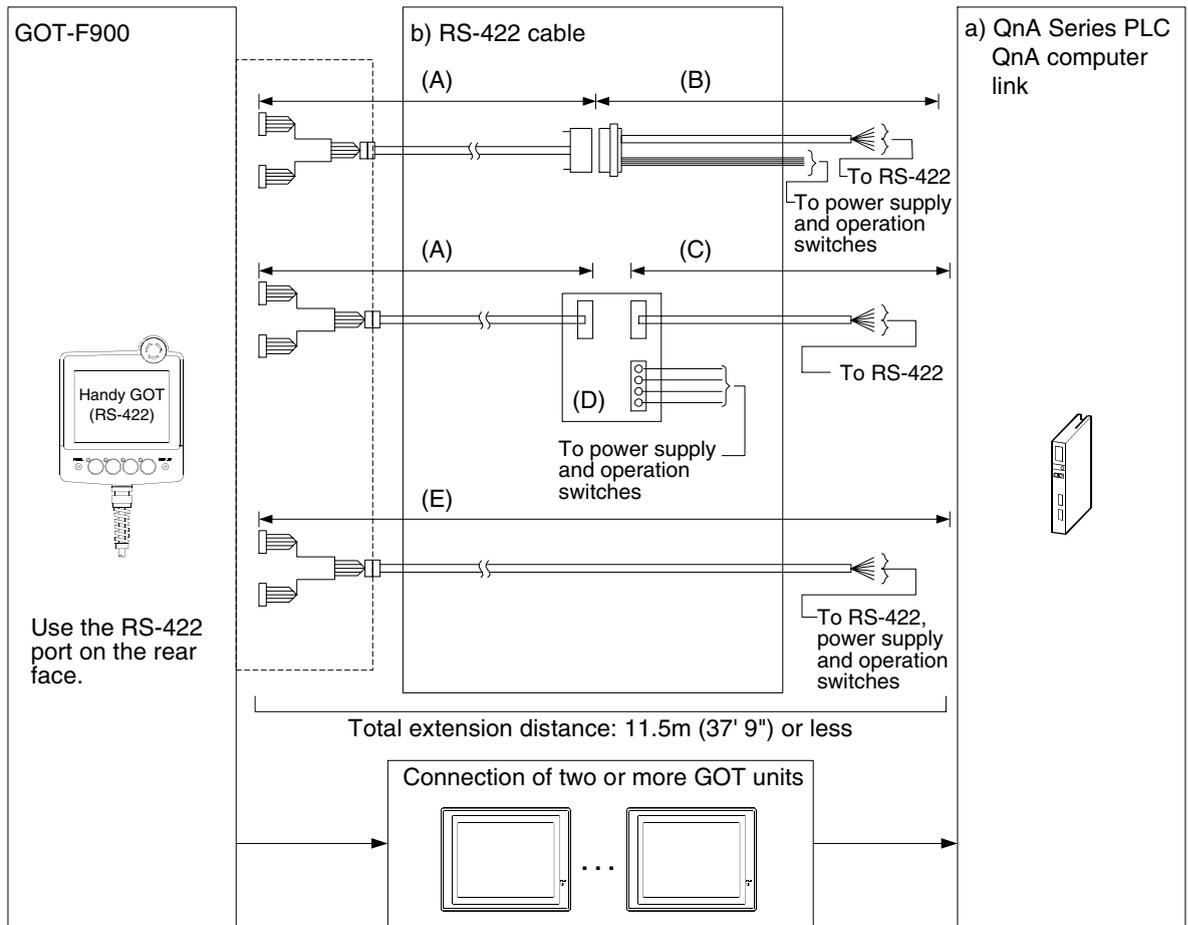

a) QnA Series PLC		b) RS-422 cable	Remarks
AJ71QC24-R4	25-pin D-Sub		
AJ71QC24 A1SJ71QC24	Terminal block	(A) F9GT-HCAB-□□M (B) Prepared by the user.	Connect the terminating resistors on the computer link unit side.
AJ71UC24 A1SJ71UC24-R4	Terminal block	(C) Prepared by the user. (D) F9GT-HCNB (E) F9GT-HCAB1-□□M	Connection of two or more GOT units is not possible. Connect the terminating resistors on the computer link unit side.

- Applicable QnA Series PLC products in the column a) are computer link units equipped with built-in RS-422 interface.
- Make sure that the total cable extension distance "(A) + (B)" or (E) is 11.5m (37' 9") or less.

### 10.2.4 Configuration for QnA Computer Link Connection (RS-232C)

The GOT-F900 and the computer link unit can be connected on the "1:1" basis. Because the programming port of the PLC is not occupied, peripheral programming equipment (dedicated equipment) for PLC can be connected for monitoring and transfer of sequence programs.

#### 1) F920GOT-K (24V type)/F930GOT/F930GOT-K/F940GOT/F940WGOT

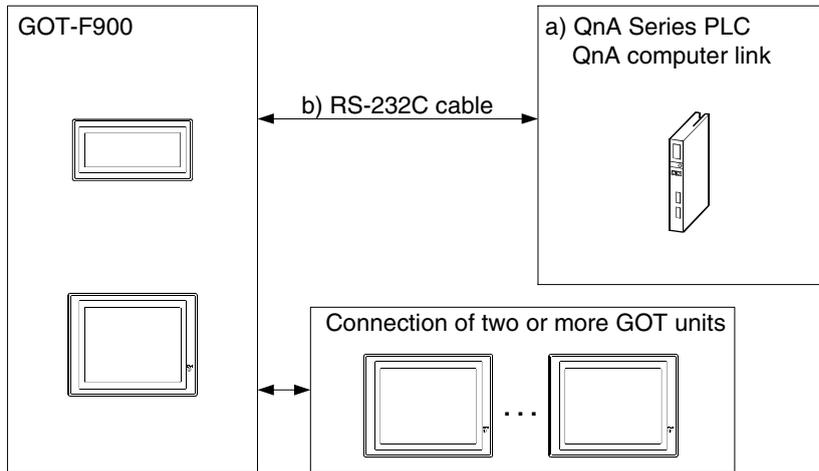

a) QnA Series PLC		b) RS-232C cable	Remarks
AJ71QC24 AJ71QC24-R2	25-pin D-Sub	F2-232CAB-1	
A1SJ71QC24 A1SJ71QC24-R2	9-pin D-Sub	Prepared by the user.	Make sure the total cable extension distance is 15m (49' 3") or less.
A1SJ71UC24-R2			Make sure the total cable extension distance is 15m (49' 3") or less.
AJ71UC24	25-pin D-Sub	F2-232CAB-1	

- Applicable QnA Series PLC products in the column a) are computer link units equipped with built-in RS-232C interface.

2) F943 Handy GOT

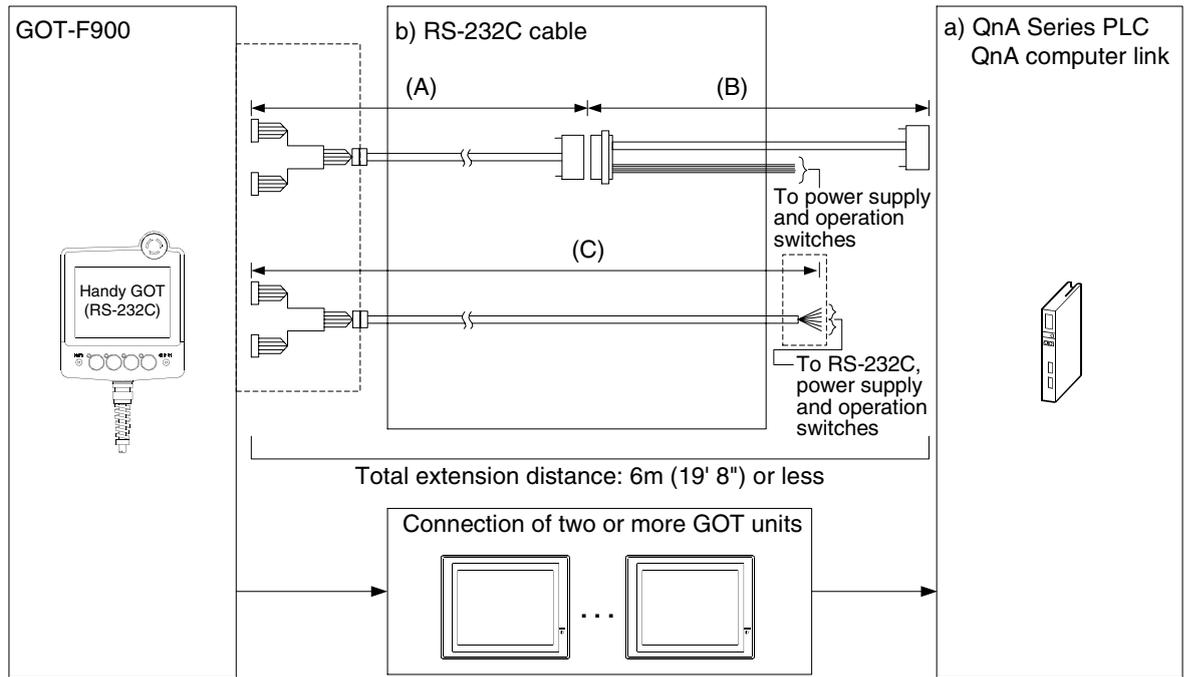

a) QnA Series PLC		b) RS-232C cable	Remarks
AJ71QC24	25-pin D-Sub	(A) F9GT-HCAB-3M	
AJ71QC24-R2		(B) Prepared by the user.	
A1SJ71QC24	9-pin D-Sub	(C) F9GT-HCAB1-3M	
A1SJ71QC24-R2			
A1SJ71UC24-R2	25-pin D-Sub		Connection of two or more GOT units is not possible.
AJ71UC24			

- In the (C)F9GT-HCAB1-3M shown in the column "b) RS-232C cable", the end on the PLC side is loose wires.
- Make sure that the total cable extension distance "(A) + (B)" or (C) is 6m (19' 8") or less.

### 10.3 Setting in QnA Computer Link Connection

In QnA computer link connection, the switches in the computer link unit (shown in the following page) should be set as described below.

Connected equipment [classification in manual]	Remarks
[QnACPU direct connection] Port of QnA CPU, QnAS CPU	Refer to the following setting method.
[QnA computer link] AJ71QC24(RS-422/RS-232C) AJ71QC24-R4(RS-422) AJ71QC24-R2(RS-232C) A1SJ71QC24(RS-422/RS-232C) A1SJ71QC24-R2(RS-232C)	
[A computer link] AJ71UC24(RS-422/RS-232C) A1J71UC24-R4(RS-422) A1J71UC24-R2(RS-232C) AJ71UC24(RS-232C)	Refer to Chapter 9.

#### 10.3.1 Communication Setting Specifications

##### 1) Setting the mode selector switch

Set the mode so that the COM port of the computer link unit connected to the GOT-F900 is set to the dedicated (MC) protocol format 5.

COM port	Set value	Remarks
RS-422	5	
RS-232C	5	

##### 2) Setting the transmission specifications setting switches

Set the transmission specifications setting switches of the computer link unit to realize the transmission specifications shown in the table below. For the switch setting method, refer to the manual of each computer link unit.

Item	Set value	Remarks	
Transmission speed	19,200 bps		
Data format	Data bit	8 bits	The setting is different from A computer link (7 bits).
	Parity bit	Provided (odd)	The setting is different from A computer link (provided, even).
	Stop bit	1 bit	
	Sum check	Provided	
Write in RUN mode	Possible		

- The specifications such as the transmission speed are fixed on the GOT-F900 side, and cannot be changed.

##### 3) Setting the station number setting switches

Match the switches to 0H both in the GOT-F900 and in the computer link unit.

##### 4) Turning on the power again

After setting the QnA computer link, make sure to turn off the power once, then turn it on again. (Even if the RESET switch in the QnA Series PLC is pressed, the changed setting does not become valid.)

### 10.3.2 Setting Examples

#### 5) RS-422 connection

a) When the AJ71QC24(N)(-R4) is connected

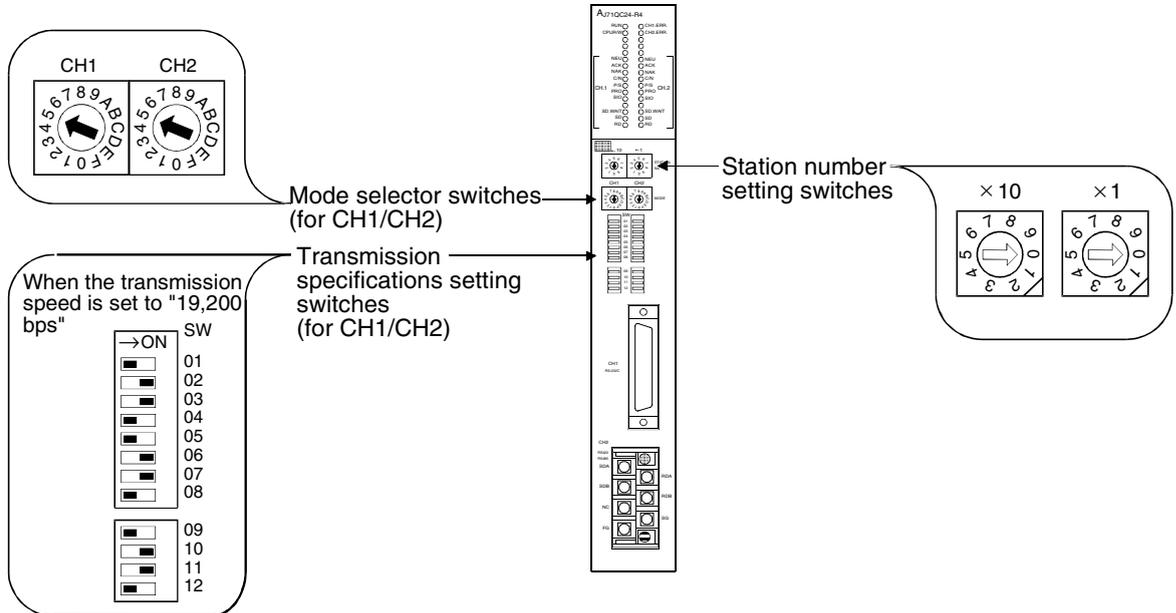

#### Important Point

Set the mode selector switch for the unused channel to any value other than "0 (interlocking operation)".

b) When the A1SJ71QC24(N) is connected

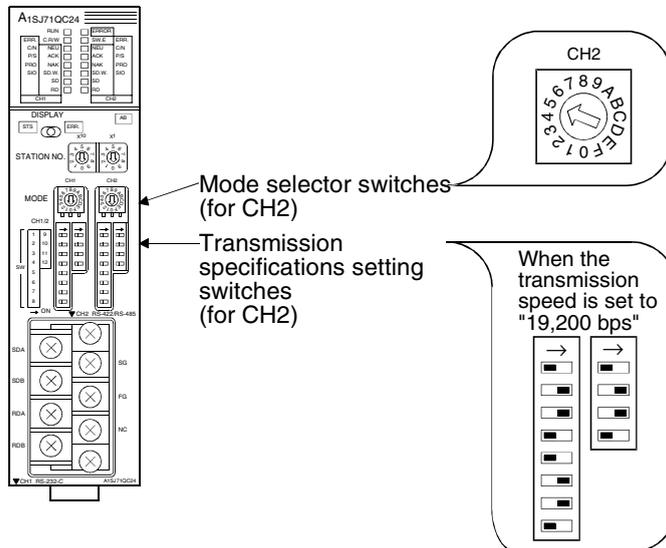

1	Introduction
2	Outline
3	Specifications
4	Installation and Wiring of F940GOT
5	Installation and Wiring of Handy GOT
6	Connection of Peripheral Equipment
7	Connection of Two or More GOT Units
8	Connection of MELSEC-F FX Series PLC
9	Connection of MELSEC-A Series PLC
10	Connection of MELSEC-QnA Series PLC

6) RS-232C connection

a) When the AJ71QC24(-R2) is connected

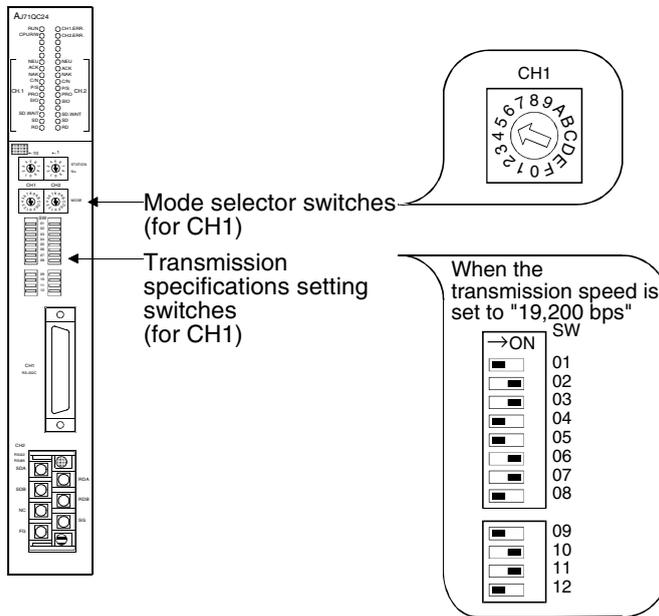

b) When the A1SJ71QC24(N)(-R2) is connected

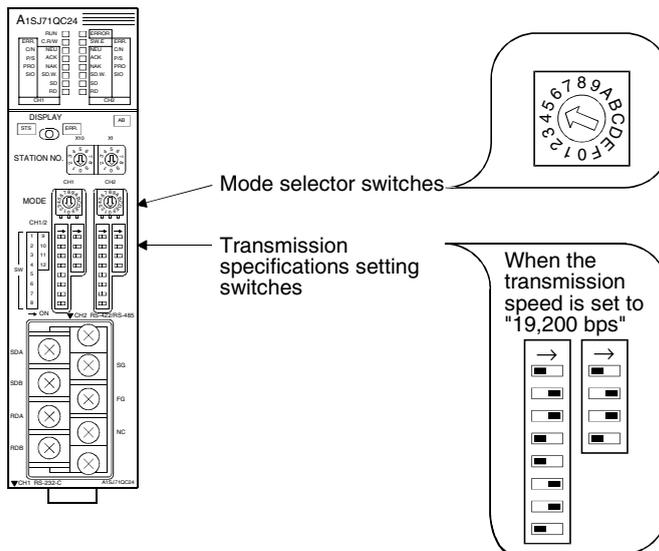



## 10.4 Caution on Use of MELSEC-QnA Series PLC

When using the GOT-F900 connected to the QnA Series PLC, observe the following caution on use.

### 10.4.1 Caution when the GOT is connected to the serial communication unit

#### 1) Simultaneous use of 2 ports

When the GOT is connected, the CH1 and the CH2 of the serial communication unit cannot be used at the same time.

Accordingly, have in mind that connecting both of GOT unit and peripheral equipment for the GPP function or two GOT units to one serial communication unit is not allowed.

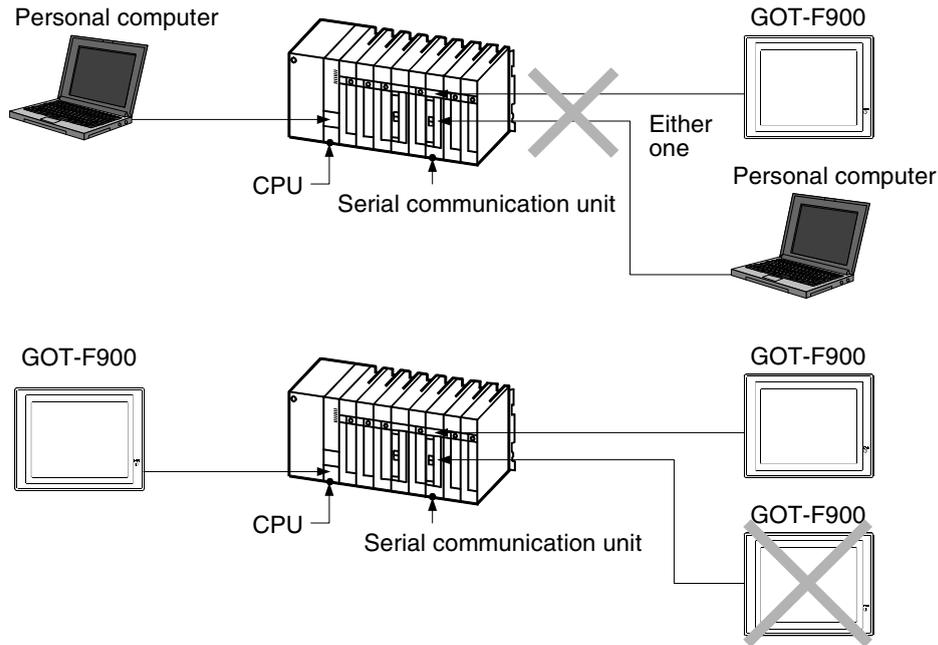

However, a GOT unit or a personal computer can be connected to the RS-422 port of the QnACPU while the computer link unit has one GOT unit.

#### 2) Compatible OS version of QnACPU

When connecting a GOT unit to a serial communication unit or A Series computer link unit, the OS version of QnACPU needs to be later than the version indicated below. (Programming port of CPU is compatible with any version.)

QnACPU	H/W version	S/W version	Production date
Q2A,Q3A,Q4A	D	A	Earlier than March, 1997
Q2AS	A	L	Earlier than March, 1997

### 10.4.2 Caution when the GOT is connected to the computer link for the A Series PLC

- When connecting the GOT-F900 to the A computer link attached to the QnACPU, select A SERIES for PLC TYPE.
- For setting method for the A computer link or screen creation software, refer to Chapter 9.

## 10.5 Setting of Connected Equipment for GOT

The setting for connection to the QnA Series PLC can be executed using the GOT-F900 and the screen creation software (GT Designer2, GT Designer or DU/WIN).

### Setting the Connection Type

Set the connection type in accordance with the connected equipment as shown in the table below. When using the computer link unit for the A Series PLC, select A SERIES for PLC TYPE. (Refer to Chapter 9 for details.)

Have in mind that the computer link unit for the QnA requires CPU direct connection.

Connected equipment [classification in manual]	GOT-F900	Screen creation software	Remarks
	CONNECTION	Type	
[QnACPU direct connection] Port of QnA CPU, QnAS CPU	CPU direct connection (RS-422)		Programming port Refer to the following setting method.
[QnA computer link] AJ71QC24(RS-422/RS-232C) AJ71QC24-R4(RS-422) AJ71QC24-R2(RS-232C) A1SJ71QC24(RS-422/RS-232C) A1SJ71QC24-R2(RS-232C)	CPU direct connection (RS-422) or CPU direct connection (RS-232C)		Communicates as programming port Refer to the following setting method.
[A computer link] AJ71UC24(RS-422/RS-232C) A1J71UC24-R4(RS-422) AJ71UC24(RS-422/RS-232C) A1SJ71C24-R4(RS-422) A1SJ71C24-R2(RS-232C) A1SJ71UC24-R4(RS-422) A1SJ71UC24-R2(RS-232C) A1J71UC24-R2(RS-232C) AJ71UC24(RS-232C)	Link connection (RS-422) or link connection (RS-232C)		Communicates as computer link. Select A SERIES for PLC TYPE Refer to Chapter 9.

**1) GOT-F900 Series**

When the main menu screen change operation is disabled.

Operation		Display (screen name)	
a) While pressing and holding the upper left corner of the screen, turn on the power. Keep holding the upper left corner for about 25 seconds more. Then, press "END" at the upper right corner. b) Press "PLC TYPE". c) Set the following. PLC TYPE: QnA, Q SERIES (QnA CPU, QnA computer link) A SERIES (A computer link) CONNECTION: CPU PORT (RS-422) CPU PORT (RS-232C) LINK PORT (RS-422) LINK PORT (RS-232C) DST STATION # (STATION #) : 00 to 15 GOT STATION # (-) : -		The "LANGUAGE" screen appears.  The "SET-UP MODE" screen appears. The "PLC TYPE" screen appears.	
Connection destination	PLC TYPE	CONNECTION	STATION #
QnACPU direct connection	QnA, Q Series	CPU PORT (RS-422)	0
QnA computer link unit	QnA, Q Series	CPU PORT (RS-422) CPU PORT (RS-232C)	0
A computer link unit	A Series or QnA, Q Series	LINK PORT (RS-422) LINK PORT (RS-232C)	0 to 15

1	Introduction
2	Outline
3	Specifications
4	Installation and Wiring of F940GOT
5	Installation and Wiring of Handy GOT
6	Connection of Peripheral Equipment
7	Connection of Two or More GOT Units
8	Connection of MELSEC-F FX Series PLC
9	Connection of MELSEC-A Series PLC
10	Connection of MELSEC-QnA Series PLC

When the main menu screen change operation is enabled.

Operation				Display (screen name)
a) Press the upper left corner of the screen. (The position to be pressed can be changed in the GOT and the screen creation software.) b) Press "OTHER MODE" on the menu. c) Press "SET-UP MODE" on the menu. d) Press "PLC TYPE". e) Set the following. PLC TYPE: QnA, Q SERIES (QnA CPU, QnA computer link) A SERIES (A computer link) CONNECTION: CPU PORT (RS-422) CPU PORT (RS-232C) LINK PORT (RS-422) LINK PORT (RS-232C) DST STATION # (STATION #) : 00 to 15 GOT STATION # (-) : -				The "SELECT MODE" screen appears.  The "OTHER MODE" screen appears. The "SET-UP MODE" screen appears. The "PLC TYPE" screen appears.
Connection destination	PLC TYPE	CONNECTION	STATION #	
QnACPU direct connection	QnA, Q Series	CPU PORT (RS-422)	0	
QnA computer link unit	QnA, Q Series	CPU PORT (RS-422) CPU PORT (RS-232C)	0	
A computer link unit	A Series or A, QnA Series	LINK PORT (RS-422) LINK PORT (RS-232C)	0 to 15	

- When the screen data is transferred to the GOT-F900, the old data including the PLC type, connection type, and station number are overwritten.
- The "PLC type" selection item display varies depending on the OS version as follows.

GOT-F900		"PLC TYPE" selection item display in GOT			
		A SERIES	A, QnA SERIES	A SERIES *1 QnA, Q SERIES	A SERIES *1 QnA, Q SERIES Q (Multi) SERIES
OS version	F940WGOT	-	-	1.00 or later	1.30 or later
	F940GOT, Handy GOT	1.00 or later	3.00 or later	4.10 or later	6.30 or later
	F930GOT-K	-	-	4.60 or later	4.60 or later
	F930GOT	1.00 or later	2.00 or later	2.20 or later	4.30 or later
	F920GOT-K	-	-	1.00 or later	1.00 or later
Connection setting availability		Not available (A computer link connection is available.)	Available	Available (Select "QnA, Q SERIES".)	Available (Select "QnA, Q SERIES".)

\*1 Note that the selection item on the menu is changed from "A, QnA SERIES" to "A SERIES" and "QnA, Q SERIES".

2) GT Designer2

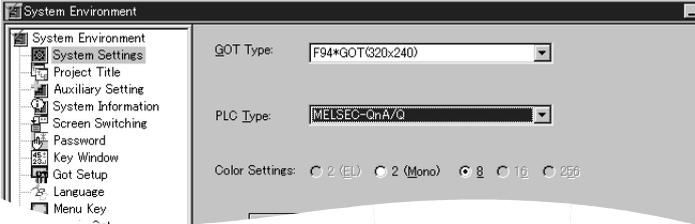
	Operation	Display (screen name)										
[Creation]	<p>a) Open GT Designer2.</p> <p>b) Click the [NEW] button. The dialog box shown below is displayed. If it is not displayed, click "System Environment" in the tree displayed in the project work space, then click "System settings" in the tree.</p>  <p>c) Set the following.</p> <p>GOT type: F940WGOT (480 × 234) F94*GOT (320 × 240) F93*GOT (240 × 80) F920GOT (128 × 64)</p> <p>PLC type: MELSEC-QnA, Q (QnA CPU, QnA computer link) MELSEC-A (A computer link)</p> <p>Selection of "GOT type"</p> <table border="1" data-bbox="485 1021 1114 1279"> <thead> <tr> <th>GOT type</th> <th>Model name (name)</th> </tr> </thead> <tbody> <tr> <td>F940WGOT(480×234)&lt;WIDE&gt;</td> <td>F940WGOT</td> </tr> <tr> <td>F94*GOT(320×240)</td> <td>F940GOT Handy GOT</td> </tr> <tr> <td>F93*GOT(240×80)</td> <td>F930GOT F930GOT-K</td> </tr> <tr> <td>F920GOT(128×64)</td> <td>F920GOT-K</td> </tr> </tbody> </table> <p>Click [OK].</p>	GOT type	Model name (name)	F940WGOT(480×234)<WIDE>	F940WGOT	F94*GOT(320×240)	F940GOT Handy GOT	F93*GOT(240×80)	F930GOT F930GOT-K	F920GOT(128×64)	F920GOT-K	<p>The "Select Project" dialog box appears.</p> <p>The "System Environment" dialog box appears.</p>
GOT type	Model name (name)											
F940WGOT(480×234)<WIDE>	F940WGOT											
F94*GOT(320×240)	F940GOT Handy GOT											
F93*GOT(240×80)	F930GOT F930GOT-K											
F920GOT(128×64)	F920GOT-K											

1	Introduction
2	Outline
3	Specifications
4	Installation and Wiring of F940GOT
5	Installation and Wiring of Handy GOT
6	Connection of Peripheral Equipment
7	Connection of Two or More GOT Units
8	Connection of MELSEC-F FX Series PLC
9	Connection of MELSEC-A Series PLC
10	Connection of MELSEC-QnA Series PLC

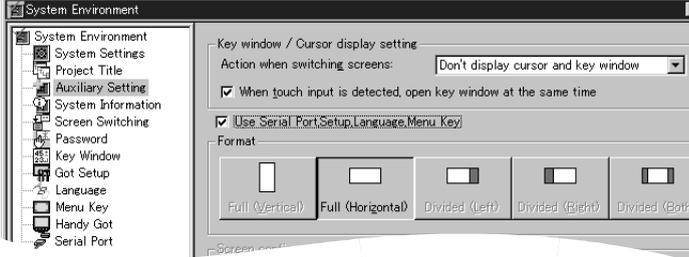
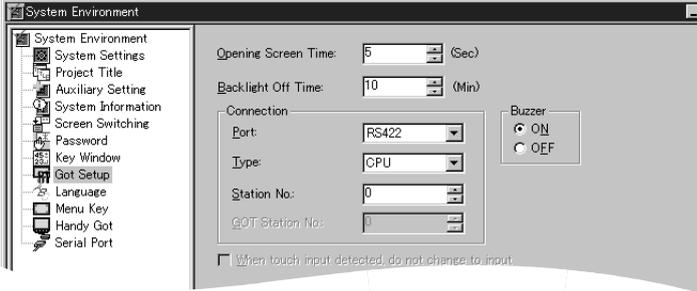
	Operation	Display (screen name)															
	<p>d) Setting the port (RS-422 or RS-232C) of the GOT-F900</p> <p>Click "Auxiliary Settings" in the tree of the system environment menu.</p> <p>Click the check box of "Use Serial Port, Setup, Language, Menu Key" to give a check mark (✓).</p>  <p>Click "Got Setup" in the tree of the system environment menu.</p>  <p>e) Set the following.</p> <p>Port : RS-422 RS-232C</p> <p>Type : CPU LINK</p> <p>Station No. : 00 to 15 GOT Station No. : -</p> <p>In the case of F943 Handy GOT Without regard to the port setting (RS-422 or RS-232C), the COM0 side of the RS-232C is fixed for PLC connection. Combinations of "Port" and "Type" are as follows.</p> <table border="1" data-bbox="472 1375 1102 1619"> <thead> <tr> <th>Connection destination</th> <th>Port</th> <th>Type</th> </tr> </thead> <tbody> <tr> <td>QnA CPU direct connection</td> <td rowspan="3">RS-422</td> <td>CPU</td> </tr> <tr> <td>A computer link unit</td> <td>LINK</td> </tr> <tr> <td>QnA computer link unit</td> <td>CPU</td> </tr> <tr> <td>A computer link unit</td> <td rowspan="2">RS-232C</td> <td>LINK</td> </tr> <tr> <td>QnA computer link unit</td> <td>CPU</td> </tr> </tbody> </table>	Connection destination	Port	Type	QnA CPU direct connection	RS-422	CPU	A computer link unit	LINK	QnA computer link unit	CPU	A computer link unit	RS-232C	LINK	QnA computer link unit	CPU	<p>The "Auxiliary Settings" dialog box appears.</p>
Connection destination	Port	Type															
QnA CPU direct connection	RS-422	CPU															
A computer link unit		LINK															
QnA computer link unit		CPU															
A computer link unit	RS-232C	LINK															
QnA computer link unit		CPU															
<p>[Change method]</p>	<p>Change the connection type of the already created data as follows.</p> <p>a) Open GT Designer2.</p> <p>b) Click the [Project]-[Open] button.</p> <p>c) Open (read) the screen data to be changed.</p> <p>d) On the menu, select "Common"- "System Environment".</p> <ul style="list-style-type: none"> <li>- For the contents of setting, refer to c) of [Creation] above.</li> <li>- For selection of the RS-422 or the RS-232C on the QnA Series PLCs, refer to e) of [Creation] above.</li> </ul>	<p>The "Select Project" dialog box appears.</p> <p>The "System Environment" dialog box appears.</p>															

3) GT Designer

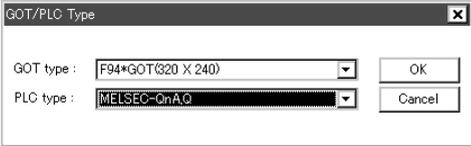
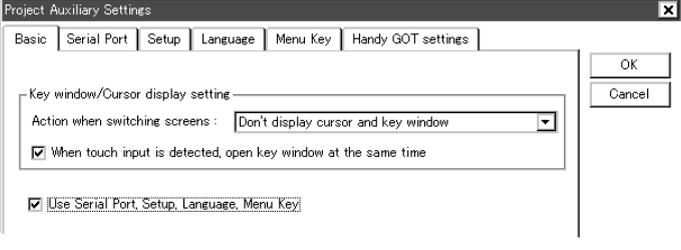
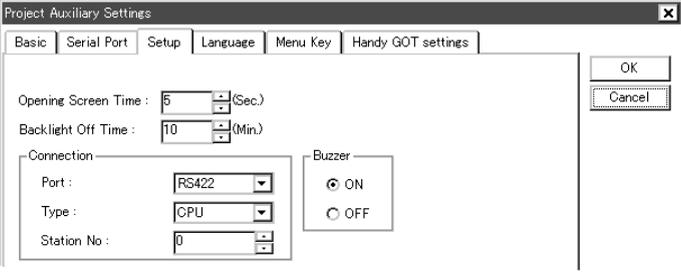
Operation	Display (screen name)										
<p>[Creation]</p> <p>a) Open the GT Designer.</p> <p>b) Click the [New] button.</p>  <p>c) Set the following.            GOT type: F940WGOT (480 × 234) &lt;WIDE&gt;                      F94*GOT (320 × 240)                      F93*GOT (240 × 80)                      F920GOT (128 × 64)            PLC type: MELSEC-QnA, Q (QnA CPU, QnA computer link)                      MELSEC-A (A computer link)</p> <p>Selection of "GOT type"</p> <table border="1" data-bbox="497 842 1104 1099"> <thead> <tr> <th>GOT type</th> <th>Model name</th> </tr> </thead> <tbody> <tr> <td>F940WGOT(480×234)&lt;WIDE&gt;</td> <td>F940WGOT</td> </tr> <tr> <td>F94*GOT(320×240)</td> <td>F940GOT Handy GOT</td> </tr> <tr> <td>F93*GOT(240×80)</td> <td>F930GOT-K F930GOT</td> </tr> <tr> <td>F920GOT(128×64)</td> <td>F920GOT-K</td> </tr> </tbody> </table> <p>Click [OK].</p> <p>d) Set CPU direct connection (RS-422/RS-232C)/link connection (RS-422/RS-232C) of the GOT-F900.            This setting is enabled in the SW4D5C-GOTR-PACKE version A or later.            Click the check box of "Use Serial Port, Setup, Language, Menu Key" to give a check mark (✓).</p>  <p>Click the "Setup" tab.</p> 	GOT type	Model name	F940WGOT(480×234)<WIDE>	F940WGOT	F94*GOT(320×240)	F940GOT Handy GOT	F93*GOT(240×80)	F930GOT-K F930GOT	F920GOT(128×64)	F920GOT-K	<p>The "Select Project" dialog box appears.</p> <p>The "GOT/PLC Type" dialog box appears.</p> <p>The "Project Auxiliary Settings" dialog box appears.</p>
GOT type	Model name										
F940WGOT(480×234)<WIDE>	F940WGOT										
F94*GOT(320×240)	F940GOT Handy GOT										
F93*GOT(240×80)	F930GOT-K F930GOT										
F920GOT(128×64)	F920GOT-K										

1	Introduction
2	Outline
3	Specifications
4	Installation and Wiring of F940GOT
5	Installation and Wiring of Handy GOT
6	Connection of Peripheral Equipment
7	Connection of Two or More GOT Units
8	Connection of MELSEC-FX Series PLC
9	Connection of MELSEC-A Series PLC
10	Connection of MELSEC-QnA Series PLC

Operation		Display (screen name)															
	<p>In the case of SW4D5C-GOTR-PACKE earlier than version A, perform the setting in the GOT-F900. (Set the connection in "CONNECTION" in the GOT-F900.) For the setting method, refer to "1) GOT-F900 Series" on the previous page.</p> <p>e)Set the following.                      Port : RS-422                            RS-232C                      Type : CPU                            LINK                      DST Station No. (Station No.): 00 to 15                      GOT Station No. (-) : -</p> <p><u>In the case of and F943 Handy GOT</u>                      Without regard to the port setting (RS-422 or RS-232C), the COM0 side of the RS-232C is fixed for PLC connection.</p> <p>Combinations of "Port" and "Type" are as follows.</p> <table border="1"> <thead> <tr> <th>Connection destination</th> <th>Port</th> <th>Type</th> </tr> </thead> <tbody> <tr> <td>QnA CPU direct connection</td> <td rowspan="3">RS-422</td> <td>CPU</td> </tr> <tr> <td>A computer link unit</td> <td>LINK</td> </tr> <tr> <td>QnA computer link unit</td> <td>CPU</td> </tr> <tr> <td>A computer link unit</td> <td rowspan="2">RS-232C</td> <td>LINK</td> </tr> <tr> <td>QnA computer link unit</td> <td>CPU</td> </tr> </tbody> </table>	Connection destination	Port	Type	QnA CPU direct connection	RS-422	CPU	A computer link unit	LINK	QnA computer link unit	CPU	A computer link unit	RS-232C	LINK	QnA computer link unit	CPU	
Connection destination	Port	Type															
QnA CPU direct connection	RS-422	CPU															
A computer link unit		LINK															
QnA computer link unit		CPU															
A computer link unit	RS-232C	LINK															
QnA computer link unit		CPU															
[Change method]	<p>Change the connection type of the already created data as follows.</p> <p>a)Open the GT Designer.                      b)Click the [Open] button.                      c)Open (read) the screen data to be changed.                      d)On the menu, select "Common"-&gt;"GOT/PLC Type".                      - For the contents of setting, refer to c) of [Creation] above.                      - For selection of the RS-422 or the RS-232C on the QnA Series PLCs, refer to e) of [Creation] above.</p>	<p>The "Select Project" dialog box appears.</p> <p>The "GOT/PLC Type" dialog box appears.</p>															

- The "PLC type" selection item display varies depending on the software version as follows.

GT Designer	"PLC type" selection item display in GT Designer			
	MELSEC-A	MELSEC-A,QnA	MELSEC-A *1 MELSEC-QnA,Q	MELSEC-A MELSEC-QnA,Q MELSEC-Q(Multi)
Version	SW1-A or later	SW2-A or later	SW4-F or later	SW5-P or later (5.13P)
Connection setting availability	Not available (A computer link connection is available.)	Available	Available (Select "MELSEC-QnA,Q".)	Available (Select "MELSEC-QnA,Q".)

\*1 Note that the selection item display is changed from "MELSEC-A, QnA" to "MELSEC-A" and "MELSEC-QnA, Q".





Operation		Display (screen name)																					
	<p>e)Set the following.                      Port: RS-422                      RS-232C                      Type: CPU                      LINK                      DST Station No. (Station No.): 0 to 15                      GOT Station No. (-) : -                      In the case of F943 Handy GOT                      Without regard to the port setting (RS-422 or RS-232C), the COM0 side of the RS-232C is fixed for PLC connection.                      Combinations of "Port" and "Type" are as follows.</p> <table border="1"> <thead> <tr> <th>Connection destination</th> <th>Port</th> <th>Type</th> <th>Station number</th> </tr> </thead> <tbody> <tr> <td>QnA CPU direct connection</td> <td rowspan="3">RS-422</td> <td>CPU</td> <td>0</td> </tr> <tr> <td>A computer link unit</td> <td>LINK</td> <td>0 to 15</td> </tr> <tr> <td>QnA computer link unit</td> <td>CPU</td> <td>0</td> </tr> <tr> <td>A computer link unit</td> <td rowspan="2">RS-232C</td> <td>LINK</td> <td>0 to 15</td> </tr> <tr> <td>QnA computer link unit</td> <td>CPU</td> <td>0</td> </tr> </tbody> </table>	Connection destination	Port	Type	Station number	QnA CPU direct connection	RS-422	CPU	0	A computer link unit	LINK	0 to 15	QnA computer link unit	CPU	0	A computer link unit	RS-232C	LINK	0 to 15	QnA computer link unit	CPU	0	
Connection destination	Port	Type	Station number																				
QnA CPU direct connection	RS-422	CPU	0																				
A computer link unit		LINK	0 to 15																				
QnA computer link unit		CPU	0																				
A computer link unit	RS-232C	LINK	0 to 15																				
QnA computer link unit		CPU	0																				
[Change method]	<p>Change the connection type of the already created data as follows.                      a)Open the DU/WIN.                      b)On the menu, select "File"-&gt;"Open".                      c)Select and open (read) the file of the screen data to be changed.                      d)When changing "Terminal" (GOT-F900), select "View/Project"-&gt;"System Settings"-&gt;"Project settings" on the menu.                      - For the contents of setting, refer to c) of [Creation] above.                      - For selection of the RS-422 or the RS-232C on the QnA Series PLCs, refer to e) of [Creation] above.</p>	<p>The "Open" dialog box appears.                      The "Project settings" dialog box appears.</p>																					

- The "PLC" selection item display varies depending on the software version as follows.

DU/WIN	"PLC System" selection item display in DU/WIN		
	MELSEC-A	MELSEC-A,QnA	MELSEC-A *1 MELSEC-QnA, Q
Version	2.00 or later	2.30 or later	2.40 or later
Connection setting availability	Not available (A computer link connection is available.)	Available	Available (Select "MELSEC-QnA,Q".)

\*1 Note that the selection item display is changed from "MELSEC-A, QnA" to "MELSEC-A" and "MELSEC-QnA, Q".

## 10.6 Cable Diagram

This section explains cable diagrams to connect the GOT-F900 and the QnA Series PLC.

### 10.6.1 Cautions on preparing cables

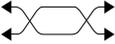
- 1) When preparing the cables, use the wire size of 0.08mm<sup>2</sup> or more (AWG28 or more) for communication, 0.3mm<sup>2</sup> or more (AWG22 or more) for the power supply, operation switch, and emergency stop switch.
- 2)  stands for a twisted pair cable. Prepare a twisted pair cable in combination of the pin numbers and signal lines described on the cable diagram.  
Do not use a twisted pair cable with the power supply wire and the communication wire.

### 10.6.2 Cable diagram

#### 1) Cable for the GOT and the QnA Series PLC

F920GOT-K (5V type)

 : Female type    : Male type   The connector figure shows the engagement face.

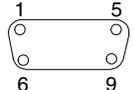
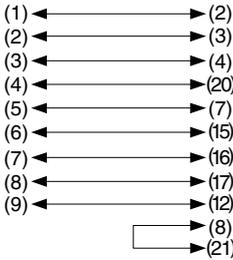
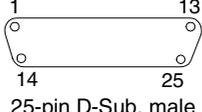
No.	Model name	Application	Connection diagram	Application
a)	<p>RS-422 connection</p> <p><u>QnA CPU direct connection</u> Prepared by the user (Cable length 3m (9'10") or less)</p> <p>Resistance per wire: 0.67 Ω or less (Approximately AWG 28 or thicker)</p>	<p>To GOT-F900</p>  <p>9-pin D-Sub, male</p>		<p>To QnA Series</p>  <p>25-pin D-Sub, male</p>

1	Introduction
2	Outline
3	Specifications
4	Installation and Wiring of F940GOT
5	Installation and Wiring of Handy GOT
6	Connection of Peripheral Equipment
7	Connection of Two or More GOT Units
8	Connection of MELSEC-FX Series PLC
9	Connection of MELSEC-A Series PLC
10	Connection of MELSEC-QnA Series PLC

F920GOT-K (24V type)/F930GOT/F930GOT-K/F940GOT/F940WGOT

: Female type : Male type The connector figure shows the engagement face.

No.	Model name	Application	Connection diagram	Application
a)	<p><b>RS-422 connection</b></p> <p>QnACPU direct connection                      FX-40DU-CAB                      FX-40DU-CAB-10M                      FX-40DU-CAB-20M                      FX-40DU-CAB-30M                      FX-50DU-CABL</p>	To GOT-F900		To QnA Series
b)	<p><b>RS-422 connection</b></p> <p>A, QnA computer link</p> <p>Connect the terminating resistors on the computer link unit side. For details, refer to the User's manual of the computer link unit.</p>	To GOT-F900		To computer link unit side (PLC side)
c)	<p><b>RS-232C connection</b></p> <p>A computer link                      F2-232CAB-1                      (The connection diagram is partially different)</p>	To GOT-F900		To computer link unit side (PLC side)
d)	<p><b>RS-232C connection</b></p> <p>A, QnA computer link                      Prepared by user</p> <p>If proper monitoring is not executed due to external noise when connecting A1SJ71QC24 (-R2), connect all signals in pair with SG (except SG and FG).</p>	To GOT-F900		To computer link unit side (PLC side)

When the computer link unit for the QnA Series is equipped with the 25-pin D-Sub port, the connection diagram is as follows. (The AJ71QC24-R4 is available).

: Female type : Male type The connector figure shows the engagement face.

No.	Model name	Application	Connection diagram	Application
e)	<p><b>RS-422 connection</b></p> <p>QnA computer link                      Prepared by the user</p>	To GOT-F900		To computer link unit side (PLC side)

2) Cable for the Handy GOT and the QnA Series PLC

When using the Handy GOT RH model, refer to the cable diagrams below for the RS-422/RS-232C connector, but not the wiring for the power supply, the operation switches, and the emergency stop switch because it is different. For details, refer to Section 5.18.

 : Female type  : Male type The connector figure shows the engagement face.

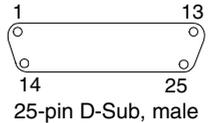
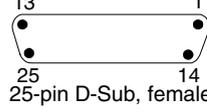
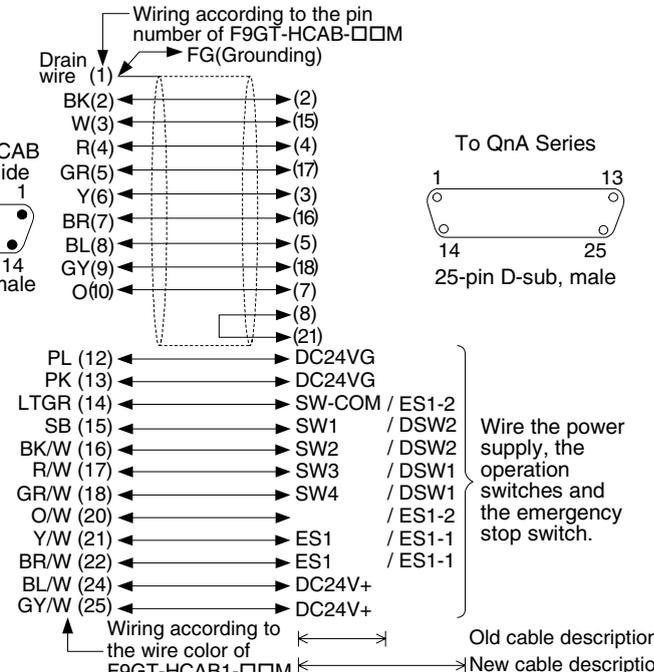
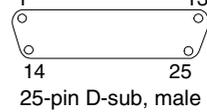
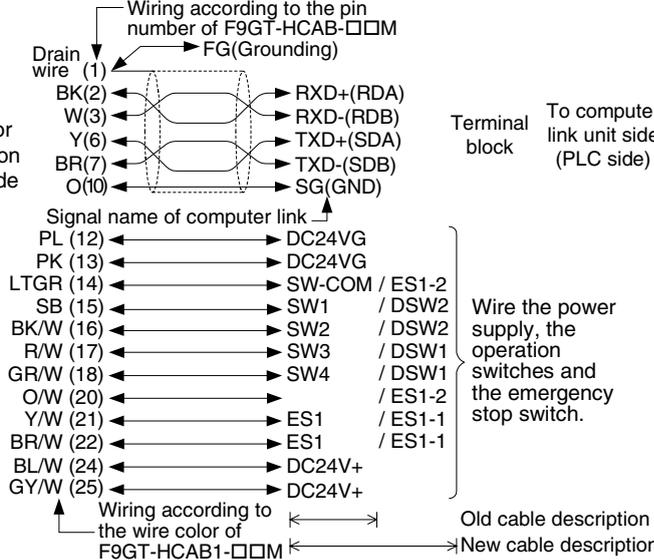
No.	Model name	Application	Connection diagram	Application
a)	F9GT-HCAB-3M F9GT-HCAB-10M	<div style="border: 1px solid black; padding: 2px; display: inline-block;">RS-422 connection</div> <div style="border: 1px solid black; padding: 2px; display: inline-block;">RS-232C connection</div>	Dedicated connector on Handy GOT side  The connector on the leader side of the Handy GOT is dedicated, and cannot be prepared by the user.	To F9GT-HCAB3-150   25-pin D-Sub, male
b)	F9GT-HCAB1-3M F9GT-HCAB1-10M	<div style="border: 1px solid black; padding: 2px; display: inline-block;">RS-422 connection</div> <div style="border: 1px solid black; padding: 2px; display: inline-block;">RS-232C connection</div>	Dedicated connector on Handy GOT side  The connector on the leader side of the Handy GOT is dedicated, and cannot be prepared by the user.	Loose wires (no connector)
c)	F9GT-HCAB3-150	<div style="border: 1px solid black; padding: 2px; display: inline-block;">RS-422 connection</div>  To cable F9GT-HCAB on Handy GOT side  25-pin D-Sub, female	Wiring according to the pin number of F9GT-HCAB-□□□□  Drain wire (1) → FG (Grounding) BK(2) → (2) W(3) → (15) R(4) → (4) GR(5) → (17) Y(6) → (3) BR(7) → (16) BL(8) → (5) GY(9) → (18) O(10) → (7) (8) → (21) PL (12) → DC24VG PK (13) → DC24VG LTGR (14) → SW-COM / ES1-2 SB (15) → SW1 / DSW2 BK/W (16) → SW2 / DSW2 R/W (17) → SW3 / DSW1 GR/W (18) → SW4 / DSW1 O/W (20) → ES1-2 Y/W (21) → ES1 / ES1-1 BR/W (22) → ES1 / ES1-1 BL/W (24) → DC24V+ GY/W (25) → DC24V+ Old cable description ← → New cable description	To QnA Series   25-pin D-sub, male  Wire the power supply, the operation switches and the emergency stop switch.
d)	A, QnA computer link Prepared by the user	<div style="border: 1px solid black; padding: 2px; display: inline-block;">RS-422 connection</div>  To cable F9GT-HCAB or F9GT-HCAB1 on Handy GOT side	Wiring according to the pin number of F9GT-HCAB-□□□□  Drain wire (1) → FG (Grounding) BK(2) → RXD+(RDA) W(3) → RXD-(RDB) Y(6) → TXD+(SDA) BR(7) → TXD-(SDB) O(10) → SG(GND) Signal name of computer link PL (12) → DC24VG PK (13) → DC24VG LTGR (14) → SW-COM / ES1-2 SB (15) → SW1 / DSW2 BK/W (16) → SW2 / DSW2 R/W (17) → SW3 / DSW1 GR/W (18) → SW4 / DSW1 O/W (20) → ES1-2 Y/W (21) → ES1 / ES1-1 BR/W (22) → ES1 / ES1-1 BL/W (24) → DC24V+ GY/W (25) → DC24V+ Old cable description ← → New cable description	Terminal block To computer link unit side (PLC side)  Wire the power supply, the operation switches and the emergency stop switch.

1	Introduction
2	Outline
3	Specifications
4	Installation and Wiring of F940GOT
5	Installation and Wiring of Handy GOT
6	Connection of Peripheral Equipment
7	Connection of Two or More GOT Units
8	Connection of MELSEC-FX Series PLC
9	Connection of MELSEC-A Series PLC
10	Connection of MELSEC-QnA Series PLC

: Female type : Male type The connector figure shows the engagement face.

No.	Model name	Application	Connection diagram	Application
e)	QnA computer link Prepared by the user	RS-422 connection To cable F9GT-HCAB or F9GT-HCAB1 on Handy GOT side	<p>Wiring according to the pin number of F9GT-HCAB-□□□M</p> <p>Drain wire (1) → FG(Grounding)</p> <p>BK(2) → (2) (15)</p> <p>W(3) → (3) (16)</p> <p>Y(6) → (7) (8)</p> <p>BR(7) → (10) (21)</p> <p>O(10) → (2)</p> <p>PL (12) → DC24VG</p> <p>PK (13) → DC24VG</p> <p>LTGR (14) → SW-COM / ES1-2</p> <p>SB (15) → SW1 / DSW2</p> <p>BK/W (16) → SW2 / DSW2</p> <p>R/W (17) → SW3 / DSW1</p> <p>GR/W (18) → SW4 / DSW1</p> <p>O/W (20) → / ES1-2</p> <p>Y/W (21) → ES1 / ES1-1</p> <p>BR/W (22) → ES1 / ES1-1</p> <p>BL/W (24) → DC24V+</p> <p>GY/W (25) → DC24V+</p> <p>Wiring according to the wire color of F9GT-HCAB1-□□□M</p>	<p>To computer link unit side (PLC side)</p> <p>25-pin D-Sub, male</p> <p>Wire the power supply, the operation switches and the emergency stop switch.</p> <p>Old cable description → New cable description</p>
f)	A. QnA computer link Prepared by the user	RS-232C connection To cable F9GT-HCAB or F9GT-HCAB1 on Handy GOT side	<p>Wiring according to the pin number of F9GT-HCAB-□□□M</p> <p>Drain wire (1) → (1) FG Drain wire</p> <p>R(4) → (2) SD(TXD)</p> <p>BK(2) → (3) RD(RXD)</p> <p>Y(6) → (4) RS(RTS)</p> <p>BR(7) → (5) CS(CTS)</p> <p>GR(5) → (6) DR(DSR)</p> <p>O(10) → (7) SG(GND)</p> <p>W(3) → (8) CD(DCD)</p> <p>W(3) → (20) ER(DTR)</p> <p>Signal name of computer link</p> <p>PL (12) → DC24VG</p> <p>PK (13) → DC24VG</p> <p>LTGR (14) → SW-COM / ES1-2</p> <p>SB (15) → SW1 / DSW2</p> <p>BK/W (16) → SW2 / DSW2</p> <p>R/W (17) → SW3 / DSW1</p> <p>GR/W (18) → SW4 / DSW1</p> <p>O/W (20) → / ES1-2</p> <p>Y/W (21) → ES1 / ES1-1</p> <p>BR/W (22) → ES1 / ES1-1</p> <p>BL/W (24) → DC24V+</p> <p>GY/W (25) → DC24V+</p> <p>Wiring according to the wire color of F9GT-HCAB1-□□□M</p>	<p>To computer link unit side (PLC side)</p> <p>25-pin D-Sub, male</p> <p>Wire the power supply, the operation switches and the emergency stop switch.</p> <p>Old cable description → New cable description</p>

: Female type : Male type The connector figure shows the engagement face.

No.	Model name	Application	Connection diagram	Application
g)	<p><b>RS-232C connection</b></p> <p><b>A, QnA computer link</b> Prepared by user</p> <p>If proper monitoring is not executed due to external noise when connecting A1SJ71QC24 (-R2), connect all signals in pair with SG (except SG and FG).</p>	<p>To cable F9GT-HCAB or F9GT-HCAB1 on Handy GOT side</p> <p>Drain wire (1) R(4) BK(2) W(3) O(10) GR(5) Y(6) BR(7)</p>	<p>Wiring according to the pin number of F9GT-HCAB-□□□□</p> <p>FG(Grounding)</p> <p>(1) CD(DCD) (2) RD(RXD) (3) SD(TXD) (4) DR(DTR) (5) SG(GND) (6) DR(DSR) (7) RS(RTS) (8) CS(CTS)</p> <p>Signal name of computer link</p> <p>PL (12) → DC24VG PK (13) → DC24VG LTGR (14) → SW-COM / ES1-2 SB (15) → SW1 / DSW2 BK/W (16) → SW2 / DSW2 R/W (17) → SW3 / DSW1 GR/W (18) → SW4 / DSW1 O/W (20) → / ES1-2 Y/W (21) → ES1 / ES1-1 BR/W (22) → ES1 / ES1-1 BL/W (24) → DC24V+ GY/W (25) → DC24V+</p> <p>Wiring according to the wire color of F9GT-HCAB1-□□□□</p> <p>Old cable description ← → New cable description</p>	<p>To computer link unit side (PLC side)</p> <p>9-pin D-Sub, male</p> <p>Wire the power supply, the operation switches and the emergency stop switch.</p>
h)	<p><b>RS-422 connection</b></p> <p><b>A, QnA computer link</b></p> <p>Connect the terminating resistors on the computer link unit side. For details, refer to the User's manual of the computer link unit.</p>	<p>To F9GT-HCNB</p> <p>9-pin D-Sub, male</p>	<p>FG (Grounding)</p> <p>(1) → RXD+(RDA) (2) → RXD-(RDB) (3) → TXD+(SDA) (4) → TXD-(SDB) (5) → SG(GND)</p> <p>Signal name of computer link</p>	<p>Terminal block</p> <p>To computer link unit side (PLC side)</p>
i)	<p><b>RS-422 connection</b></p> <p><b>QnA computer link</b> Prepared by the user</p>	<p>To F9GT-HCNB</p> <p>9-pin D-Sub, male</p>	<p>FG (Grounding)</p> <p>(1) → (2) (6) → (15) (2) → (3) (7) → (16) (5) → (8) (4) → (21)</p>	<p>To computer link unit side (PLC side)</p> <p>25-pin D-Sub, male</p>
j)	<p><b>RS-232C connection</b></p> <p><b>A computer link</b> F2-232CAB-1 (The connection diagram is partially different)</p>	<p>To F9GT-HCNB</p> <p>9-pin D-Sub, female</p>	<p>(1) → (1)FG (2) → (2)SD(TXD) (3) → (3)RD(RXD) (4) → (4)RS(RTS) (7) → (5)CS(CTS) (6) → (6)DR(DSR) (5) → (7)SG(GND) (8) → (8)CD(DCD) (4) → (20)ER(DTR)</p> <p>Signal name of computer link</p>	<p>To computer link unit side (PLC side)</p> <p>25-pin D-Sub, male</p>

1	Introduction
2	Outline
3	Specifications
4	Installation and Wiring of F940GOT
5	Installation and Wiring of Handy GOT
6	Connection of Peripheral Equipment
7	Connection of Two or More GOT Units
8	Connection of MELSEC-FX Series PLC
9	Connection of MELSEC-A Series PLC
10	Connection of MELSEC-QnA Series PLC

## 10.7 Troubleshooting

For reference, this section summarizes frequently asked questions about connection of the GOT-F900 to the QnA Series PLC.

The slightly different messages may be displayed on the F920GOT-K.

### 1) GOT-F900

Contents of trouble	Check points and countermeasures	OS version			
		F940W	F940	F930	F920
<p>"COMMUNICATION ERROR OCCURS" is displayed when a screen changeover or numeric data input is performed on the GOT-F900 screen by a touch key *1.</p> <p>*1 No touch key is available on the F920GOT-K.</p>	<p>The power of the QnA Series PLC is turned off.</p> <ul style="list-style-type: none"> <li>• Cause Communication is disabled because the power of the QnA Series PLC is turned off.</li> <li>• Countermeasures Turn on the power.</li> </ul> <p>Something is wrong with the cable between the GOT-F900 and the QnA Series PLC.</p> <ul style="list-style-type: none"> <li>• Causes The wrong cable is used or the connection is bad.</li> <li>• Countermeasures Check the cable.</li> </ul>	From first product	From first product	From first product	From first product
<p>"DISPLAY SCREEN IS NOT AVAILABLE." is displayed on the GOT-F900 screen.</p>	<p>Changeover to a nonexistent screen by a touch key or the QnA Series PLC was tried.</p> <ul style="list-style-type: none"> <li>• Cause The changeover destination screen has not been created yet.</li> <li>• Countermeasures Create the screen.</li> </ul>	–	Earlier than 6.00	Earlier than 4.00	–
<p>"DISPLAY SCREEN IS NOT AVAILABLE. (NO. ####)" is displayed on the GOT-F900 screen.</p>	<p>A nonexistent screen was tried to be displayed.</p> <ul style="list-style-type: none"> <li>• Cause The screen No. #### has not been created yet.</li> <li>• Countermeasures Create the screen.</li> </ul>	From first product	6.00 or later	4.00 or later	From first product



Contents of trouble	Check points and countermeasures	OS version			
		F940W	F940	F930	F920
"DISPLAY SCREEN IS NOT AVAILABLE." is displayed on the GOT-F900 screen.	<p>A device that does not exist in the QnA Series PLC was referenced. (Example: While an QnA Series PLC is connected, a device exists only in the Q Series PLC is specified for numeric input.)</p> <ul style="list-style-type: none"> <li>• Cause On the changeover destination screen (excluding the head screen), a nonexistent device in the connected QnA Series PLC is specified.</li> <li>• Countermeasures Check the devices used on the head screen.</li> </ul>				
	<p>When a PLC is not connected, the GOT defaults to the QnA mode.</p> <ul style="list-style-type: none"> <li>• Cause Check for the A or QnA Series was executed, the connection mode was automatically changed over, then the device range was checked. This error occurs when the device range set on the changeover destination screen (excluding the head screen) is beyond the range for the A Series.</li> <li>• Countermeasures Connect the PLC.</li> </ul>	–	Earlier than 6.00	Earlier than 4.00	–
	<p>There is an error on the screen to be displayed.</p> <ul style="list-style-type: none"> <li>• Cause One of the screen objects is placed outside the available screen area.</li> <li>• Countermeasures Check the placement of screen objects.</li> </ul>				
"DISPLAY SCREEN IS NOT AVAILABLE. (NO. #####)" is displayed on the GOT-F900 screen.	<p>The display screen contains an error.</p> <ul style="list-style-type: none"> <li>• Causes A device that does not exist in the connected PLC is referenced on the screen No. ####, or one of the screen objects is placed outside the available screen area.</li> <li>• Countermeasures Check the devices used and placement of screen objects.</li> </ul>	From first product	6.00 or later	4.00 or later	From first product

- 1 Introduction
- 2 Outline
- 3 Specifications
- 4 Installation and Wiring of F940GOT
- 5 Installation and Wiring of Handy GOT
- 6 Connection of Peripheral Equipment
- 7 Connection of Two or More GOT Units
- 8 Connection of MELSEC-FX Series PLC
- 9 Connection of MELSEC-A Series PLC
- 10 Connection of MELSEC-QnA Series PLC

Contents of trouble	Check points and countermeasures	OS version			
		F940W	F940	F930	F920
"DATA IS NOT FOUND." is displayed on the GOT-F900 screen.	There is not data because the unit is new or the memory clear has been executed.  <ul style="list-style-type: none"> <li>• Cause There is no screen data.</li> <li>• Countermeasures Write the screen data using the screen creation software.</li> </ul>				
	A device that does not exist in the QnA Series PLC was referenced. (Example: While the QnA Series PLC was connected, a device provided only in the Q Series PLC was specified for numeric input.)  <ul style="list-style-type: none"> <li>• Cause On the head screen, a nonexistent device in the connected QnA Series PLC is specified. (The head screen is the screen No. 1 in the GT Designer, and the screen No. 0 in the DU/WIN.)</li> <li>• Countermeasures Check the devices used on the head screen.</li> </ul>	–	Earlier than 6.00	Earlier than 4.00	–
	While the QnA Series PLC is not connected, the connection mode for the FX2 Series PLC is selected.  <ul style="list-style-type: none"> <li>• Cause Check for the A or QnA Series was executed, the connection mode was automatically changed over, then the device range was checked. This error occurs when the device range set on the head screen is beyond the range for the A Series. (The head screen is the screen No. 1 in the GT Designer, and the screen No. 0 in the DU/WIN.)</li> <li>• Countermeasures Connect the PLC.</li> </ul>				
	There is not data because the unit is new or the memory clear has been executed.  <ul style="list-style-type: none"> <li>• Cause There is no screen data.</li> <li>• Countermeasures Write the screen data using the screen creation software.</li> </ul>	From first product	6.00 or later	4.00 or later	From first product
"CAN NOT WRITE TO PLC MEMORY." is displayed on the GOT-F900 screen.	This error is not displayed.	Earlier than 1.10	Earlier than 6.10	Earlier than 4.10	–
"CAN NOT WRITE." is displayed on the GOT-F900 screen.	This error is not displayed.	1.10 or later	6.10 or later	4.10 or later	From first product
"CAN NOT USE THE FUNCTION WHILE PROTECTED." is displayed on the GOT-F900 screen.	This error is not displayed.	From first product	From first product	From first product	From first product
"PLC IS RUNNING." is displayed on the GOT-F900 screen.	This error is not displayed.	From first product	From first product	From first product	From first product

2) Software

	Contents of trouble	Check points and countermeasures
Software such as GX Developer and FX/WIN	<p>In the personal computer connected to the GOT-F900, sequence programs cannot be monitored or transferred.</p> <p>Communication with the sequence software is disabled. An error message is displayed (only in QnA CPU direct connection).</p>	<p>QnA PLC, bar code reader or printer is connected.</p> <ul style="list-style-type: none"> <li>• Causes The RS-232C connector to which the personal computer is connected is set to be used for another piece of equipment.</li> <li>• Countermeasures For monitoring or transferring sequence programs, set a bar code reader to invalid and a printer to "DON'T USE". If the PLC is connected, select the GOT-F900 equipped with two built-in RS-232C channels.</li> </ul> <hr/> <p>Something is wrong with the cable between the GOT-F900 and the personal computer.</p> <ul style="list-style-type: none"> <li>• Causes The wrong cable is used or the connection is bad.</li> <li>• Countermeasures Check the cable.</li> </ul>
Screen creation software	<p>Communication with the screen creation software and screen data cannot be transferred.</p>	<p>QnA computer link, bar code reader or printer is connected.</p> <ul style="list-style-type: none"> <li>• Causes The RS-232C connector to which the personal computer is connected is set to be used for another piece of equipment.</li> <li>• Countermeasures In the GOT-F900, select by hand "SELECT MODE"-"OTHER MODE"-"DATA TRANSFER". Or set a bar code reader to invalid and a printer to "DON'T USE".</li> </ul> <hr/> <p>Something is wrong with the cable between the GOT-F900 and the personal computer.</p> <ul style="list-style-type: none"> <li>• Causes The connected cable is not proper. Or cable connection is not correct.</li> <li>• Countermeasures Check the cable.</li> </ul>

1	Introduction
2	Outline
3	Specifications
4	Installation and Wiring of F940GOT
5	Installation and Wiring of Handy GOT
6	Connection of Peripheral Equipment
7	Connection of Two or More GOT Units
8	Connection of MELSEC-F FX Series PLC
9	Connection of MELSEC-A Series PLC
10	Connection of MELSEC-QnA Series PLC

# MEMO

## 11. Connection of MELSEC-Q Series PLC

This chapter explains connection of the GOT-F900 Series display unit to the Q Series PLC (Q mode). When connecting the Q Series PLC in the A mode or in the computer link for A, refer to chapter 9.

### Connection Procedure

This section introduces the procedure to connect the GOT-F900 to the Q Series PLC.

#### 1. Preparation

Item name	Description	Reference
System Condition	You can learn the connection availability as well as the version of the GOT-F900 OS and the screen creation software.	11.1
System Configuration	You can select the configuration between the GOT and the Q Series PLC/computer link unit as well as proper cables.	11.2

#### 2. Setting

Item name	Description	Reference									
QCPU Selection in Direct Connection	In the Q computer link unit, the following setting is required. When Q connection is selected, the GOT-F900 is automatically set to fixed values. No setting is required in the Q Series PLC.	–									
Setting in Q Serial Communication Unit	You can learn the communication specifications and the setting.	11.3									
	<table border="1"> <tr> <td>Communication Setting Specifications</td> <td>The contents of setting of computer link</td> <td>11.3.1</td> </tr> <tr> <td>Setting by GPPW</td> <td>How to set the switches in the computer link unit using the software GX Developer</td> <td>11.3.2</td> </tr> <tr> <td>Used Connectors and Connector Covers</td> <td>The model names and the manufacturer of the connectors used in the GOT-F900 and the serial communication unit</td> <td>11.3.3</td> </tr> </table>	Communication Setting Specifications	The contents of setting of computer link	11.3.1	Setting by GPPW	How to set the switches in the computer link unit using the software GX Developer	11.3.2	Used Connectors and Connector Covers	The model names and the manufacturer of the connectors used in the GOT-F900 and the serial communication unit	11.3.3	
	Communication Setting Specifications	The contents of setting of computer link	11.3.1								
Setting by GPPW	How to set the switches in the computer link unit using the software GX Developer	11.3.2									
Used Connectors and Connector Covers	The model names and the manufacturer of the connectors used in the GOT-F900 and the serial communication unit	11.3.3									
Setting in Q Multi PLC System	You can learn the connection of GOT-F900, setting in screen creation software, and PLC number.	11.4									
Caution on Use of MELSEC-Q Series PLC	You can learn the restrictions in connecting the GOT to the Q Series PLC.	11.5									
Setting of Connected Equipment for GOT	Set the PLC type using the GOT or the screen creation software.	11.6									

#### 3. Others

Item name	Description	Reference
Cable Diagram	Cable diagrams for Q Series PLC/GOT connection	11.7
Troubleshooting	Description of errors and how to fix them	11.8

## 11.1 System Condition

When connecting the Q Series PLC, check the COM port designation, the OS version of the GOT-F900, and the applicable version of the screen creation software.

Compatibility when connecting Q Series PLC

GOT-F900 Series	COM port		Connection type		OS version of GOT-F900	Version of screen creation software		
	RS-422	RS-232C	1:1	Two or more GOT units		GT Designer2	GT Designer	DU/WIN
F920GOT-K(5V)	–	✓	✓	–	1.00	SW1-C	SW4-26C	2.70
F920GOT-K(24V)	✓	✓	✓	–	1.20	SW1-C	–	–
F930GOT	✓	✓	✓	✓	2.20	SW1-C	SW4-F	2.40
F930GOT-K	✓	✓	✓	✓	4.60	SW1-C	SW4-26C	2.70
F940GOT	✓	✓	✓	✓	4.10	SW1-C	SW4-F	2.40
F940WGOT	✓	✓	✓	✓	1.00	SW1-C	SW5-F	2.50
F940 Handy GOT	✓	–	✓	–*1	4.10	SW1-C	SW4-F	2.40
F943 Handy GOT	–	✓	✓	–*1	4.10	SW1-C		

The following versions or later are compatible with Q00JCPU/Q00CPU/Q01CPU and Q multi PLC system.

The versions of F920GOT-K and F930GOT-K are the same with the OS versions in the table above.

Compatible with	OS version			Version of screen creation software		
	F930GOT	F940GOT F94□ Handy GOT	F940WGOT	GT Designer2	GT Designer	DU/WIN
Q00JCPU, Q00CPU, Q01CPU	4.30	6.30	1.30	SW1-A (Ver1.00A)	SW5-P (Ver5.13P)	–
Q multiple CPU system						

- "△" in this table indicates that only connection via the programming port of the Q CPU is available, and connection to a serial communication unit is not available.

- The screen creation software version corresponds to the model of the GOT-F900 Series. Refer to section 3.2.

\*1 The RS-232C port for the Handy type GOT is provided inside the rear cover. As a result, environmental protection is lost when using this port and such a connection is not practical. (The Handy GOT can be connected as the final unit in a string of two or more GOTs.)

## 11.2 System Configuration

The Q Series PLC can be connected to the GOT through a serial communication unit connection (RS-422 or RS-232C) or directly via RS-232C. This section explains the cables and options required in such a system.

### 11.2.1 Applicable model

The GOT-F900 can be connected to the following equipment in accordance with its OS version. Operations are not assured when the GOT-F900 is connected to any other equipment. For details of the OS version of the GOT-F900 and applicable equipment, refer to "3.1 OS Version and Correspondence to Connected Equipment of GOT-F900".

CPU	OPTION	COMMUNICATION PORT
Q02CPU Q02HCPU Q06HCPU Q12HCPU Q25HCPU Q00JCPU Q00CPU Q01CPU	—	Connection to programming port
	QJ71C24N QJ71C24 QJ71C24-R2	Connection to serial communication unit (Excluding the 5V type F920GOT-K.)

- Connection to QnU CPU is not allowed.

11

Connection of  
MELSEC-Q  
Series PLC

12

Connection of  
FX Series  
Positioning

13

Connection of  
FREQROL  
Inverter

14

Connection of  
Microcom-  
puter

15

Connection of  
SYSMAC C  
Series PLC

16

Connection of  
FLEX-PC N  
Series PLC

17

Connection of  
Machine Con-  
troller

18

Connection of  
FP Series PLC

19

Connection of  
SLC500  
Series PLC

20

Connection of  
SIMATIC S7  
Series PLC

### 11.2.2 Configuration for Direct Connection (RS-232C)

Connect the GOT-F900 to the programming port of the Q Series PLC.

#### 1) F920GOT-K/F930GOT/F930GOT-K/F940GOT/F940WGOT

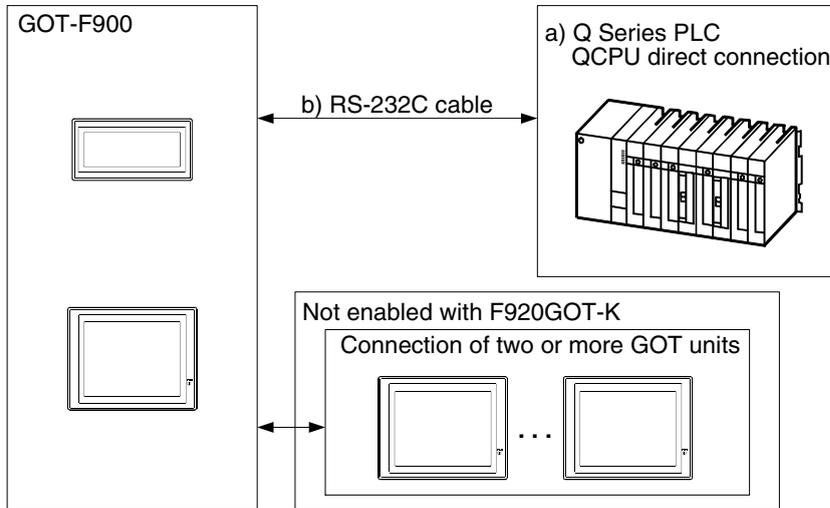

F920GOT-K (5V type)

a) Q Series PLC	b) RS-232C cable	Remarks
QCPU direct connection (6-pin MINI DIN)	Prepared by the user.	Make sure the total cable extension distance is 3m (9' 10") or less.

F920GOT-K (24V type)/F930GOT/F930GOT-K/F940GOT/F940WGOT

a) Q Series PLC	b) RS-232C cable	Remarks
QCPU direct connection (6-pin MINI DIN)	QC30R2	-



2) F943 Handy GOT

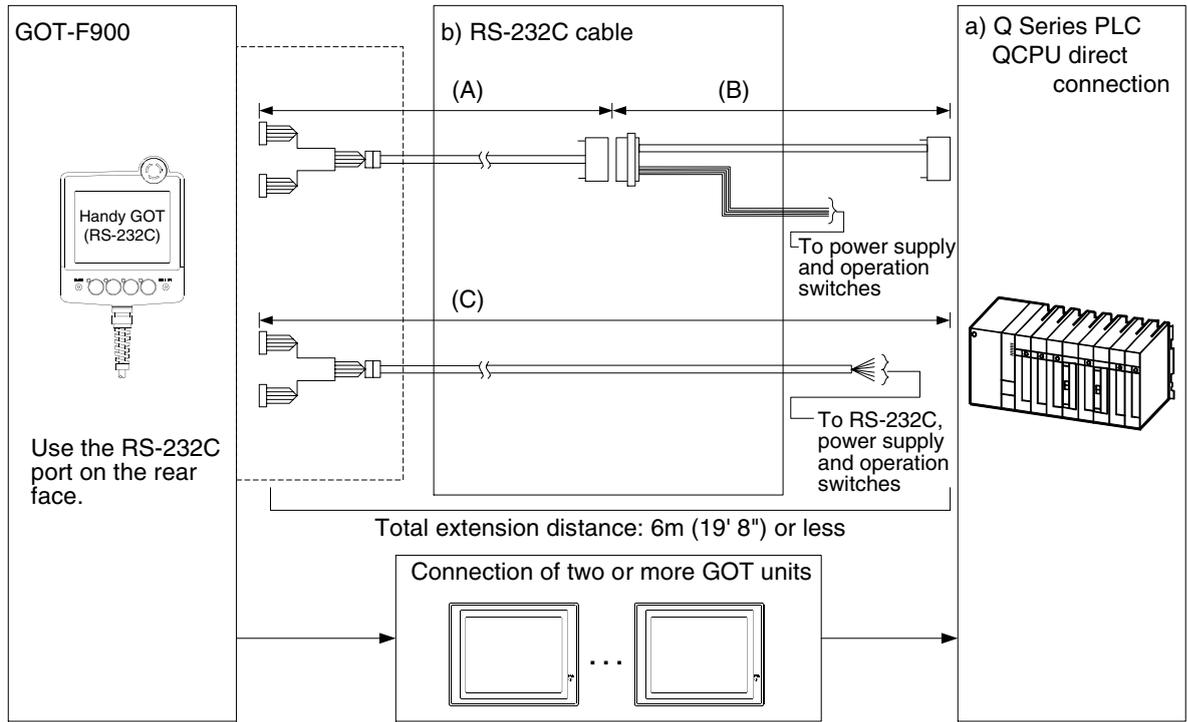

a) Q Series PLC	b) RS-232C cable	Remarks
QCPU (6-pin MINI DIN)	(A) F9GT-HCAB-□□M (B) F9GT-HCAB5-150 (C) F9GT-HCAB1-□□M	-

- Make sure that the total cable extension distance "(A) + (B)" or (C) is 6m (19' 8") or less.

11 Connection of MELSEC-Q Series PLC

12 Connection of FX Series Positioning

13 Connection of FREQROL Inverter

14 Connection of Micro-computer

15 Connection of SYSMAC C Series PLC

16 Connection of FLEX-PC N Series PLC

17 Connection of Machine Controller

18 Connection of FP Series PLC

19 Connection of SLC500 Series PLC

20 Connection of SIMATIC S7 Series PLC

### 11.2.3 Configuration for Q Computer Link Connection (RS-422)

The GOT-F900 and the serial communication unit can be connected on the "1:1" basis. By connecting the GOT-F900 to a serial communication unit attached to the Q Series PLC, two or more GOT units can be connected.

#### 1) F920GOT-K (24V type)/F930GOT/F930GOT-K/F940GOT/F940WGOT

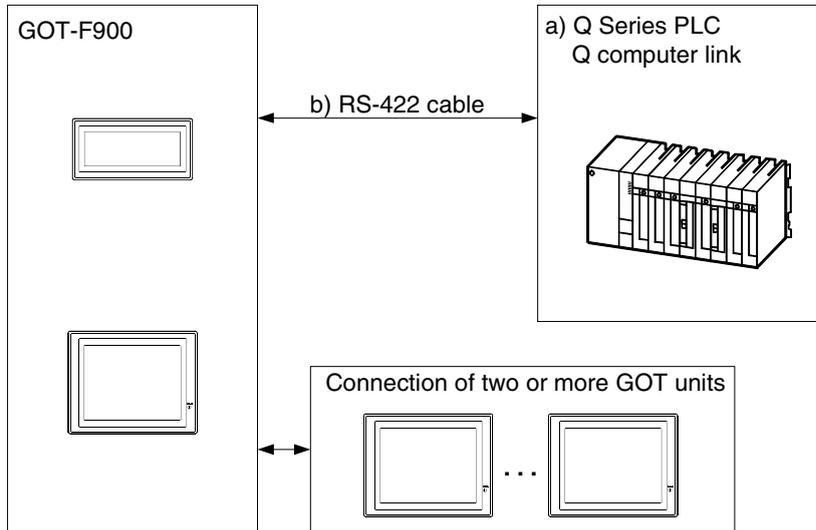

a) Q Series PLC		b) RS-422 cable	Remarks
QJ71C24(N)	Two-piece terminal block (CH2)	Prepared by the user.	Make sure the total cable extension distance is 30m (98' 5") or less.

- Applicable Q Series PLC products in the column a) are computer link units equipped with built-in RS-422 interface.
- Connect the terminating resistor on the serial communication unit.

2) F940 Handy GOT

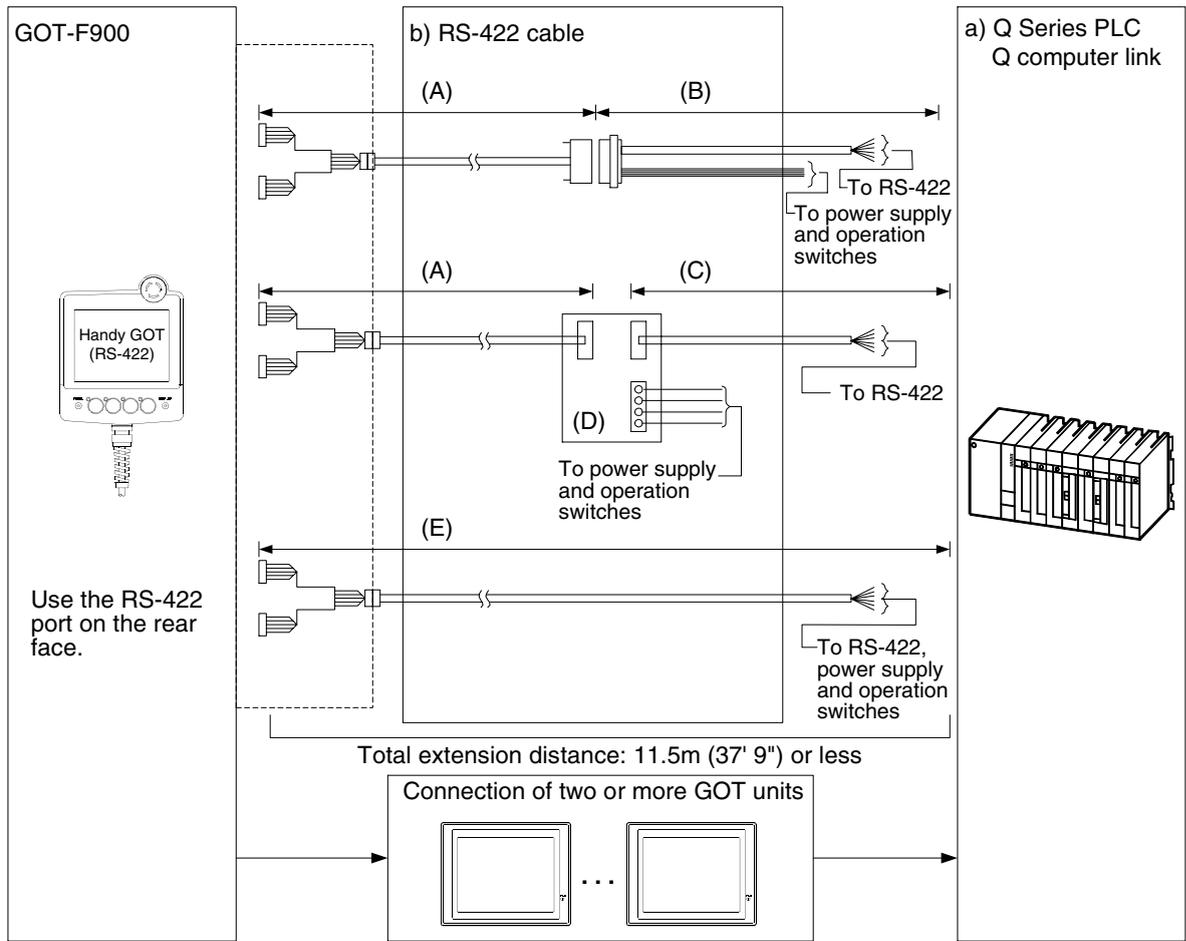

a) Q Series PLC		b) RS-422 cable	Remarks
QJ71C24(N)	Two-piece terminal block (CH2)	(A) F9GT-HCAB-□□M (B) Prepared by the user. (C) Prepared by the user. (D) F9GT-HCNB (E) F9GT-HCAB1-□□M	-

- Applicable Q Series PLC products in the column a) are computer link units equipped with built-in RS-422 interface.
- Make sure that the total cable extension distance "(A) + (B)" or (E) is 11.5m (37' 9") or less.
- Connect the terminating resistor on the serial communication unit.

11 Connection of MELSEC-Q Series PLC

12 Connection of FX Series Positioning

13 Connection of FREQROL Inverter

14 Connection of Micro-computer

15 Connection of SYSMAC C Series PLC

16 Connection of FLEX-PC N Series PLC

17 Connection of Machine Controller

18 Connection of FP Series PLC

19 Connection of SLC500 Series PLC

20 Connection of SIMATIC S7 Series PLC

### 11.2.4 Configuration for Q Computer Link Connection (RS-232C)

The GOT-F900 and the serial communication unit can be connected on the "1:1" basis. By connecting the GOT-F900 to a serial communication unit attached to the Q Series PLC, two or more GOT units can be connected.

#### 1) F920GOT-K (24V type)/F930GOT/F930GOT-K/F940GOT/F940WGOT

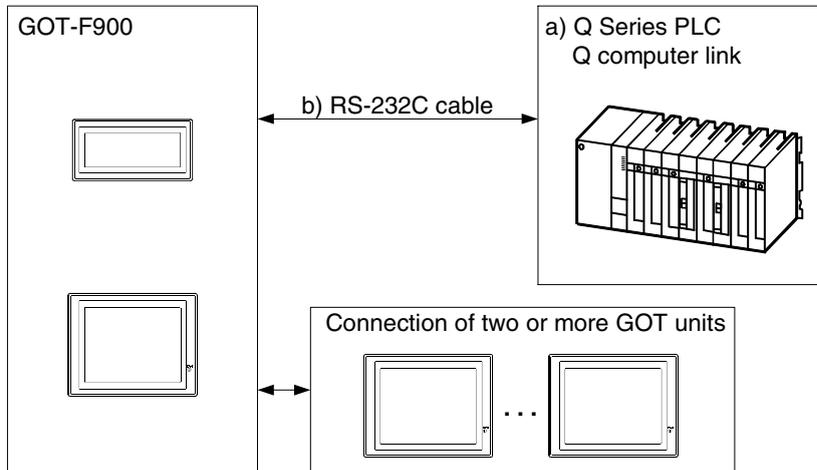

a) Q Series PLC		b) RS-232C cable	Remarks
AJ71QC24(N)	9-pin D-Sub (CH1)	Prepared by the user.	Make sure the total cable extension distance is 15m (49' 3") or less.
AJ71QC24-R2	9-pin D-Sub (CH1 or CH2)	Prepared by the user.	Make sure the total cable extension distance is 15m (49' 3") or less.

- Applicable Q Series PLC products in the column a) are computer link units equipped with built-in RS-232C interface.

2) F943 Handy GOT

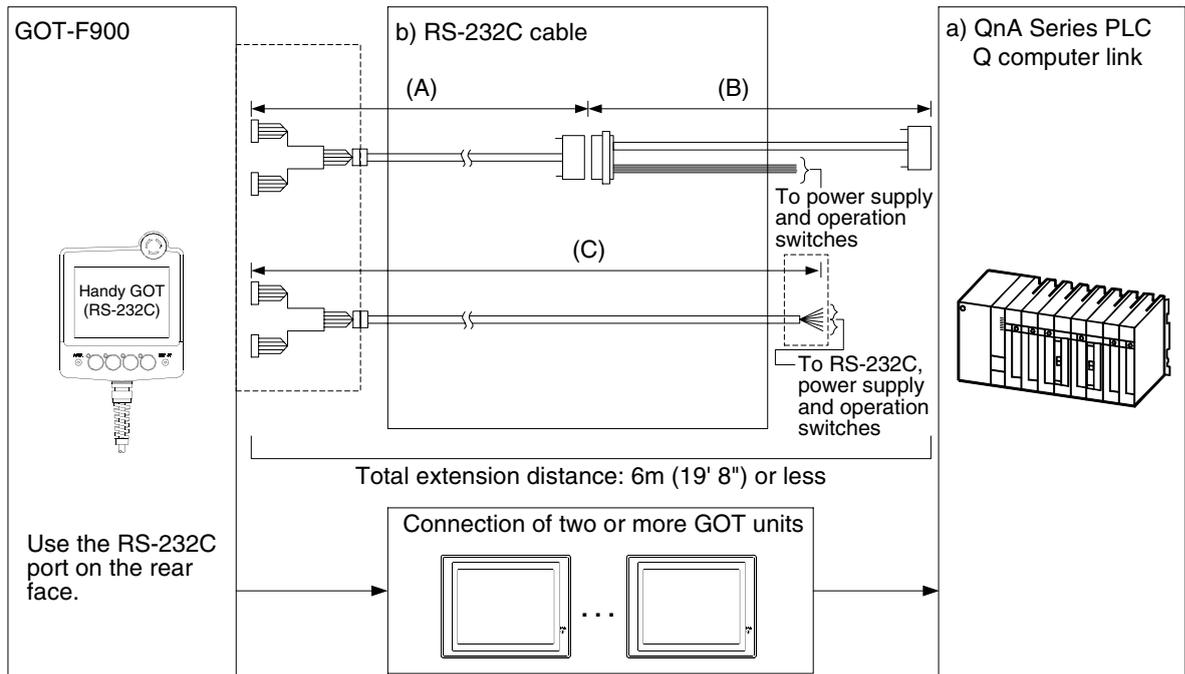

a) Q Series PLC		b) RS-232C cable	Remarks
QJ71C24(N)	9-pin D-Sub (CH1)	(A) F9GT-HCAB-3M (B) Prepared by the user.	-
QJ71C24-R2	9-pin D-Sub (CH1 or CH2)	(C) F9GT-HCAB1-3M	-

- In the (C)F9GT-HCAB1-3M shown in the column "b) RS-232C cable", the end on the PLC side is loose wires.
- Make sure that the total cable extension distance "(A) + (B)" or (C) is 6 m or less.

### 11.3 Setting in Q Serial Communication Unit

In Q computer link connection, the switches in the serial communication unit should be set as described below. When setting the switches for communication with the GOT-F900, use the GX Developer (as described in the next page).

#### 11.3.1 Communication Setting Specifications

This section explains the communication specifications.

##### 1) Setting the communication protocol

Set the communication protocol so that the COM port of the serial communication unit connected to the GOT-F900 is set to the dedicated (MC) protocol format 5.

Serial communication unit	COM port	Switch	Set value	Remarks
QJ71C24(N)	CH1(RS-232C)	Switch 2	5H	For communication using binary codes of QnA compatible 4C frame
	CH2(RS-422)	Switch 4		
QJ71C24-R2	CH1(RS-232C)	Switch 2		
	CH2(RS-232C)	Switch 4		

##### 2) Setting the transmission specifications setting switches

Set the transmission specifications setting switches of the serial communication unit to realize the transmission specifications shown in the table below.

For the switch setting method, refer to the manual of the serial communication unit.

Item	Specifications	Set value	Switch	
			CH1	CH2
Transmission speed	38400 bps	09H	(CH1 side: Switch 1 (upper))	(CH2 side: Switch 3 (upper))
Data format	Data bit	8 bits	(CH1 side: Switch 1 (lower))	(CH2 side: Switch 3 (lower))
	Parity bit	Provided (odd)		
	Stop bit	1 bit		
	Sum check	Provided		
Write in RUN mode	Possible			

- The specifications such as the transmission speed are fixed on the GOT-F900 side, and cannot be changed.

b7 b6 b5 b4 b3 b2 b1 b0

--	--	--	--	--	--	--	--

CH1 side: Switch 1 (lower)  
CH2 side: Switch 3 (lower)

Bit	Description	OFF (0)	OFF (1)	Remarks
b0	Operation setting	Independent	Interlocking	Make sure to set the CH1 side to OFF.
b1	Data bit	7	8	The parity bit is excluded.
b2	Parity bit	Not provided	Provided	Vertical parity
b3	Odd/even parity	Odd	Even	Valid only when the parity bit is set to "odd" or "even".
b4	Stop bit	1	2	-
b5	Sum check code	Odd	Provided	-
b6	Write in RUN mode	Forbidden	Permitted	-
b7	Setting change	Forbidden	Permitted	-

##### 3) Setting the station number setting switch

Set to 00H in both the GOT-F900 and the serial communication unit (switch 5).

##### 4) Turning on the power again

After setting the QnA computer link, make sure to turn off the power once, then turn it on again. (Even if the RESET switch in the QnA Series PLC is pressed, the changed setting does not become valid.)

### 11.3.2 Setting by GPPW

Set the switches in the QJ71C24(-R2) using "I/O assignment" of the GX Developer.  
For details of the setting, refer to the GX Developer OPERATING MANUAL.

#### 1) I/O assignment

Set the type of the unit attached on the base unit and the switches in the QJ71C24(-R2).

**[Open procedure]**

"GX Developer" → "PLC Parameter" → "I/O assignment"

**[Display contents]**

- a) Type  
Set "Intelli".
- b) Model name  
Set the model name of the attached unit (QJ71C24(N) or QJ71C24-R2).
- c) Points  
Set "32".
- d) Start XY  
Set the head I/O signal number (hexadecimal) of the target unit.

#### 2) Switch setting for the I/O unit/intelligent function unit

Set the transmission specifications, the communication protocol, etc. between the GOT and connected equipment.

**[Open procedure]**

"GX Developer" → "PLC Parameter" → "I/O assignment" → "Switch setting"

The contents of setting vary depending on the CH (interface number) of the serial communication unit connected to the GOT.

Set the following in accordance with the connected CH.

CH connected to GOT	Contents of setting																																								
CH1	<table border="1"> <thead> <tr> <th>Slot</th> <th>Type</th> <th>Model name</th> <th>Switch 1</th> <th>Switch 2</th> <th>Switch 3</th> <th>Switch 4</th> <th>Switch 5</th> </tr> </thead> <tbody> <tr> <td>0</td> <td>PLC</td> <td></td> <td></td> <td></td> <td></td> <td></td> <td></td> </tr> <tr> <td>1</td> <td>0(*-0)</td> <td>Intelli</td> <td>QJ71C24(-R2)</td> <td>0966</td> <td>0005</td> <td></td> <td>0000</td> </tr> <tr> <td>2</td> <td>1(*-1)</td> <td></td> <td></td> <td></td> <td></td> <td></td> <td></td> </tr> <tr> <td>3</td> <td>2(*-2)</td> <td></td> <td></td> <td></td> <td></td> <td></td> <td></td> </tr> </tbody> </table>	Slot	Type	Model name	Switch 1	Switch 2	Switch 3	Switch 4	Switch 5	0	PLC							1	0(*-0)	Intelli	QJ71C24(-R2)	0966	0005		0000	2	1(*-1)							3	2(*-2)						
Slot	Type	Model name	Switch 1	Switch 2	Switch 3	Switch 4	Switch 5																																		
0	PLC																																								
1	0(*-0)	Intelli	QJ71C24(-R2)	0966	0005		0000																																		
2	1(*-1)																																								
3	2(*-2)																																								
CH2	<table border="1"> <thead> <tr> <th>Slot</th> <th>Type</th> <th>Model name</th> <th>Switch 1</th> <th>Switch 2</th> <th>Switch 3</th> <th>Switch 4</th> <th>Switch 5</th> </tr> </thead> <tbody> <tr> <td>0</td> <td>PLC</td> <td></td> <td></td> <td></td> <td></td> <td></td> <td></td> </tr> <tr> <td>1</td> <td>0(*-0)</td> <td>Intelli</td> <td>QJ71C24(-R2)</td> <td></td> <td>0966</td> <td>0005</td> <td>0000</td> </tr> <tr> <td>2</td> <td>1(*-1)</td> <td></td> <td></td> <td></td> <td></td> <td></td> <td></td> </tr> <tr> <td>3</td> <td>2(*-2)</td> <td></td> <td></td> <td></td> <td></td> <td></td> <td></td> </tr> </tbody> </table>	Slot	Type	Model name	Switch 1	Switch 2	Switch 3	Switch 4	Switch 5	0	PLC							1	0(*-0)	Intelli	QJ71C24(-R2)		0966	0005	0000	2	1(*-1)							3	2(*-2)						
Slot	Type	Model name	Switch 1	Switch 2	Switch 3	Switch 4	Switch 5																																		
0	PLC																																								
1	0(*-0)	Intelli	QJ71C24(-R2)		0966	0005	0000																																		
2	1(*-1)																																								
3	2(*-2)																																								

### 11.3.3 Used Connectors and Connector Covers

#### 1) Connector on the GOT side

- For the shape of the connector of the GOT (excluding the Handy GOT), refer to chapter 4
- For the shape of the connector of the cable dedicated to the Handy GOT, refer to chapter 5.

#### 2) Connector on the serial communication unit side

The serial communication unit is equipped with the connector having the following model name. Use a suitable counterpart connector.

Manufacturer: DDK Ltd.Japan

17L-10090-27-D9AC



## 11.4 Setting in Q Multi PLC System (Function version -B or later)

QCPU of function version -B or later (except Q00JCPU, Q00CPU, or Q01CPU) is compatible with the multiple PLC system with 4 GOT units maximum.

If the OS version of the GOT-F900 and the screen creation software is compatible with Q multiple PLC system, the screen creation software can specify the monitoring of other GOT through the connected GOT and the CPU.

### 11.4.1 Direct connection to QCPU

The required setting and PLC numbers for connecting the GOT-F900 to the programming port of QCPU (RS-232C) are shown below.

#### 1) GOT-F900 connection

Each QCPU can be connected to the GOT-F900.

Connection of two or more GOT units can be performed and 2-port interface function (Program transfer and monitor using GX Developer) is available.

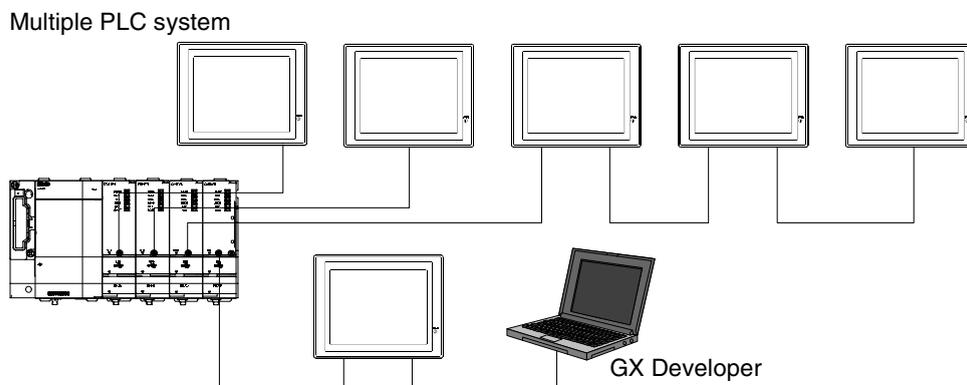

#### 2) Setting in the screen creation software

##### a) GT Designer2

- Select "Common"->"System Environment", then set "PLC Type" to "MELSEC-Q (Multi)".
- Click "Auxiliary Setting" in the "System Environment" tree, then give a check mark (✓) to "Use Serial Port, Setup, Language, Menu Key."
- Click "GOT Setup" in the "System Environment" tree. In "Connection", set "Port" to "RS-422" or "RS-232C", "Type" to "CPU", and "Station No." to "0".

##### b) GT Designer

- Select "Common"->"GOT/PLC Type", then set "PLC Type" to "MELSEC-Q (Multi)".
- Click "Auxiliary Setting"->"Project Unit" in the "Common", then give a check mark (✓) to "Use Serial Port, Setup, Language, Menu Key."
- Click "GOT Setup", then set "Port" to "RS-422" or "RS-232C", "Type" to "CPU", and "Station No." to "0".

##### c) DU/WIN

- The setting is not available.

**3) PLC numbers when appointing device**

PLC numbers from 1 to 4 are allocated (smaller number for the unit closer to the power card).  
Specify the target PLC number and device number when creating screen data.  
When using QCPU with GOT-F900 connected, number 0 (own station) can also be specified.

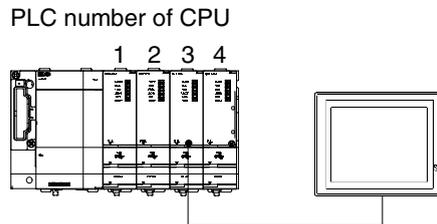

Example:

Specify 1 to monitor the unit with PLC number 1.

Specify 0 or 3 to monitor the unit with PLC number 3.

**11.4.2 Connection to serial communication**

The required setting and PLC numbers for connecting the GOT-F900 to the serial communication unit attached to the Q multiple PLC system are shown below. Note that there are restrictions on use of the serial communication unit not compatible with the multiple PLC system. See below for its setting.

**1) GOT-F900 connection**

GOT-F900 can be connected to RS-232C or RS-422 port on the serial communication unit.

Connection of two or more GOT units can be performed and 2-port interface function (Program transfer and monitor using GX Developer) is available.

**2) Setting in the screen creation software (In the case of the applicable version of Q multi PLC system (Ver. B or later))****a) GT Designer2**

- Select "Common"->"System Environment", then set "PLC Type" to "MELSEC-Q (Multi)".
- Click "Auxiliary Setting" in the "System Environment" tree, then give a check mark (✓) to "Use Serial Port, Setup, Language, Menu Key."
- Click "GOT Setup" in the "System Environment" tree. In "Connection", set "Port" to "RS-422" or "RS-232C", "Type" to "CPU", and "Station No." to "0".

**b) GT Designer**

- Select MELSEC-Q (Multi) in the "GOT/PLC Type" dialog box.
- Click "Auxiliary Setting"->"Project Unit" in the "Common", then give a check mark (✓) to "Use Serial Port, Setup, Language, Menu Key."
- Click "GOT Setup", then set "Port" to "RS-422" or "RS-232C", "Type" to "CPU", and "Station No." to "0".

**c) DU/WIN**

- The setting is not available.

### 3) PLC numbers when appointing device

When the PLC No. is set to "0", the control CPU (No.2 in the example shown below) can be monitored.

If one of the PLC numbers 1 through 4 is specified, the unit with the corresponding PLC number can be monitored.

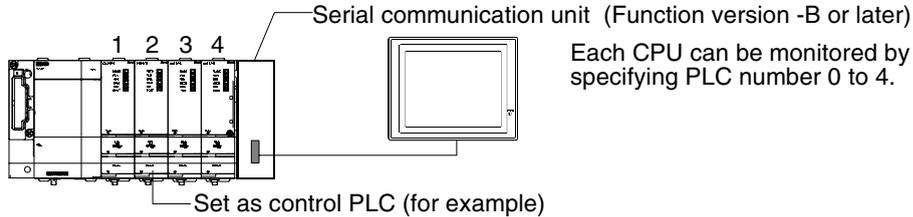

### 4) Serial communication unit not compatible with the Q multiple PLC system (Earlier than Version B)

Version B or later is required for connecting the GOT-F900 to the serial communication unit attached to the Q multiple PLC system (Version B).

### 5) Control PLC

Control PLC is the unit with the number specified under "PLC Parameter" - "I/O assignment" in the GX Developer.

(No setting is available in the version of GX Developer not compatible with multiple PLC system.)

11

Connection of  
MELSEC-Q  
Series PLC

12

Connection of  
FX Series  
Positioning

13

Connection of  
FREQUOL  
Inverter

14

Connection of  
Microcom-  
puter

15

Connection of  
SYSMAC C  
Series PLC

16

Connection of  
FLEX-PC N  
Series PLC

17

Connection of  
Machine Con-  
troller

18

Connection of  
FP Series PLC

19

Connection of  
SLC500  
Series PLC

20

Connection of  
SIMATIC S7  
Series PLC

### 11.5 Caution on Use of MELSEC-Q Series PLC

When using the GOT-F900 connected to the Q Series PLC, observe the following caution on use.

#### 11.5.1 Restriction in device specification

Word specification of bit devices and bit specification of word devices are not supported in the GOT-F900.

#### 11.5.2 Caution when the GOT is connected to the serial communication unit

When the GOT is connected, the CH1 and the CH2 of the serial communication unit cannot be used at the same time.

(The setting "CH1: dedicated protocol format 5, CH2: non-procedural protocol" is available.)

Accordingly, have in mind that connecting both GOT unit and peripheral equipment for the GPP function or two GOT units to one serial communication unit is not allowed.

##### 1) Earlier than Version B

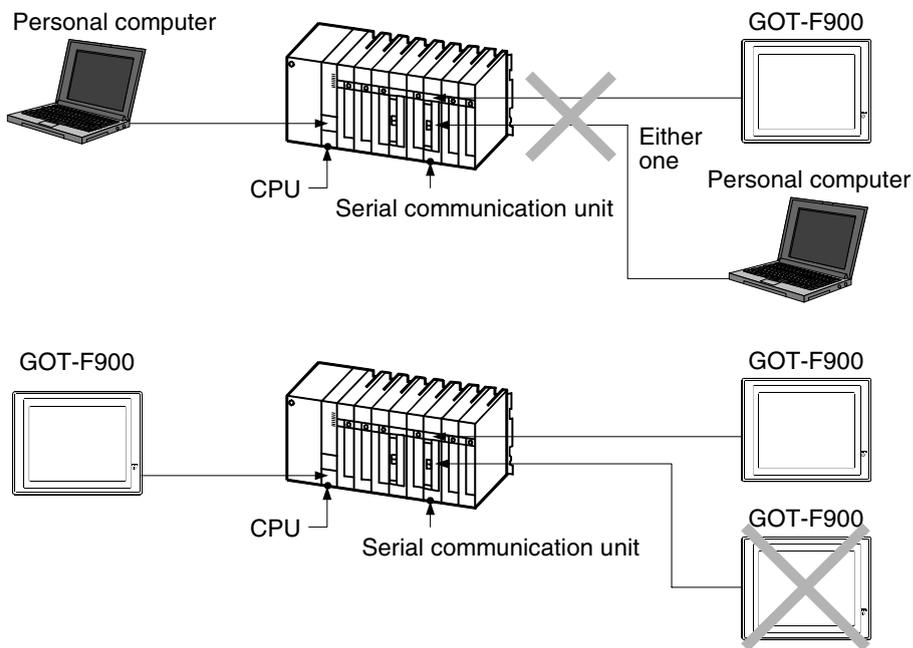

However, a GOT unit (RS-232C) or a personal computer (USB port) can be connected to the QCPU while the computer link unit has one GOT unit.

##### 2) Version B or later

The version B or later of serial communication units can be connected to GOT-F900 at Ch1 and 2 separately.

OS versions compatible with Q series PLC or later are available on the GOT.

**11.5.3 Caution when connecting to Q multiple CPU system**

**1) Restriction in Device Monitor Function of GOT-F900**

The PLC number cannot be specified on the screens for device monitor or sampling in HPP mode on the system screen. Hence, GOT-F900 monitors only the connected CPU.

When a GOT is connected to the serial communication unit, the GOT monitors only the control PLC.

**2) Restriction in Monitored CPU**

The GOT-F900 should be connected only when the system is configured with QCPU. If the system includes a motion control or CPU of personal computer, GOT-F900 should not be connected because monitoring cannot be performed properly even if it is connected to the QCPU.

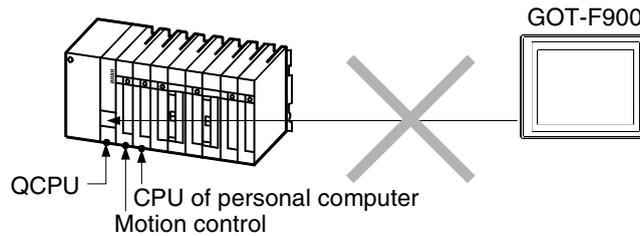

**11.5.4 Caution when setting screen creation software**

QCPU of function version -B or later (except Q00JCPU, Q00CPU, or Q01CPU) is compatible with the multiple PLC system with 4 GOT units maximum.

When two or more QCPU are attached to the main unit, the configuration is called a multiple PLC system, and monitoring of other CPU (number specified) from the CPU connected with the GOT-F900 is enabled.

According to the PLC type specified in the screen creation software, the CPU which can be monitored is determined as follows.

**1) In one unit CPU configuration**

In the screen creation software, select MELSEC-QnA, A for PLC type.

PLC type in screen creation software and GOT	CPU connected with GOT-F900	Other CPU	Serial communication unit
MELSEC-QnA, Q	✓	–	Only control PLC monitored
MELSEC-Q (Multi)	–	–	–

**2) In multiple PLC system**

In the screen creation software, select MELSEC-Q (Multi) for PLC type.

PLC type in screen creation software and GOT	CPU connected with GOT-F900	Other CPU	Serial communication unit
MELSEC-QnA, Q	✓	–	Only control PLC monitored
MELSEC-Q (Multi)	✓	✓	✓

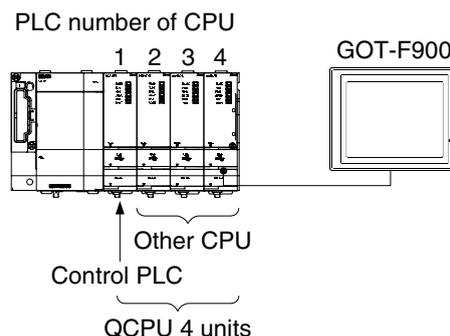

## 11.6 Setting of Connected Equipment for GOT

The setting for connection to the Q Series PLC can be executed using the GOT-F900 and the screen creation software (GT Designer2, GT Designer or DU/WIN).

### Setting the Connection Type

Set the connection type in accordance with the connected equipment as shown in the table below. Have in mind that computer link for Q (serial communication unit) and Q multiple PLC system requires CPU direct connection.

Connected equipment [classification in manual]	GOT-F900	Screen creation software	Remarks
	CONNECTION	Type	
[QCPU direct connection] RS-232C port of QCPU card	CPU direct connection (RS-232C)		Programming port
[Q computer link] QJ71C24(N) (RS-422/RS-232C) QJ71C24-R2 (RS-232C)	CPU direct connection (RS-422) or CPU direct connection (RS-232C)		Communicates as programming port

### 1) GOT-F900 Series

When the main menu screen change operation is disabled.

Operation	Display (screen name)
a) While pressing and holding the upper left corner of the screen, turn on the power. Keep holding the upper left corner for about 25 seconds more. Then, press "END" at the upper right corner. b) Press "PLC TYPE". c) Set the following. PLC TYPE: When monitoring only the connected CPU QnA, Q SERIES When monitoring other CPU via Q multiple PLC system Q (MULTI) SERIES CONNECTION: CPU PORT (RS-422) CPU PORT (RS-232C) DST STATION # (STATION #) : 00 GOT STATION # (-) : -	The "LANGUAGE" screen appears.  The "SET-UP MODE" screen appears. The "PLC TYPE" screen appears.

When the main menu screen change operation is enabled.

Operation	Display (screen name)
a) Press the upper left corner of the screen. (The position to be pressed can be changed in the GOT and the screen creation software.) b) Press "OTHER MODE" on the menu. c) Press "SET-UP MODE" on the menu. d) Press "PLC TYPE". e) Set the following. PLC TYPE: When monitoring only the connected CPU QnA, Q SERIES When monitoring other CPU via Q multiple PLC system Q (MULTI) SERIES CONNECTION: CPU PORT (RS-422) CPU PORT (RS-232C) DST STATION # (STATION #) : 00 GOT STATION # (-) : -	The "SELECT MODE" screen appears.  The "OTHER MODE" screen appears. The "SET-UP MODE" screen appears. The "PLC TYPE" screen appears.

- When the screen data is transferred to the GOT-F900, the old data including the PLC type, connection type, and station number are overwritten.
- The "PLC type" selection item display varies depending on the OS version as follows.

GOT-F900		"PLC TYPE" selection item display in GOT			
		A SERIES	A, QnA SERIES	A SERIES *1 QnA, Q SERIES	A SERIES QnA, Q SERIES Q (Multi) SERIES
OS version	F940WGOT	-	-	1.00 or later	1.30 or later
	F940GOT, Handy GOT	1.00 or later	3.00 or later	4.10 or later	6.30 or later
	F930GOT-K	-	-	4.60 or later	4.60 or later
	F930GOT	1.00 or later	2.00 or later	2.20 or later	4.30 or later
	F920GOT-K	-	-	1.00 or later	1.00 or later
Connection setting availability		Not available	Not available	Available (Select "QnA, Q SERIES".)	Available (Select "QnA, Q SERIES" or "Q (MULTI) SERIES".)

\*1 Available choices on the menu are changed to "A SERIES" and "QnA, Q SERIES".

2) GT Designer2

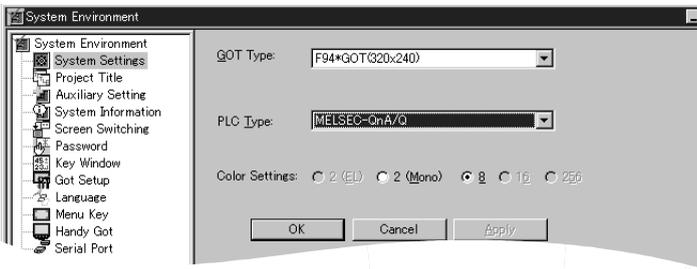
Operation	Display (screen name)										
<p>[Creation]</p> <p>a) Open GT Designer2.</p> <p>b) Click the [NEW] button. The dialog box shown below is displayed. If it is not displayed, click "System Environment" in the tree displayed in the project work space, then click "System settings" in the tree.</p>  <p>c) Set the following. GOT type: F940WGOT (480 × 234) F94*GOT (320 × 240) F93*GOT (240 × 80) F920GOT (128 × 64) PLC type: When monitoring only the connected CPU: MELSEC-QnA, Q When monitoring other CPU connected using Q Multi system: MELSEC-Q (Multi) Selection of "GOT type"</p> <table border="1" data-bbox="483 1749 1114 2011"> <thead> <tr> <th>GOT type</th> <th>Model name (name)</th> </tr> </thead> <tbody> <tr> <td>F940WGOT(480×234)&lt;WIDE&gt;</td> <td>F940WGOT</td> </tr> <tr> <td>F94*GOT(320×240)</td> <td>F940GOT Handy GOT</td> </tr> <tr> <td>F930GOT(240×80)</td> <td>F930GOT F930GOT-K</td> </tr> <tr> <td>F920GOT(128×64)</td> <td>F920GOT-K</td> </tr> </tbody> </table> <p>Click [OK].</p>	GOT type	Model name (name)	F940WGOT(480×234)<WIDE>	F940WGOT	F94*GOT(320×240)	F940GOT Handy GOT	F930GOT(240×80)	F930GOT F930GOT-K	F920GOT(128×64)	F920GOT-K	<p>The "Select Project" dialog box appears.</p> <p>The "System Environment" dialog box appears.</p>
GOT type	Model name (name)										
F940WGOT(480×234)<WIDE>	F940WGOT										
F94*GOT(320×240)	F940GOT Handy GOT										
F930GOT(240×80)	F930GOT F930GOT-K										
F920GOT(128×64)	F920GOT-K										



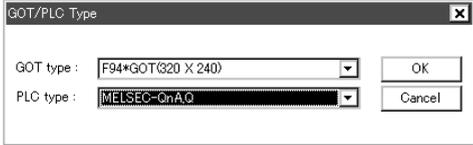
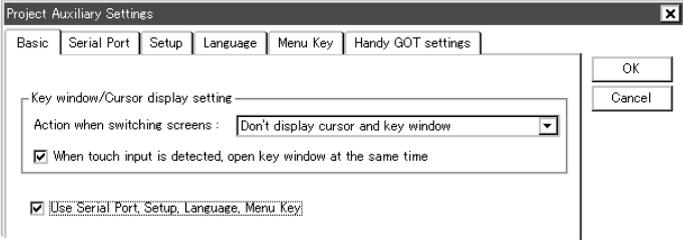
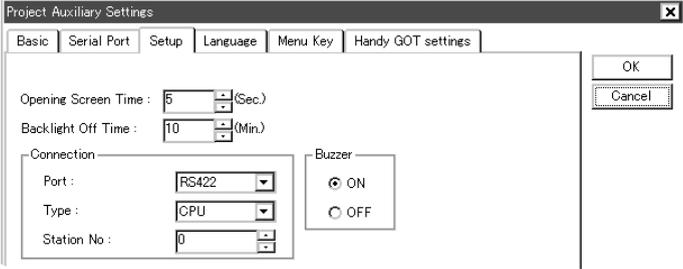

3) GT Designer

Operation	Display (screen name)										
<p>[Creation]</p> <p>a) Open GT Designer.</p> <p>b) Click the [New] button.</p>  <p>c) Set the following.</p> <p>GOT type: F940WGOT (480 × 234) &lt;WIDE&gt;            F94*GOT (320 × 240)            F93*GOT (240 × 80)            F920GOT (128 × 64)</p> <p>PLC type: When monitoring only the connected CPU:            MELSEC-QnA, Q            When monitoring other CPU connected using Q Multi system:            MELSEC-Q (Multi)</p> <p>Selection of "GOT type"</p> <table border="1" data-bbox="496 936 1106 1196"> <thead> <tr> <th>GOT type</th> <th>Model name</th> </tr> </thead> <tbody> <tr> <td>F940WGOT(480×234)&lt;WIDE&gt;</td> <td>F940WGOT</td> </tr> <tr> <td>F94*GOT(320×240)</td> <td>F940GOT Handy GOT</td> </tr> <tr> <td>F93*GOT(240×80)</td> <td>F930GOT-K F930GOT</td> </tr> <tr> <td>F920GOT(128×64)</td> <td>F920GOT-K</td> </tr> </tbody> </table> <p>Click [OK].</p> <p>d) Set CPU direct connection (RS-422/RS-232C) of the GOT-F900. This setting is enabled in the SW4D5C-GOTR-PACKE version A or later.</p> <p>Click the check box of "Use Serial Port, Setup, Language, Menu Key" to give a check mark (✓).</p>  <p>Click the "Setup" tab.</p> 	GOT type	Model name	F940WGOT(480×234)<WIDE>	F940WGOT	F94*GOT(320×240)	F940GOT Handy GOT	F93*GOT(240×80)	F930GOT-K F930GOT	F920GOT(128×64)	F920GOT-K	<p>The "Select Project" dialog box appears.</p> <p>The "GOT/PLC Type" dialog box appears.</p> <p>The "Project Auxiliary Settings" dialog box appears.</p>
GOT type	Model name										
F940WGOT(480×234)<WIDE>	F940WGOT										
F94*GOT(320×240)	F940GOT Handy GOT										
F93*GOT(240×80)	F930GOT-K F930GOT										
F920GOT(128×64)	F920GOT-K										

Operation		Display (screen name)									
	<p>In the case of SW4D5C-GOTR-PACKE earlier than version A, perform the setting in the GOT-F900. (Set the connection in "CONNECTION" in the GOT-F900.) For the setting method, refer to "1) GOT-F900 Series" on the previous page.</p> <p>e) Set the following.                      Port : RS-422                      RS-232C                      Type : CPU                      DST Station No. (Station No.) : 0                      GOT Station No. (-) : -</p> <p><u>In the case of F943 Handy GOT</u>                      Without regard to the port setting (RS-422 or RS-232C), the COM0 side of the RS-232C is fixed for PLC connection.</p> <p>Combinations of "Port" and "Type" are as follows.</p> <table border="1"> <thead> <tr> <th>Connection destination</th> <th>Port</th> <th>Type</th> </tr> </thead> <tbody> <tr> <td>Direct connection to Q CPU</td> <td rowspan="2">RS-232C</td> <td rowspan="3">CPU</td> </tr> <tr> <td>Computer link unit for Q</td> </tr> <tr> <td>Computer link unit for Q</td> <td>RS-422</td> </tr> </tbody> </table>	Connection destination	Port	Type	Direct connection to Q CPU	RS-232C	CPU	Computer link unit for Q	Computer link unit for Q	RS-422	
Connection destination	Port	Type									
Direct connection to Q CPU	RS-232C	CPU									
Computer link unit for Q											
Computer link unit for Q	RS-422										
[Change method]	<p>Change the connection type of the already created data as follows.</p> <p>a) Open GT Designer.                      b) Click the [Open] button.                      c) Open (read) the screen data to be changed.                      d) On the menu, select "Common"-&gt;"GOT/PLC Type".                      - For the contents of setting, refer to c) of [Creation] above.                      - For selection of the RS-422 or the RS-232C on the Q Series PLCs, refer to e) of [Creation] above.</p>	<p>The "Select Project" dialog box appears.</p> <p>The "GOT/PLC Type" dialog box appears.</p>									

- The "PLC type" selection item display varies depending on the software version as follows.

GT Designer	"PLC type" selection item display in GT Designer			
	MELSEC-A	MELSEC-A, QnA	MELSEC-A *1 MELSEC-QnA, Q	MELSEC-A MELSEC-QnA, Q MELSEC-Q (Multi)
Version	SW1-A or later	SW2-A or later	SW4-F or later	SW5-P or later (5.13P)
Connection setting availability	Not available	Not available	Available (Select "MELSEC-QnA,Q".)	Available (Select "QnA, Q SERIES" or "Q (MULTI) SERIES".)

\*1 Available choices on the menu are changed to "A SERIES" and "QnA, Q SERIES".

4) DU/WIN

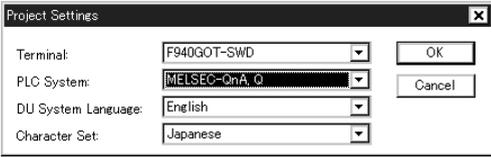
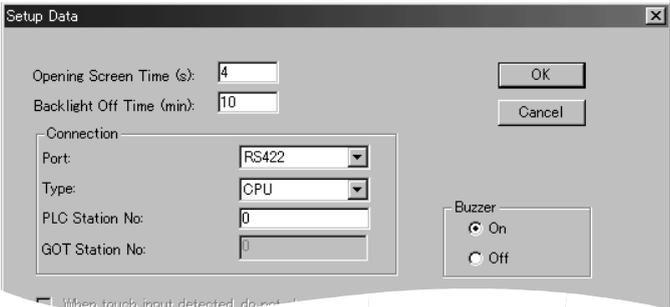
	Operation	Display (screen name)												
[Creation]	<p>a) Open DU/WIN.</p> <p>b) On the menu, select "File"-"New".</p>  <p>c) Set the following.</p> <p>Terminal: F940WGOT-TWD (V)(H)                      F940GOT-LWD                      F940GOT-SWD                      F930GOT-BWD (V)(H)                      F920GOT-BBD5-K</p> <p>PLC System: When monitoring only the connected CPU:                      MELSEC-QnA, Q                      When monitoring other CPU connected using the Q                      Multi system:                      Not available</p> <p>Select "Terminal" in accordance with the LC display color.</p> <table border="1" data-bbox="464 965 1134 1294"> <thead> <tr> <th>Terminal</th> <th>Model name</th> </tr> </thead> <tbody> <tr> <td>F940WGOT-TWD (V)(H)</td> <td>F940WGOT (color)</td> </tr> <tr> <td>F940GOT-LWD</td> <td>F940GOT (black and white) Handy GOT (black and white)</td> </tr> <tr> <td>F940GOT-SWD</td> <td>F940GOT (color) Handy GOT (color)</td> </tr> <tr> <td>F930GOT-BWD (V)(H)</td> <td>F930GOT-K (blue) F930GOT (blue)</td> </tr> <tr> <td>F920GOT-BBD5-K</td> <td>F920GOT-K (blue)</td> </tr> </tbody> </table> <p>d) Set CPU direct connection (RS-422/RS-232C) of the GOT-F900. On the menu, select "View/Project"-"System Settings"-"Setup Data".</p> 	Terminal	Model name	F940WGOT-TWD (V)(H)	F940WGOT (color)	F940GOT-LWD	F940GOT (black and white) Handy GOT (black and white)	F940GOT-SWD	F940GOT (color) Handy GOT (color)	F930GOT-BWD (V)(H)	F930GOT-K (blue) F930GOT (blue)	F920GOT-BBD5-K	F920GOT-K (blue)	<p>The "Project settings" dialog box appears.</p> <p>The "Setup Data" dialog box appears.</p>
Terminal	Model name													
F940WGOT-TWD (V)(H)	F940WGOT (color)													
F940GOT-LWD	F940GOT (black and white) Handy GOT (black and white)													
F940GOT-SWD	F940GOT (color) Handy GOT (color)													
F930GOT-BWD (V)(H)	F930GOT-K (blue) F930GOT (blue)													
F920GOT-BBD5-K	F920GOT-K (blue)													

11 Connection of MELSEC-Q Series PLC

12 Connection of FX Series Positioning

13 Connection of FREQROL Inverter

14 Connection of Microcomputer

15 Connection of SYSMAC C Series PLC

16 Connection of FLEX-PC N Series PLC

17 Connection of Machine Controller

18 Connection of FP Series PLC

19 Connection of SLC500 Series PLC

20 Connection of SIMATIC S7 Series PLC

Operation		Display (screen name)									
	<p>e)Set the following.                      Port: RS-422                      RS-232C                      Type: CPU                      DST Station No. (Station No.): 0                      GOT Station No. (-) : -  <u>In the case of F943 Handy GOT</u>                      Without regard to the port setting (RS-422 or RS-232C), the COM0 side of the RS-232C is fixed for PLC connection.                      Combinations of "Port" and "Type" are as follows.</p> <table border="1"> <thead> <tr> <th>Connection destination</th> <th>Port</th> <th>Type</th> </tr> </thead> <tbody> <tr> <td>Direct connection to Q CPU</td> <td rowspan="2">RS-422</td> <td rowspan="3">CPU</td> </tr> <tr> <td>Computer link unit for Q</td> </tr> <tr> <td>Computer link unit for Q</td> <td>RS-232C</td> </tr> </tbody> </table>	Connection destination	Port	Type	Direct connection to Q CPU	RS-422	CPU	Computer link unit for Q	Computer link unit for Q	RS-232C	
Connection destination	Port	Type									
Direct connection to Q CPU	RS-422	CPU									
Computer link unit for Q											
Computer link unit for Q	RS-232C										
[Change method]	<p>Change the connection type of the already created data as follows.                      a)Open DU/WIN.                      b)On the menu, select "File"-"Open".                      c)Select and open (read) the file of the screen data to be changed.                      d)When changing "Terminal" (GOT-F900), select "View/Project"-"System Settings"-"Project settings" on the menu.                      - For the contents of setting, refer to c) of [Creation] above.</p>	<p>The "Open" dialog box appears.                      The "Project settings" dialog box appears.</p>									

- The "PLC" selection item display varies depending on the software version as follows.

DU/WIN	"PLC System" selection item display in DU/WIN		
	MELSEC-A	MELSEC-A, QnA	MELSEC-A *1 MELSEC-QnA, Q
Version	2.00 or later	2.30 or later	2.40 or later
Connection setting availability	Not available	Not available	Available(Select "MELSEC-QnA, Q".)

\*1 Note that the selection item display is changed from "MELSEC-A, QnA" to "MELSEC-A" and "MELSEC-QnA, Q".

## 11.7 Cable Diagram

This section explains cable diagrams to connect the GOT-F900 and the Q Series PLC.

### 11.7.1 Cautions on preparing cables

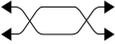
- 1) When preparing the cables, use the wire size of 0.08mm<sup>2</sup> or more (AWG28 or more) for communication, 0.3mm<sup>2</sup> or more (AWG22 or more) for the power supply, operation switch, and emergency stop switch.
- 2)  stands for a twisted pair cable. Prepare a twisted pair cable in combination of the pin numbers and signal lines described on the cable diagram.  
Do not use a twisted pair cable with the power supply wire and the communication wire.

### 11.7.2 Cable diagram

#### 1) Cable for the GOT and the Q Series PLC

F920GOT-K (5V type)

When connecting the F920GOT-K directly to the Q Series PLC, the below cable is required to transfer screen data.

For caution on use, refer to section 6.4.

#### Composition of Q Series PLC connection

When connecting GOT-F900 to the Q series PLC directly, connects by the following cable.

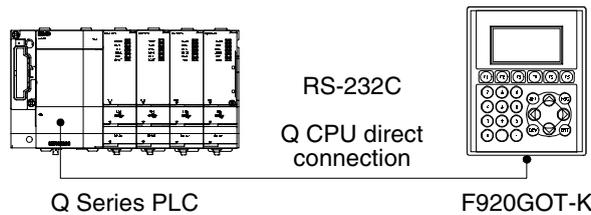

 : Female type  : Male type The connector figure shows the engagement face.

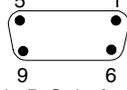
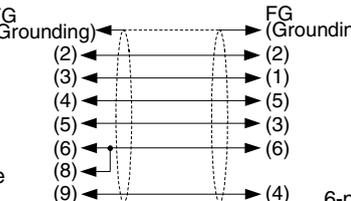
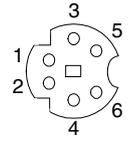
No.	Model name	Application	Connection diagram	Application
a)	<p><b>Q CPU direct connection</b></p> <p><b>RS-232C connection</b></p> <p>Prepared by the user. (Cable length 3m (9'10") or less)</p> <p>Resistance per wire: 0.67 Ω or less (Approximately AWG 28 or thicker)</p>	<p>To GOT-F900</p>  <p>9-pin D-Sub, female</p>		<p>To Q Series</p>  <p>6-pin MINI DIN, male</p>

Composition for translating screen data to GOT

When downloading/uploading the screen data to/from the F920GOT-K(5V type), the following power cable is necessary for supplying 5V DC from the Q series PLC.

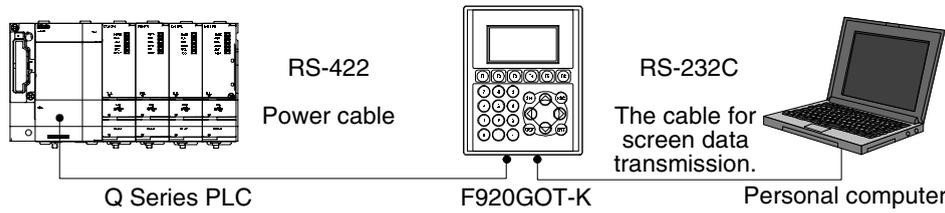

: Female type : Male type The connector figure shows the engagement face.

No.	Model name	Application	Connection diagram	Application
b)	<p><b>GOT power cable</b> Prepared by the user. (Cable length 3m (9'10") or less) Resistance per wire: 0.67 Ω or less (Approximately AWG 28 or thicker)</p>	<p>To F920GOT-K</p> <p>9-pin D-Sub, male</p>		<p>To Q Series</p> <p>6-pin MINI DIN, male</p>

F920GOT-K (24V type)/F930GOT/F930GOT-K/F940GOT/F940WGOT

: Female type : Male type The connector figure shows the engagement face.

No.	Model name	Application	Connection diagram	Application
a)	<p><b>Q CPU direct connection</b> QC30R2</p>	<p>To GOT-F900</p> <p>9-pin D-Sub, female</p>		<p>To Q Series</p> <p>6-pin MINI DIN, male</p>
b)	<p><b>Q computer link</b> Connect to the terminating resistor on the computer link unit side. For details, refer to the User's manual of the computer link unit.</p>	<p>To GOT-F900</p> <p>9-pin D-Sub, male</p>	<p>Signal name of computer link</p>	<p>To serial communication unit side (PLC side)</p> <p>Terminal communication block</p>
c)	<p><b>Q computer link</b> Prepared by the user.</p>	<p>To GOT-F900</p> <p>9-pin D-Sub, female</p>	<p>Signal name of computer link</p>	<p>To serial communication unit side (PLC side)</p> <p>9-pin D-Sub, male</p>

2) Cable for the Handy GOT and the Q Series PLC

When using the Handy GOT RH model, refer to the cable diagrams below for the RS-422/RS-232C connector, but not the wiring for the power supply, the operation switches, and the emergency stop switch because it is different. For details, refer to Section 5.18.

 : Female type  : Male type The connector figure shows the engagement face.

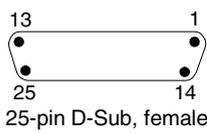
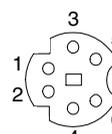
No.	Model name	Application	Connection diagram	Application
a)	F9GT-HCAB-3M F9GT-HCAB-10M	Dedicated connector	<div style="display: flex; justify-content: space-around;"> <div style="border: 1px solid black; padding: 2px;">RS-422 connection</div> <div style="border: 1px solid black; padding: 2px;">RS-232C connection</div> </div> <p>The connector on the leader side of the Handy GOT is dedicated, and cannot be prepared by the user.</p>	To F9GT-HCAB3-150  25-pin D-Sub, male
b)	F9GT-HCAB1-3M F9GT-HCAB1-10M	Dedicated connector	<div style="display: flex; justify-content: space-around;"> <div style="border: 1px solid black; padding: 2px;">RS-422 connection</div> <div style="border: 1px solid black; padding: 2px;">RS-232C connection</div> </div> <p>The connector on the leader side of the Handy GOT is dedicated, and cannot be prepared by the user.</p>	Loose wires (no connector)
c)	F9GT-HCAB5-150	RS-232C connection	<p>Wiring according to the pin number of F9GT-HCAB-□□□M</p> <div style="display: flex; justify-content: space-between;"> <div style="width: 30%;"> <p>To F9GT-HCAB</p>  <p>25-pin D-Sub, female</p> </div> <div style="width: 40%; border: 1px dashed black; padding: 5px;"> <p>Drain wire (1) → FG (Grounding)</p> <p>BK (2) → (1)</p> <p>W (3) → (5)</p> <p>GR (5) → (6)</p> <p>BR (7) → (2)</p> <p>R (4) → (3)</p> <p>O (10) → (3)</p> <p>SHELL</p> <p>PL (12) → DC24VG</p> <p>PK (13) → DC24VG</p> <p>LTGR (14) → SW-COM / ES1-2</p> <p>SB (15) → SW1 / DSW2</p> <p>BK/W (16) → SW2 / DSW2</p> <p>R/W (17) → SW3 / DSW1</p> <p>GR/W (18) → SW4 / DSW1</p> <p>O/W (20) → / ES1-2</p> <p>Y/W (21) → ES1 / ES1-1</p> <p>BR/W (22) → ES1 / ES1-1</p> <p>BL/W (24) → DC24V+</p> <p>GY/W (25) → DC24V+</p> </div> <div style="width: 25%;"> <p>To Q Series</p>  <p>6-pin MINI DIN, male</p> </div> </div> <p>Wire the power supply, the operation switches and the emergency stop switch.</p> <p>← Old cable description → New cable description</p>	
d)	<p><u>Q computer link</u> Prepared by the user</p> <p>Connect to the terminating resistor on the computer link unit side. For details, refer to the User's manual of the computer link unit.</p>	Terminal block	<p>Wiring according to the pin number of F9GT-HCAB-□□□M</p> <div style="display: flex; justify-content: space-between;"> <div style="width: 30%;"> <p>Drain wire (1) → FG (Grounding)</p> <p>BK (2) → RXD+(RDA)</p> <p>W (3) → RXD-(RDB)</p> <p>Y (6) → TXD+(SDA)</p> <p>BR (7) → TXD-(SDB)</p> <p>O (10) → SG (GND)</p> <p>Signal name of computer link</p> <p>PL (12) → DC24VG</p> <p>PK (13) → DC24VG</p> <p>LTGR (14) → SW-COM / ES1-2</p> <p>SB (15) → SW1 / DSW2</p> <p>BK/W (16) → SW2 / DSW2</p> <p>R/W (17) → SW3 / DSW1</p> <p>GR/W (18) → SW4 / DSW1</p> <p>O/W (20) → / ES1-2</p> <p>Y/W (21) → ES1 / ES1-1</p> <p>BR/W (22) → ES1 / ES1-1</p> <p>BL/W (24) → DC24V+</p> <p>GY/W (25) → DC24V+</p> </div> <div style="width: 40%; border: 1px dashed black; padding: 5px;"> <p>Terminal block</p> <p>To computer link unit side (PLC side)</p> </div> </div> <p>Wire the power supply, the operation switches and the emergency stop switch.</p> <p>← Old cable description → New cable description</p>	

11	Connection of MELSEC-Q Series PLC
12	Connection of FX Series Positioning
13	Connection of FREQROL Inverter
14	Connection of Microcomputer
15	Connection of SYSMAC Series PLC
16	Connection of FLEX-PC N Series PLC
17	Connection of Machine Controller
18	Connection of FP Series PLC
19	Connection of SLC500 Series PLC
20	Connection of SIMATIC S7 Series PLC

 : Female type  : Male type The connector figure shows the engagement face.

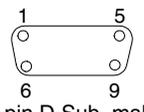
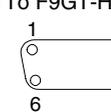
No.	Model name	Application	Connection diagram	Application
e)	Prepared by the user	<p><b>RS-232C connection</b></p> <p>To cable F9GT-HCAB or F9GT-HCAB1 on Handy GOT side</p> <p>Drain wire (1) R (4) BK (2) W (3) O (10) GR (5) Y (6) BR (7)</p>	<p>Wiring according to the pin number of F9GT-HCAB-□□M</p> <p>FG (Grounding)</p> <p>(1) CD (DCD) (2) RD (RXD) (3) SD (TXD) (4) DR (DTR) (5) SG (GND) (6) DR (DSR) (7) RS (RTS) (8) CS (CTS)</p> <p>Signal name of computer link</p> <p>PL (12) ←→ DC24VG PK (13) ←→ DC24VG LTGR (14) ←→ SW-COM / ES1-2 SB (15) ←→ SW1 / DSW2 BK/W (16) ←→ SW2 / DSW2 R/W (17) ←→ SW3 / DSW1 GR/W (18) ←→ SW4 / DSW1 O/W (20) ←→ / ES1-2 Y/W (21) ←→ ES1 / ES1-1 BR/W (22) ←→ ES1 / ES1-1 BL/W (24) ←→ DC24V+ GY/W (25) ←→ DC24V+</p> <p>Wiring according to the wire color of F9GT-HCAB1-□□M</p> <p>Old cable description New cable description</p>	<p>To computer link unit side (PLC side)</p>  <p>9-pin D-Sub, male</p> <p>Wire the power supply, the operation switches and the emergency stop switch.</p>
f)	<p><b>Q computer link</b></p> <p>Connect to the terminating resistor on the computer link unit side. For details, refer to the User's manual of the computer link unit.</p>	<p><b>RS-422 connection</b></p> <p>To F9GT-HCNB</p>  <p>9-pin D-Sub, male</p>	<p>FG (Grounding) ←→ FG (Grounding)</p> <p>(1) ←→ RXD+(RDA) (6) ←→ RXD-(RDB) (2) ←→ TXD+(SDA) (7) ←→ TXD-(SDB) (5) ←→ SG (GND)</p> <p>Signal name of computer link</p>	<p>Terminal block</p> <p>To serial communication unit side (PLC side)</p>



### 11.8 Troubleshooting

For reference, this section summarizes frequently asked questions about connection of the GOT-F900 to the Q Series PLC.

#### 1) GOT-F900

Contents of trouble	Check points and countermeasures	OS version			
		F940W	F940	F930	F920
<p>"COMMUNICATION ERROR OCCURS" is displayed when a screen changeover or numeric data input is performed on the GOT-F900 screen by a touch key *1.</p> <p>*1 No touch key is available on the F920GOT-K.</p>	<p>The power of the Q Series PLC is turned off.</p> <ul style="list-style-type: none"> <li>• Cause Communication is disabled because the power of the Q Series PLC is turned off.</li> <li>• Countermeasures Turn on the power.</li> </ul> <p>Something is wrong with the cable between the GOT-F900 and the Q Series PLC.</p> <ul style="list-style-type: none"> <li>• Causes The wrong cable is used or the connection is bad.</li> <li>• Countermeasures Check the cable.</li> </ul>	From first product	From first product	From first product	From first product
<p>"DISPLAY SCREEN IS NOT AVAILABLE." is displayed on the GOT-F900 screen.</p>	<p>Changeover to a nonexistent screen by a touch key or the Q Series PLC was tried.</p> <ul style="list-style-type: none"> <li>• Cause The changeover destination screen has not been created yet.</li> <li>• Countermeasures Create the screen.</li> </ul>	-	Earlier than 6.00	Earlier than 4.00	-
<p>"DISPLAY SCREEN IS NOT AVAILABLE. (NO. #####)" is displayed on the GOT-F900 screen.</p>	<p>A nonexistent screen was tried to be displayed.</p> <ul style="list-style-type: none"> <li>• Cause The screen No. ##### has not been created yet.</li> <li>• Countermeasures Create the screen.</li> </ul>	From first product	6.00 or later	4.00 or later	From first product

Contents of trouble	Check points and countermeasures	OS version			
		F940W	F940	F930	F920
"DISPLAY SCREEN IS NOT AVAILABLE." is displayed on the GOT-F900 screen.	A device that does not exist in the Q Series PLC was referenced.  <ul style="list-style-type: none"> <li>• Cause On the changeover destination screen (excluding the head screen), a nonexistent device in the connected Q Series PLC is specified.</li> <li>• Countermeasures Check the devices used on the head screen.</li> </ul>				
	When a PLC is not connected, the GOT defaults to the A mode.  <ul style="list-style-type: none"> <li>• Cause Check for the A or Q Series was executed, the connection mode was automatically changed over, then the device range was checked. This error occurs when the device range set on the changeover destination screen (excluding the head screen) is beyond the range for the A Series.</li> <li>• Countermeasures Connect the PLC.</li> </ul>	–	Earlier than 6.00	Earlier than 4.00	–
	There is an error on the screen to be displayed.  <ul style="list-style-type: none"> <li>• Cause One of the screen objects is placed outside the available screen area.</li> <li>• Countermeasures Check the placement of screen objects.</li> </ul>				
"DISPLAY SCREEN IS NOT AVAILABLE. (NO. ####)" is displayed on the GOT-F900 screen.	The display screen contains an error.  <ul style="list-style-type: none"> <li>• Causes A device that does not exist in the connected PLC is referenced on the screen No. ####, or one of the screen objects is placed outside the available screen area.</li> <li>• Countermeasures Check the devices used and placement of screen objects.</li> </ul>	From first product	6.00 or later	4.00 or later	From first product

Contents of trouble	Check points and countermeasures	OS version			
		F940W	F940	F930	F920
"DATA IS NOT FOUND." is displayed on the GOT-F900 screen.	<p>There is not data because the unit is new or the memory clear has been executed.</p> <ul style="list-style-type: none"> <li>• Cause There is no screen data.</li> <li>• Countermeasures Write the screen data using the screen creation software.</li> </ul>				
	<p>A device that does not exist in the Q Series PLC was referenced.</p> <ul style="list-style-type: none"> <li>• Cause On the head screen, a nonexistent device in the connected Q Series PLC is specified. (The head screen is the screen No. 1 in the GT Designer, and the screen No. 0 in the DU/WIN.)</li> <li>• Countermeasures Check the devices used on the head screen.</li> </ul>	–	Earlier than 6.00	Earlier than 4.00	–
	<p>While the Q Series PLC is not connected, the connection mode for the A Series PLC is selected.</p> <ul style="list-style-type: none"> <li>• Cause Check for the A or Q Series was executed, the connection mode was automatically changed over, then the device range was checked. This error occurs when the device range set on the head screen is beyond the range for the Q Series. (The head screen is the screen No. 1 in the GT Designer, and the screen No. 0 in the DU/WIN.)</li> <li>• Countermeasures Connect the PLC.</li> </ul>				
	<p>There is not data because the unit is new or the memory clear has been executed.</p> <ul style="list-style-type: none"> <li>• Cause There is no screen data.</li> <li>• Countermeasures Write the screen data using the screen creation software.</li> </ul>	From first product	6.00 or later	4.00 or later	From first product
"CAN NOT WRITE TO PLC MEMORY." is displayed on the GOT-F900 screen.	This error is not displayed.	Earlier than 1.10	Earlier than 6.10	Earlier than 4.10	–
"CAN NOT WRITE." is displayed on the GOT-F900 screen.	This error is not displayed.	1.10 or later	6.10 or later	4.10 or later	From first product
"CAN NOT USE THE FUNCTION WHILE PROTECTED." is displayed on the GOT-F900 screen.	This error is not displayed.	From first product	From first product	From first product	From first product
"PLC IS RUNNING." is displayed on the GOT-F900 screen.	This error is not displayed.	From first product	From first product	From first product	From first product

11

Connection of MELSEC-Q Series PLC

12

Connection of FX Series Positioning

13

Connection of FREQROL Inverter

14

Connection of Microcomputer

15

Connection of SYSMAC C Series PLC

16

Connection of FLEX-PC N Series PLC

17

Connection of Machine Controller

18

Connection of FP Series PLC

19

Connection of SLC500 Series PLC

20

Connection of SIMATIC S7 Series PLC

2) Software

	Contents of trouble	Check points and countermeasures
<p>Software such as GX Developer and FX/WIN</p>	<p>In the personal computer connected to the GOT-F900, sequence programs cannot be monitored or transferred. Communication with the sequence software is disabled. An error message is displayed.</p>	<p>PLC, bar code reader or printer is connected.</p> <ul style="list-style-type: none"> <li>• Causes The RS-232C connector to which the personal computer is connected is set to be used for another piece of equipment.</li> <li>• Countermeasures For monitoring or transferring sequence programs, set a bar code reader to invalid and a printer to "DON'T USE". If the PLC is connected, select the GOT-F900 equipped with two built-in RS-232C channels.</li> </ul> <hr/> <p>Something is wrong with the cable between the GOT-F900 and the personal computer.</p> <ul style="list-style-type: none"> <li>• Causes The wrong cable is used or the connection is bad.</li> <li>• Countermeasures Check the cable.</li> </ul>
<p>Screen creation software</p>	<p>Communication with the screen creation software and screen data cannot be transferred.</p>	<p>Q computer link, bar code reader or printer is connected.</p> <ul style="list-style-type: none"> <li>• Causes The RS-232C connector to which the personal computer is connected is set to be used for another piece of equipment.</li> <li>• Countermeasures In the GOT-F900, select by hand "SELECT MODE"-"OTHER MODE"-"DATA TRANSFER". Or set a bar code reader to invalid and a printer to "DON'T USE".</li> </ul> <hr/> <p>Something is wrong with the cable between the GOT-F900 and the personal computer.</p> <ul style="list-style-type: none"> <li>• Causes The connected cable is not proper. Or cable connection is not correct.</li> <li>• Countermeasures Check the cable.</li> </ul>

## 12. Connection of FX Series Positioning Unit (FX(2N)-10/20GM)

This chapter explains connection of the GOT-F900 Series display unit to some FX Series positioning units.

### Connection Procedure

This section introduces the procedure to connect the GOT-F900 to the FX Series positioning unit.

#### 1. Preparation

Item name	Description	Reference
System Condition	You can learn the connection availability as well as the version of the GOT-F900 OS and the screen creation software.	12.1
System Configuration	You can select the configuration between the GOT and the FX Series positioning unit and proper cables.	12.2

#### 2. Setting

Item name	Description	Reference
FX Positioning Unit Selection	When GMCPU connection is selected, the GOT-F900 is automatically set to fixed values. No setting is required in the FX Positioning unit.	–
Cautions	You can learn the restrictions in connecting the GOT to the FX Series positioning unit.	12.3
Setting of Connected Equipment for GOT	Set the PLC type using the GOT or the screen creation software.	12.4

#### 3. Others

Item name	Description	Reference
Cable Diagram	Cable diagrams for FX Series positioning unit/GOT connection	12.5
Troubleshooting	Description of errors and how to fix them	12.6

### 12.1 System Condition

When connecting the FX Series positioning unit, check the COM port designation, the OS version of the GOT-F900, and the applicable version of the screen creation software.

Compatibility when connecting FX Series positioning unit

GOT-F900 Series	COM port		Connection type		OS version of GOT-F900	Version of screen creation software		
	RS-422	RS-232C	1:1	Two or more GOT units		GT Designer2	GT Designer	DU/WIN
F920GOT-K	–	–	–	–	–	–	–	–
F930GOT	✓	–	✓	–	4.10	SW1-C	SW5-K	2.50
F930GOT-K	✓	–	✓	–	4.60	SW1-C	SW5-26C	2.70
F940GOT	✓	–	✓	–	6.10	SW1-C	SW5-K	2.50
F940WGOT	✓	–	✓	–	1.10	SW1-C	SW5-K	2.50
F940 Handy GOT	✓	–	✓	–	6.10	SW1-C	SW5-K	2.50
F943 Handy GOT	–	–	It cannot be connected. Select the F940 handy GOT.					

- The screen creation software version corresponds to the model of the GOT-F900 Series. Refer to section 3.2.

## 12.2 System Configuration

This section explains the cables required to connect the FX Series positioning unit via RS-422. (It does not mean connection to the FX Series PLC CPU.)

### 12.2.1 Applicable model

The GOT-F900 can be connected to the following equipment in accordance with its OS version. Operations are not assured when the GOT-F900 is connected to any other equipment. For details of the OS version of the GOT-F900 and applicable equipment, refer to "3.1 OS Version and Correspondence to Connected Equipment of GOT-F900".

CPU	OPTION	COMMUNICATION PORT
FX2N-10GM FX2N-20GM FX-10GM FX-20GM E-20GM	-	Connection to programming port

### 12.2.2 Configuration for GMCPU direct connection (RS-422)

The FX Series positioning unit is equipped with a built-in RS-422 interface for positioning program. The GOT-F900 can be connected directly to this interface.

#### 1) F930GOT/F930GOT-K/F940GOT/F940WGOT

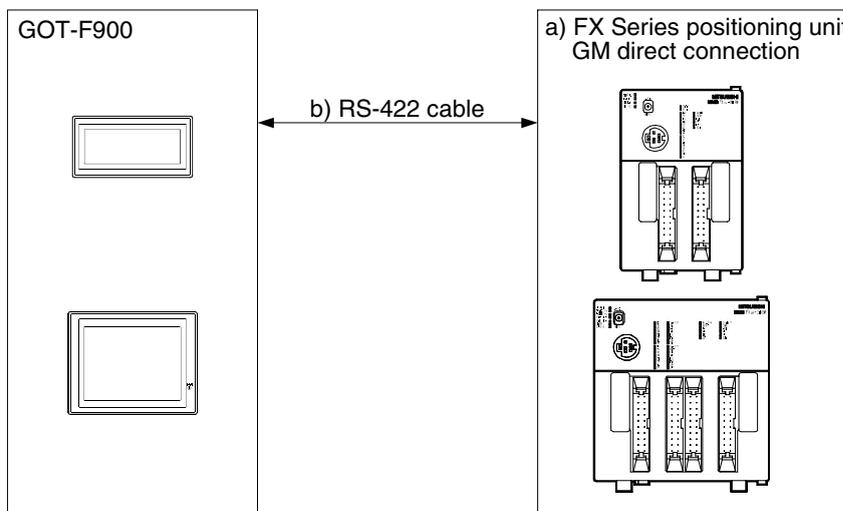

a) GM CPU		b) RS-422 cable	Remarks
FX2N-10GM FX2N-20GM	8-pin MINI DIN	FX-50DU-CAB0 FX-50DU-CAB0L	Equivalent to the 8-pin MINI DIN port of the FX Series PLC
FX-10GM FX-20GM E-20GM	20-pin D-Sub	FX-30DU-GM-CAB	

- The L type cable, FX-50DU-CAB0L (cable with a right angle connector), cannot be used for F930GOT or F930GOT-K.

2) F940 Handy GOT

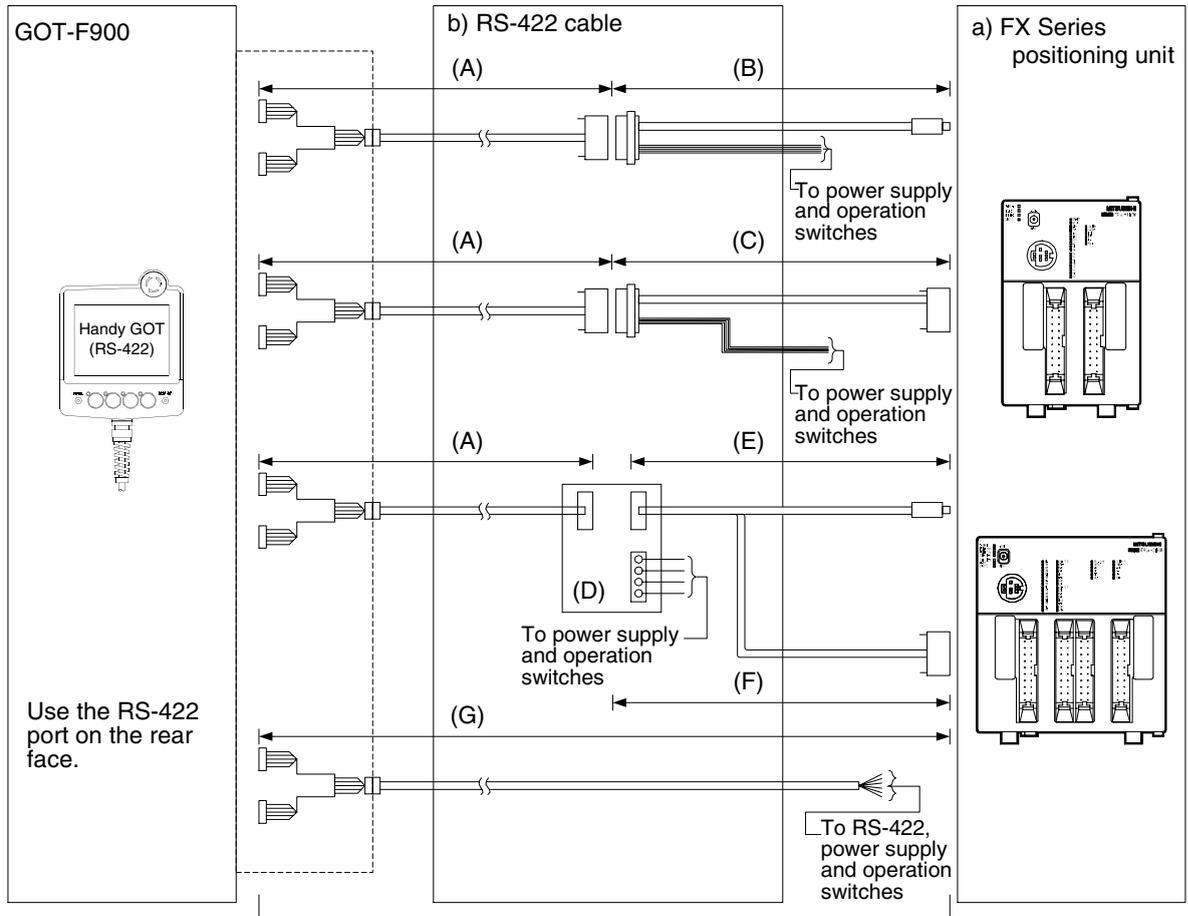

a) GM CPU		b) RS-422 cable	Remarks
FX2N-10GM FX2N-20GM	8-pin MINI DIN	(A) F9GT-HCAB-□□M (B) F9GT-HCAB2-150 (D) F9GT-HCNB (E) FX-50DU-CAB0 or FX-50DU-CAB0-1M (G) F9GT-HCAB1-□□M	Equivalent to the 8-pin MINI DIN connector of the FX Series PLC
FX-10GM FX-20GM E-20GM	20-pin D-Sub	(A) F9GT-HCAB-□□M (C) Prepared by the user. (D) F9GT-HCNB (F) FX-30DU-GM-CAB (G) F9GT-HCAB1-□□M	

- Make sure that the total cable extension distance (A) + "(B) or (C)" is 11.5m (37' 9") or less.

## 12.3 Cautions on use of FX Series positioning unit

When using the GOT-F900 connected to the FX Series positioning unit, observe the following cautions on use.

### 12.3.1 Device specification

The device range specifications vary depending on the model of the FX Series positioning unit as shown in the table below.

Device name and Nos. which can be monitored in GOT	FX2N-10GM FX-10GM	FX2N-20GM FX-20GM E-20GM
Input relay (X) *1 X000~X377	X000~X003 X375~X377	X000~X007 X010~X067(when I/Os are extended) X372~X377
Output relay (Y) Y0~Y67	Y00~Y05	Y00~Y67
Auxiliary relay (M) M0~M511	M0~M511	M0~M511
Special auxiliary relay (M) M9000~M9175	M9000~M9175	M9000~M9175
Data register (D) D0~D3999	D0~D1999	D0~D3999
File register (D) D4000~D6999	D4000~D6999	D4000~D6999
Special data register (D) D9000~D9599	D9000~D9313	D9000~D9599
Index register (V, Z) *2 V0~V7 Z0~Z7(32 bits)	V0~V7 Z0~Z7(32 bits)	V0~V7 Z0~Z7(32 bits)

\*1 Input relays (X) X000 to X377 can be read only.

\*2 When a screen is created using the DU/WIN, only V and Z are available as index registers.

### 12.3.2 Devices which can be monitored

Among bit devices, specify the device number of input relays (X) and output relays (Y) in octal (1, 2, 3 . . . 7, 10, 11 . . . 17, 20). Specify the device number of other bit devices in decimal.

When specifying word devices, use the zero suppression function.

Only devices described in chapter 3.3 can be specified.

### 12.3.3 Caution on connection of a programming tool to the FX Series positioning unit

When programming the positioning unit, the GOT-F900 should be disconnected from the programming port of the GMCPU.

(Positioning programs cannot be transferred or monitored from a personal computer connected to the GOT-F900.)



## 12.4 Setting of Connected Equipment for GOT

The setting for connection to the FX Series positioning unit can be executed using the GOT-F900 and the screen creation software (GT Designer2, GT Designer or DU/WIN).

### 1) GOT-F900 Series

When the main menu screen change operation is disabled.

Operation	Display (screen name)
a) While pressing and holding the upper left corner of the screen, turn on the power. Keep holding the upper left corner for about 25 seconds more. Then, press "END" at the upper right corner.	The "LANGUAGE" screen appears.
b) Press "PLC TYPE".	The "SET-UP MODE" screen appears.
c) Set the following. PLC TYPE:FX-GM SERIES CONNECTION:CPU PORT (RS-422) DST STATION # (STATION #) : 00 GOT STATION # (-) : -	The "PLC TYPE" screen appears.

When the main menu screen change operation is enabled.

Operation	Display (screen name)
a) Press the upper left corner of the screen. (The position to be pressed can be changed in the GOT and the screen creation software.)	The "SELECT MODE" screen appears.
b) Press "OTHER MODE" on the menu.	The "OTHER MODE" screen appears.
c) Press "SET-UP MODE" on the menu.	The "SET-UP MODE" screen appears.
d) Press "PLC TYPE".	The "PLC TYPE" screen appears.
e) Set the following. PLC TYPE: FX-GM SERIES CONNECTION:CPU PORT (RS-422) DST STATION # (STATION #) : 00 GOT STATION # (-) : -	

- When the screen data is transferred to the GOT-F900, the old data including the PLC type, connection type, and station number are overwritten.

- 11 Connection of MELSEC-Q Series PLC
- 12 Connection of FX Series Positioning
- 13 Connection of FREQROL Inverter
- 14 Connection of Microcomputer
- 15 Connection of SYSMAC C Series PLC
- 16 Connection of FLEX-PC N Series PLC
- 17 Connection of Machine Controller
- 18 Connection of FP Series PLC
- 19 Connection of SLC500 Series PLC
- 20 Connection of SIMATIC S7 Series PLC



Operation		Display (screen name)
	e)Set the following. Port : RS-422 Type : CPU Station No. : 00 GOT Station No. : -	
[Change method]	Change the connection type of the already created data as follows. a)Open GT Designer2. b)Click the [Project]-[Open] button. c)Open (read) the screen data to be changed. d)On the menu, select "Common"- "System Environment". - For the contents of setting, refer to c) of [Creation] above. - For selection of the RS-422 on the FX Series positioning unit, refer to e) of [Creation] above.	The "Select Project" dialog box appears.  The "System Environment" dialog box appears.

11

Connection of MELSEC-Q Series PLC

12

Connection of FX Series Positioning

13

Connection of FREQROL Inverter

14

Connection of Microcomputer

15

Connection of SYSMAC C Series PLC

16

Connection of FLEX-PC N Series PLC

17

Connection of Machine Controller

18

Connection of FP Series PLC

19

Connection of SLC500 Series PLC

20

Connection of SIMATIC S7 Series PLC



Operation		Display (screen name)
[Change method]	Change the connection type of the already created data as follows. a) Open GT Designer. b) Click the [Open] button. c) Open (read) the screen data to be changed. d) On the menu, select "Common"- "GOT/PLC Type". - For the contents of setting, refer to c) of [Creation] above. - For selection of the RS-422 on the FX Series positioning unit, refer to e) of [Creation] above.	The "Select Project" dialog box appears.       The "GOT/PLC Type" dialog box appears.

11

Connection of MELSEC-Q Series PLC

12

Connection of FX Series Positioning

13

Connection of FREQROL Inverter

14

Connection of Microcomputer

15

Connection of SYSMAC C Series PLC

16

Connection of FLEX-PC N Series PLC

17

Connection of Machine Controller

18

Connection of FP Series PLC

19

Connection of SLC500 Series PLC

20

Connection of SIMATIC S7 Series PLC

4) DU/WIN

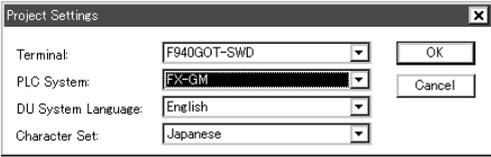
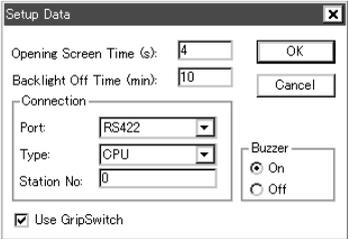
	Operation	Display (screen name)										
[Creation]	<p>a) Open DU/WIN.</p> <p>b) On the menu, select "File"-"New".</p>  <p>c) Set the following.                      Terminal: F940WGOT-TWD (V)(H)                      F940GOT-LWD                      F940GOT-SWD                      F930GOT-BWD (V)(H)                      PLC System: FX-GM</p> <p>Select "Terminal" in accordance with the LC display color.</p> <table border="1" data-bbox="464 819 1134 1111"> <thead> <tr> <th>Terminal</th> <th>Model name</th> </tr> </thead> <tbody> <tr> <td>F940WGOT-TWD (V)(H)</td> <td>F940WGOT (color)</td> </tr> <tr> <td>F940GOT-LWD</td> <td>F940GOT (black and white) Handy GOT (black and white)</td> </tr> <tr> <td>F940GOT-SWD</td> <td>F940GOT (color) Handy GOT (color)</td> </tr> <tr> <td>F930GOT-BWD (V)(H)</td> <td>F930GOT-K (blue) F930GOT (blue)</td> </tr> </tbody> </table> <p>d) Set RS-422 of the GOT-F900.                      On the menu, select "View/Project"-"System Settings"-"Setup Data".</p>  <p>e) Set the following.                      Port: RS-422                      Type: CPU                      DST Station No. (Station No.): 00                      GOT Station No. (-) : -  <u>In the case of F943 Handy GOT</u>                      Without regard to the port setting (RS-422 or RS-232C), the COM0 side of the RS-232C is fixed for PLC connection.</p>	Terminal	Model name	F940WGOT-TWD (V)(H)	F940WGOT (color)	F940GOT-LWD	F940GOT (black and white) Handy GOT (black and white)	F940GOT-SWD	F940GOT (color) Handy GOT (color)	F930GOT-BWD (V)(H)	F930GOT-K (blue) F930GOT (blue)	<p>The "Project settings" dialog box appears.</p> <p>The "Setup Data" dialog box appears.</p>
Terminal	Model name											
F940WGOT-TWD (V)(H)	F940WGOT (color)											
F940GOT-LWD	F940GOT (black and white) Handy GOT (black and white)											
F940GOT-SWD	F940GOT (color) Handy GOT (color)											
F930GOT-BWD (V)(H)	F930GOT-K (blue) F930GOT (blue)											
[Change method]	<p>Change the connection type of the already created data as follows.</p> <p>a) Open DU/WIN.</p> <p>b) On the menu, select "File"-"Open".</p> <p>c) Select and open (read) the file of the screen data to be changed.</p> <p>d) When changing "Terminal" (GOT-F900), select "View/Project"-"System Settings"-"Project settings" on the menu.                      For the contents of setting, refer to c) in [Creation] above.                      For setting of RS-232C/RS-422 of the FX Series positioning unit, refer to e) in [Creation] above.</p>	<p>The "Open" dialog box appears.</p> <p>The "Project settings" dialog box appears.</p>										

## 12.5 Cable Diagram

This section explains cable diagrams to connect the GOT-F900 and the FX Series positioning unit.

### 12.5.1 Cautions on preparing cables

When preparing the cables, use the wire size of 0.08mm<sup>2</sup> or more (AWG28 or more) for communication, 0.3mm<sup>2</sup> or more (AWG22 or more) for the power supply, operation switch, and emergency stop switch. Do not use a twisted pair cable with the power supply wire and the communication wire.

### 12.5.2 Cable diagram

#### 1) Cable for the GOT and the FX Series positioning unit

 : Female type  : Male type The connector figure shows the engagement face.

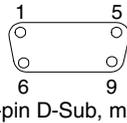
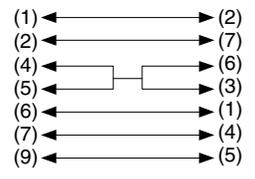
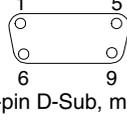
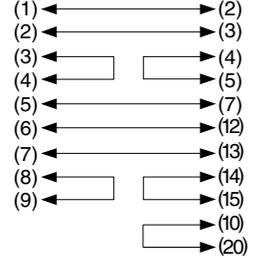
No.	Model name	Application	Connection diagram	Application
a)	<p><b>FX Series positioning unit connection</b></p> <p>RS-422 connection</p> <p>FX-50DU-CAB0 FX-50DU-CAB0/EN FX-50DU-CAB0-1M FX-50DU-CAB0L</p>	<p>To GOT-F900</p>  <p>9-pin D-Sub, male</p>	 <p>To FX2N-10GM, FX2N-20GM</p> <p>8-pin MINI DIN, male</p>	
b)	<p><b>FX Series positioning unit connection</b></p> <p>RS-422 connection</p> <p>FX-30DU-GM-CAB</p>	<p>To GOT-F900</p>  <p>9-pin D-Sub, male</p>	 <p>To FX-10GM, E-20GM, FX-20GM</p> <p>20-pin D-Sub, male</p>	

2) Cable for the Handy GOT and the FX Series positioning unit

When using the Handy GOT RH model, refer to the cable diagrams below for the RS-422/RS-232C connector, but not the wiring for the power supply, the operation switches, and the emergency stop switch because it is different. For details, refer to Sevtion 5.18.

 : Female type  : Male type The connector figure shows the engagement face.

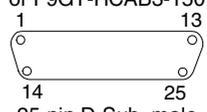
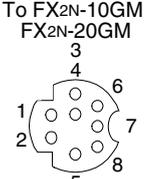
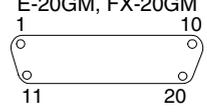
No.	Model name	Application	Connection diagram	Application
a)	F9GT-HCAB-3M F9GT-HCAB-10M	RS-422 connection Dedicated connector RS-232C connection	The connector on the leader side of the Handy GOT is dedicated, and cannot be prepared by the user.	To F9GT-HCAB2-150 or F9GT-HCAB3-150  25-pin D-Sub, male
b)	F9GT-HCAB1-3M F9GT-HCAB1-10M	RS-422 connection Dedicated connector RS-232C connection	The connector on the leader side of the Handy GOT is dedicated, and cannot be prepared by the user.	Loose wires (no connector)
c)	F9GT-HCAB2-150	RS-422 connection	<p>Wiring according to the pin number of F9GT-HCAB-□□M</p> <p>Drain wire (1) → FG (Grounding)</p> <p>To cable F9GT-HCAB on Handy GOT side</p> <p>25-pin D-Sub, female</p> <p>13 1 25 14</p> <p>                     BK(2) → (2)                      W (3) → (1)                      Y (6) → (7)                      BR(7) → (4)                      BL(8) → (6)                      GR(9) → (5)                      O (10) → (3)                 </p> <p>SHELL</p> <p>PL (12) → DC24VG                      PK (13) → DC24VG                      LTGR (14) → SW-COM / ES1-2                      SB (15) → SW1 / DSW2                      BK/W (16) → SW2 / DSW2                      R/W (17) → SW3 / DSW1                      GR/W (18) → SW4 / DSW1                      O/W (20) → / ES1-2                      Y/W (21) → ES1 / ES1-1                      BR/W (22) → ES1 / ES1-1                      BL/W (24) → DC24V+                      GY/W (25) → DC24V+</p> <p>Wiring according to the wire color of F9GT-HCAB1-□□M</p> <p>To FX2N-10GM, FX2N-20GM</p> <p> 8-pin MINI DIN, male</p> <p>Wire the power supply, the operation switches and the emergency stop switch.</p> <p>Old cable description New cable description</p>	
d)	Prepared by the user	RS-422 connection	<p>Wiring according to the pin number of F9GT-HCAB-□□M</p> <p>Drain wire (1) → FG (Grounding)</p> <p>To cable F9GT-HCAB on Handy GOT side</p> <p>25-pin D-Sub, female</p> <p>13 1 25 14</p> <p>                     BK(2) → (2)                      W (3) → (12)                      R (4) → (4)                      GR(5) → (5)                      Y (6) → (3)                      BR(7) → (13)                      BL(8) → (14)                      GR(9) → (15)                      O (10) → (7)                 </p> <p>Hood</p> <p>PL (12) → DC24VG                      PK (13) → DC24VG                      LTGR (14) → SW-COM / ES1-2                      SB (15) → SW1 / DSW2                      BK/W (16) → SW2 / DSW2                      R/W (17) → SW3 / DSW1                      GR/W (18) → SW4 / DSW1                      O/W (20) → / ES1-2                      Y/W (21) → ES1 / ES1-1                      BR/W (22) → ES1 / ES1-1                      BL/W (24) → DC24V+                      GY/W (25) → DC24V+</p> <p>Wiring according to the wire color of F9GT-HCAB1-□□M</p> <p>To FX-10GM, E-20GM, FX-20GM</p> <p> 20-pin D-Sub, male</p> <p>Wire the power supply, the operation switches and the emergency stop switch.</p> <p>Old cable description New cable description</p>	

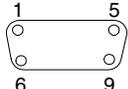
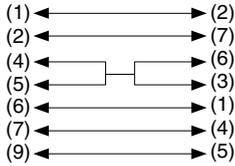
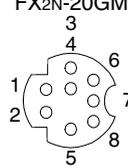
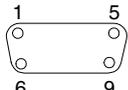
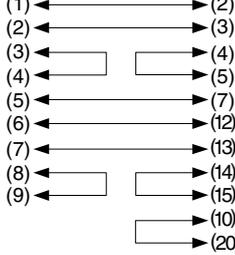
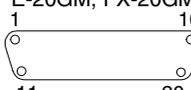

 : Female type  : Male type The connector figure shows the engagement face.

No.	Model name	Application	Connection diagram	Application
e)	<p>FX Series positioning unit connection</p> <p>FX-50DU-CAB0</p> <p>FX-50DU-CAB0-1M</p> <p>FX-50DU-CAB0L</p>	<p>RS-422 connection</p> <p>To F9GT-HCNB</p>  <p>9-pin D-Sub, male</p>		<p>To FX2N-10GM, FX2N-20GM</p>  <p>8-pin MINI DIN, male</p>
f)	<p>FX Series positioning unit connection</p> <p>FX-30DU-GM-CAB</p>	<p>RS-422 connection</p> <p>To F9GT-HCNB</p>  <p>9-pin D-Sub, male</p>		<p>To FX-10GM, E-20GM, FX-20GM</p>  <p>20-pin D-Sub, male</p>

11 Connection of MELSEC-Q Series PLC

12 Connection of FX Series Positioning

13 Connection of FREQROL Inverter

14 Connection of Microcomputer

15 Connection of SYSMAC C Series PLC

16 Connection of FLEX-PC N Series PLC

17 Connection of Machine Controller

18 Connection of FP Series PLC

19 Connection of SLC500 Series PLC

20 Connection of SIMATIC S7 Series PLC

## 12.6 Troubleshooting

For reference, this section summarizes frequently asked questions about connection of the GOT-F900 to the FX Series positioning unit.

### 1) GOT-F900

Contents of trouble	Check points and countermeasures	OS version		
		F940W	F940	F930
"COMMUNICATION ERROR OCCURS" is displayed when a screen changeover or numeric data input is performed on the GOT-F900 screen.	<p>The power of the FX Series positioning unit is turned off.</p> <ul style="list-style-type: none"> <li>• Cause Communication is disabled because the power of the FX Series positioning unit is turned off.</li> <li>• Countermeasures Turn on the power.</li> </ul>	From first product	From first product	From first product
	<p>Something is wrong with the cable between the GOT-F900 and the FX Series positioning unit.</p> <ul style="list-style-type: none"> <li>• Causes The wrong cable is used or the connection is bad.</li> <li>• Countermeasures Check the cable.</li> </ul>			
"DISPLAY SCREEN IS NOT AVAILABLE." is displayed on the GOT-F900 screen.	<p>Changeover to a nonexistent screen by a touch key or the FX Series positioning unit was tried.</p> <ul style="list-style-type: none"> <li>• Cause The changeover destination screen has not been created yet.</li> <li>• Countermeasures Create the screen.</li> </ul>	–	Earlier than 6.00	Earlier than 4.00
"DISPLAY SCREEN IS NOT AVAILABLE. (NO. ####)" is displayed on the GOT-F900 screen.	<p>A nonexistent screen was tried to be displayed.</p> <ul style="list-style-type: none"> <li>• Cause The screen No. #### has not been created yet.</li> <li>• Countermeasures Create the screen.</li> </ul>	From first product	6.00 or later	4.00 or later
"DISPLAY SCREEN IS NOT AVAILABLE." is displayed on the GOT-F900 screen.	<p>A device that does not exist in the FX Series positioning unit was referenced. (Example: While the FX2N-10GM was connected, a device provided only in the FX2N-20GM was specified for numeric input.)</p> <ul style="list-style-type: none"> <li>• Cause On the changeover destination screen (excluding the head screen), a nonexistent device in the connected FX Series positioning unit is specified.</li> <li>• Countermeasures Check the devices used on the head screen.</li> </ul>	–	Earlier than 6.00	Earlier than 4.00
	<p>There is an error on the screen to be displayed.</p> <ul style="list-style-type: none"> <li>• Cause One of the screen objects is placed outside the available screen area.</li> <li>• Countermeasures Check the placement of screen objects.</li> </ul>			

Contents of trouble	Check points and countermeasures	OS version		
		F940W	F940	F930
"DISPLAY SCREEN IS NOT AVAILABLE. (NO. ####)" is displayed on the GOT-F900 screen.	<p>The display screen contains an error.</p> <ul style="list-style-type: none"> <li>Causes A device that does not exist in the connected PLC is referenced on the screen No. ####, or one of the screen objects is placed outside the available screen area.</li> <li>Countermeasures Check the devices used and placement of screen objects.</li> </ul>	From first product	6.00 or later	4.00 or later
"DATA IS NOT FOUND." is displayed on the GOT-F900 screen.	<p>There is not data because the unit is new or the memory clear has been executed.</p> <ul style="list-style-type: none"> <li>Cause There is no screen data.</li> <li>Countermeasures Write the screen data using the screen creation software.</li> </ul>	-	Earlier than 6.00	Earlier than 4.00
	<p>A device that does not exist in the FX Series positioning unit was referenced. (Example: While the FX2N-10GM was connected, a device provided only in the FX2N-20GM was specified for numeric input.)</p> <ul style="list-style-type: none"> <li>Cause On the head screen, a nonexistent device in the connected FX Series positioning unit is specified. (The head screen is the screen No. 1 in the GT Designer, and the screen No. 0 in the DU/WIN.)</li> <li>Countermeasures Check the devices used on the head screen.</li> </ul>			
	<p>There is not data because the unit is new or the memory clear has been executed.</p> <ul style="list-style-type: none"> <li>Cause There is no screen data.</li> <li>Countermeasures Write the screen data using the screen creation software.</li> </ul>			
"CAN NOT WRITE TO PLC MEMORY." is displayed on the GOT-F900 screen.	This error is not displayed.	Earlier than 1.10	Earlier than 6.10	Earlier than 4.10
"CAN NOT WRITE." is displayed on the GOT-F900 screen.	This error is not displayed.	1.10 or later	6.10 or later	4.10 or later
"CAN NOT USE THE FUNCTION WHILE PROTECTED." is displayed on the GOT-F900 screen.	This error is not displayed.	From first product	From first product	From first product
"PLC IS RUNNING." is displayed on the GOT-F900 screen.	This error is not displayed.	From first product	From first product	From first product

11

Connection of MELSEC-Q Series PLC

12

Connection of FX Series Positioning

13

Connection of FREQROL Inverter

14

Connection of Microcomputer

15

Connection of SYSMAC C Series PLC

16

Connection of FLEX-PC N Series PLC

17

Connection of Machine Controller

18

Connection of FP Series PLC

19

Connection of SLC500 Series PLC

20

Connection of SIMATIC S7 Series PLC

## 2) Software

	Contents of trouble	Check points and countermeasures
Screen creation software	Communication with the screen creation software and screen data cannot be transferred.	<p>An FX Series positioning unit, bar code reader or printer is connected.</p> <ul style="list-style-type: none"> <li>• Causes The RS-232C connector to which the personal computer is connected is set to be used for another piece of equipment.</li> <li>• Countermeasures In the GOT-F900, select by hand "SELECT MODE"-"OTHER MODE"-"DATA TRANSFER". Or set a bar code reader to invalid and a printer to "DON'T USE".</li> </ul>
		<p>Something is wrong with the cable between the GOT-F900 and the personal computer.</p> <ul style="list-style-type: none"> <li>• Causes The connected cable is not proper. Or cable connection is not correct.</li> <li>• Countermeasures Check the cable.</li> </ul>

## 13. Connection of FREQROL (S500/E500/A500) Inverter

This chapter explains the procedure to connect the GOT-F900 Series display unit to the FREQROL Series (S500/E500/A500) inverter.

### Connection Procedure

This section introduces the procedure to connect the GOT-F900 to the FREQROL Series inverter.

#### 1. Preparation

Item name	Description	Reference
System Condition	You can learn the connection availability as well as the version of the GOT-F900 OS and the screen creation software.	13.1
System Configuration	You can select the configuration between the GOT and the FREQROL inverter and proper cables.	13.2

#### 2. Setting

Item name	Description	Reference
Setting in FREQROL Inverter	When INVCPU connection is selected, the GOT-F900 is automatically set to fixed values. No setting is required in the FREQROL inverter.	13.3
Cautions on Use of FREQROL Series Inverter	You can learn the restrictions in connecting the GOT to the FREQROL inverter.	13.4
Correspondence between GOT Devices and Parameters	You can learn correspondence between GOT devices and parameters as well as communication.	13.5
FREQROL Inverter Parameter List	You can compare parameters of the A500, the E500 and the S500.	13.6
Setting of Connected Equipment for GOT	Set the PLC type using the GOT or the screen creation software.	13.7

#### 3. Others

Item name	Description	Reference
Cable Diagram	Cable diagrams for FREQROL inverter/GOT connection	13.8
Troubleshooting	Description of errors and how to fix them	13.9

## 13.1 System Condition

When connecting the FREQROL Series inverter, check the COM port designation, the OS version of the GOT-F900, and the applicable versions of the screen creation software.

Compatibility when connecting FREQROL (S500/E500/A500) Inverter

GOT-F900 Series	COM port		Connection type		OS version of GOT-F900	Version of screen creation software		
	RS-422	RS-232C	1:1	Two or more GOT units		GT Designer2	GT Designer	DU/WIN
F920GOT-K	–	–	–	–	–	–	–	–
F930GOT	✓	–	✓	–	4.10	SW1-C	SW5-K	2.50
F930GOT-K	✓	–	✓	–	4.60	SW1-C	SW5-26C	2.70
F940GOT	✓	–	✓	–	6.10	SW1-C	SW5-K	2.50
F940WGOT	✓	–	✓	–	1.10	SW1-C	SW5-K	2.50
F940 Handy GOT	✓	–	✓	–	6.10	SW1-C	SW5-K	2.50
F943 Handy GOT	–	–	It cannot be connected. Select the F940 handy GOT.					

- The screen creation software version corresponds to the model of the GOT-F900 Series. Refer to section 3.2.

## 13.2 System Configuration

This section explains the cables required to connect the FREQROL Series inverter through INV direct connection (RS-422). (Up to 10 FREQROL Series inverters can be connected to one GOT-F900 unit.)

### 13.2.1 Applicable model

The GOT-F900 can be connected to the following equipment in accordance with its OS version. Operations are not assured when the GOT-F900 is connected to any other equipment.

For details of the OS version of the GOT-F900 and applicable equipment, refer to "3.1 OS Version and Correspondence to Connected Equipment of GOT-F900".

CPU	OPTION	COMMUNICATION PORT
S500 Series (RS-485 port built-in type only)	–	Connection to RS-485 port
E500 Series (PU port)	–	Connection to PU port
A500 Series	–	Connection to PU port
	FR-A5NR	Connection to FR-A5NR

Though the port of the S500 Series is the RS-485 communication port, it is called "PU port" in this manual.

### 13.2.2 Configuration for CPU Direct Connection (RS-422)

The GOT-F900 can be connected to the FREQROL Series inverter equipped with built-in PU port (A500/E500 Series), the FR-A5NR computer link option (A500 Series) or the S500 Series equipped with the RS-485 communication function.

The GOT-F900 can be directly connected to the interface to control two or more inverters.

#### 1) F930GOT/F930GOT-K/F940GOT/F940WGOT

a) When one inverter is connected

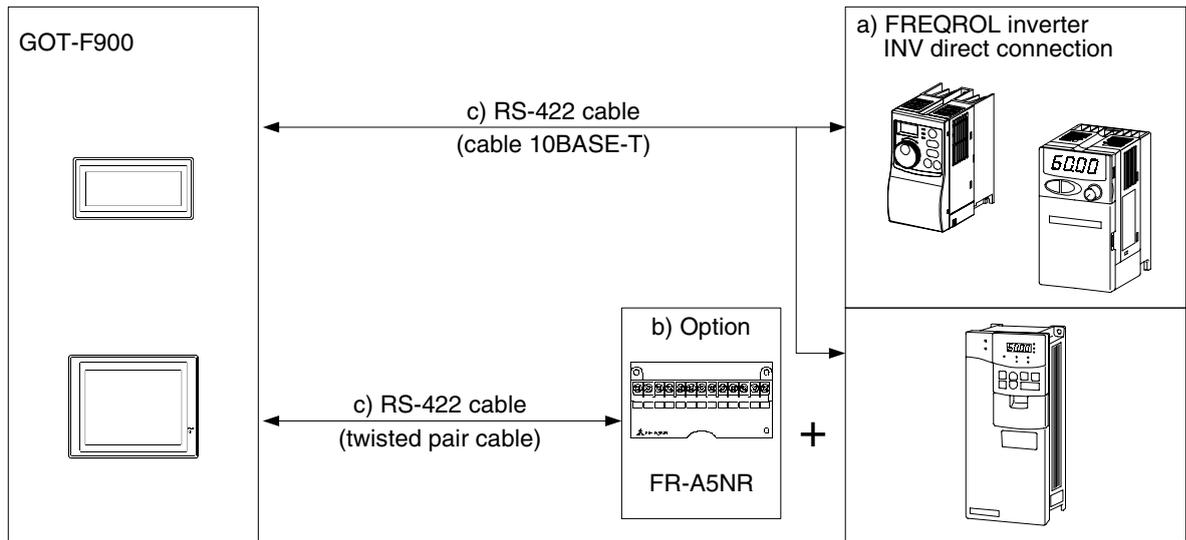

- b) When two or more inverters are connected  
 UP to 10 inverters can be connected through RS-422.

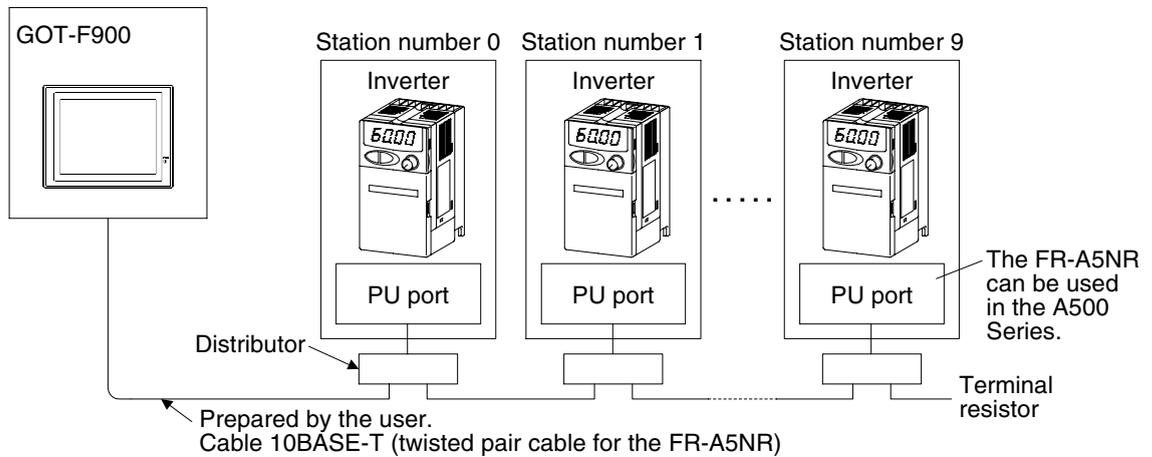

- For connection between the GOT-F900 and the distributor, refer to a) on the previous page.
- For connection between the distributors, prepare connectors and cables while referring to section 13.8 later. Do not use the commercial straight connection type Ethernet 10BASE-T cable (Category 3 or 5). (If this cable is used, inverters will have a short circuit because the pins number 2 and 8 are connected to power supply.)
- Sample products (connector, cable, and distributor) are introduced in Cable Diagram in this chapter.

a) INV		b) Option	c) RS-422 cable	Remarks
S500	PU port		Prepared by the user. (cable 10BASE-T)	It is called "RS-485 communication port".
E500				
A500				
A500		FR-A5NR	Prepared by the user. (twisted pair cable)	Option for computer link connection is required.

The A500 Series can be connected using the PU port or the option for computer link connection. Though the port of the S500 Series is the RS-485 communication port, it is called "PU port" in this manual.

c) Attaching a terminal resistor

Communication may be affected by reflection depending on the transmission speed and the transmission distance. If communication is hindered by this reflection, provide a terminal resistor.

- When the PU port or the RS-485 port is used for connection  
 Attach a terminal resistor between the pin number 3 (RDA) and the pin number 6 (RDB). Because the terminal resistor cannot be attached, use the distributor. Attach the terminal resistor only to the inverter located farthest from the GOT-F900. (terminal resistor: 100Ω, 1/2W)
- When the FR-A5NR is used for connection  
 Attach a terminal resistor chip (included with the FR-A5NR) between the terminals RDB and RDR of the last inverter.



2) F940 Handy GOT (RS-422)

a) When one inverter is connected

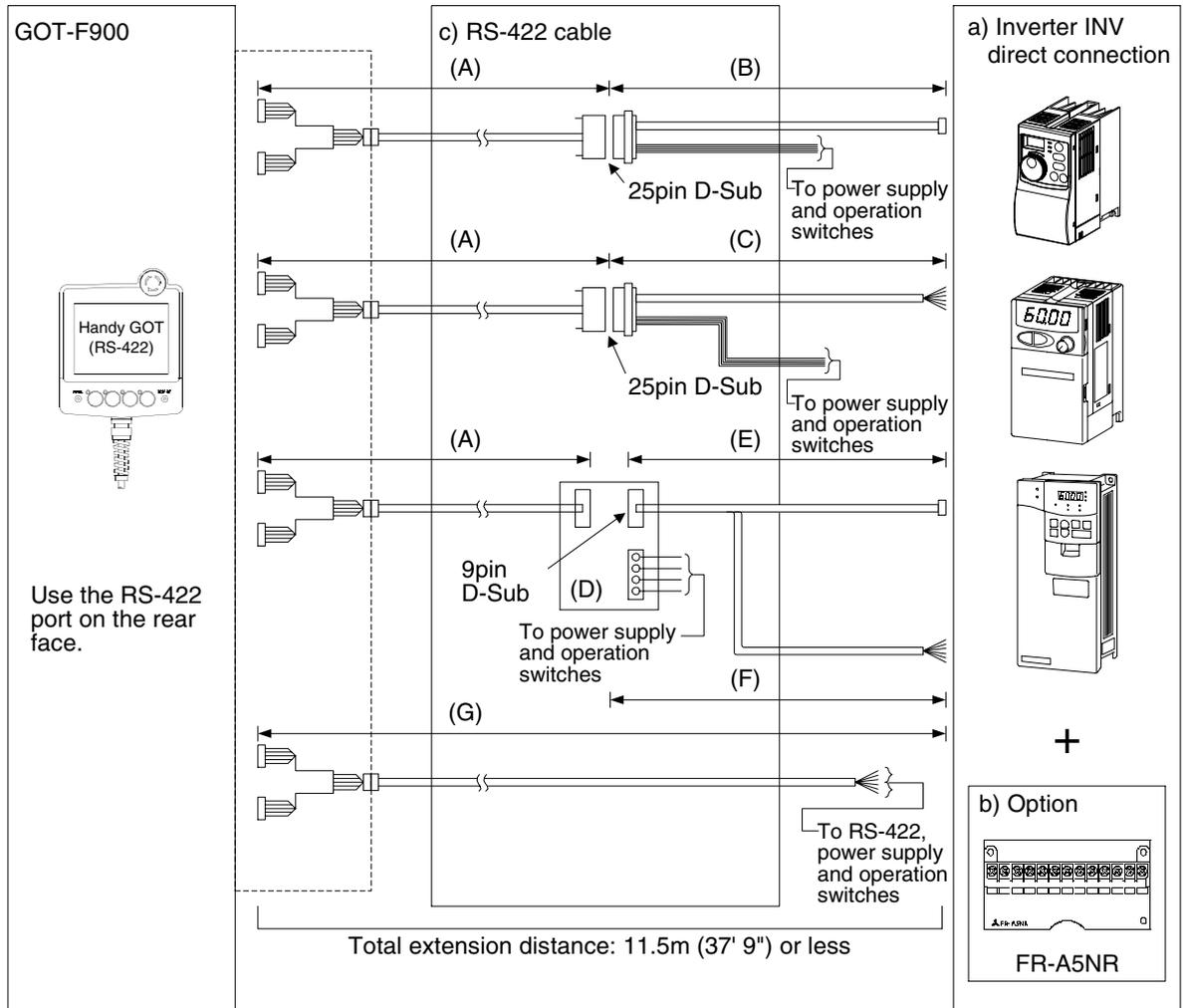

11	Connection of MELSEC-Q Series PLC
12	Connection of FX Series Positioning
13	Connection of FREQROL Inverter
14	Connection of Microcomputer
15	Connection of SYSMAC C Series PLC
16	Connection of FLEX-PC N Series PLC
17	Connection of Machine Controller
18	Connection of FP Series PLC
19	Connection of SLC500 Series PLC
20	Connection of SIMATIC S7 Series PLC

- b) When two or more inverters are connected  
Up to 10 inverters can be connected through RS-422.

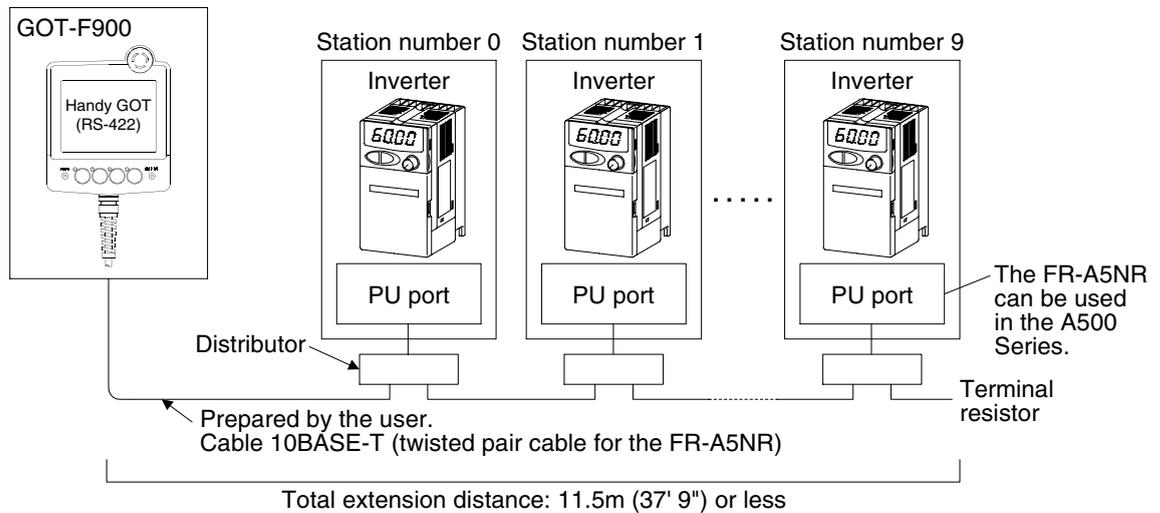

- For connection between the GOT-F900 and the distributor, refer to a) on the previous page.
- For connection between the distributors, prepare connectors and cables while referring to section 13.8 later. Do not use the commercial straight connection type Ethernet 10BASE-T cable (Category 3 or 5). (if this cable is used, inverters will have a short circuit because the pins number 2 and 8 are connected to power supply.)
- Sample products (connector, cable, and distributor) are introduced in Cable Diagram in this chapter.

a) INV		b) Option	c) RS-422 cable	Remarks
S500	PU port		(A) F9GT-HCAB-□□□	It is called "RS-485 communication port".
E500			(B) Prepared by the user. (cable 10BASE-T)	
A500			(D) F9GT-HCNB (E) Prepared by the user. (cable 10BASE-T) (G) F9GT-HCAB1-□□□	
A500		FR-A5NR	(A) F9GT-HCAB-□□□ (C) Prepared by the user. (twisted pair cable) (F) Prepared by the user. (twisted pair cable) (G) F9GT-HCAB1-□□□	Option for computer link connection is required.

The A500 Series can be connected using the PU port or the option for computer link connection. Though the port of the S500 Series is the RS-485 communication port, it is called "PU port" in this manual.

c) Attaching a terminal resistor

Communication may be affected by reflection depending on the transmission speed and the transmission distance. If communication is hindered by this reflection, provide a terminal resistor.

- When the PU port or the RS-485 port is used for connection  
Attach a terminal resistor between the pin number 3 (RDA) and the pin number 6 (RDB). Because the terminal resistor cannot be attached, use the distributor. Attach the terminal resistor only to the inverter located farthest from the GOT-F900. (terminal resistor: 100Ω 1/2W)
- When the FR-A5NR is used for connection  
Attach a terminal resistor chip (included with the FR-A5NR) between the terminals RDB and RDR of the last inverter.

### 13.3 Setting in FREQROL Inverter

When connecting the FREQROL Series inverter, the parameter should be set as described below.

#### 13.3.1 Communication Setting Specifications

This section explains the contents to be set in the FREQROL Series inverter.

##### 1) Setting the transmission specifications

Set the transmission specifications of the inverter to realize the transmission specifications shown in the table below. For the setting method, refer to the manual of the inverter.

For the communication setting parameters, refer to the next section.

Item		RS-422		
Communication speed		19200 bps		
Control protocol		Asynchronous system		
Communication method		Half-duplex method		
Data format	Character system		ASCII (7 bits)	
	Data bit		7 bits	
	Terminator		CR: Provided, CF: Not provided	
	Check system	Parity check	Provided (odd)	
		Sum check	Provided	
	Waiting time setting		Not provided	
Stop bit length		1 bit		

- The specifications such as the transmission speed are fixed on the GOT-F900 side, and cannot be changed.

##### 2) Setting the station number

For the communication setting parameters, refer to the next section.

##### Setting in the Inverter

Set each station number in the range from 00 to 31 while making sure that one station number is used only once.

In the case of RS-422 connection, 10 inverters can be connected at maximum.

The station number can be set without regard to the inverter connection order. No problem is expected even if station numbers are not consecutive.

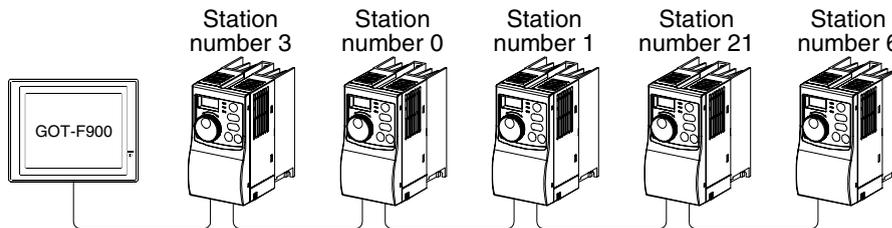

Example of station number setting

##### Setting in the GOT-F900

Leave the station number setting in "00".

11	Connection of MELSEC-Q Series PLC
12	Connection of FX Series Positioning
13	Connection of FREQROL Inverter
14	Connection of Microcomputer
15	Connection of SYSMAC C Series PLC
16	Connection of FLEX-PC N Series PLC
17	Connection of Machine Controller
18	Connection of FP Series PLC
19	Connection of SLC500 Series PLC
20	Connection of SIMATIC S7 Series PLC

### 13.3.2 Setting Examples

#### 1) Communication port and corresponding parameters

When connecting the GOT-F900 to the inverter, parameters corresponding to the communication port should be set.

**S500 Series**  
Remove the front cover.

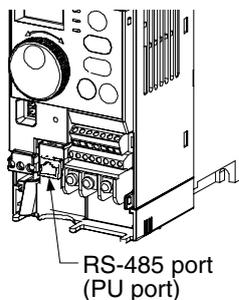

**E500 Series**  
Remove the operation panel.

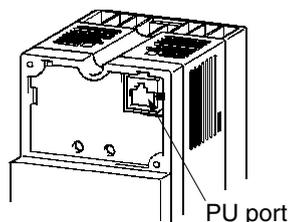

**A500 Series**  
Remove the operation panel.

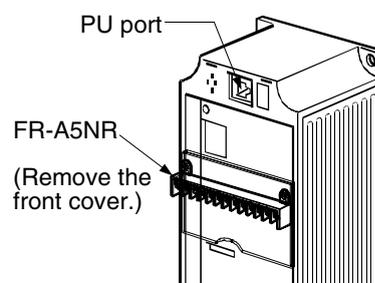

Model	Communication port	GOT connection destination	Parameters corresponding to inverter
A500 Series	Built in inverter	PU port	Pr117 to Pr124
	Option	FR-A5NR computer link option	Pr331 to Pr342
E500 Series	Built in inverter	PU port	Pr117 to Pr124
S500 Series	Built in inverter (only in certain models)	RS-485 port	n1 to n12

## 2) Communication setting in inverter

Set the following parameters using the PU (parameter unit) to realize the communication specifications of the GOT-F900.

Though these parameters can be monitored from the GOT-F900, do not change them. If they are changed, communication with the GOT-F900 is disabled.

Parameter number				Communication parameter	Setting	
S500 (RS-485)	A500 (PU)	A500 (FR-A5NR)	E500 (PU)		Set value	Contents of setting
n1	Pr. 117	Pr. 331	Pr. 117	Inverter station number	00~31	10 inverters can be connected at maximum.
n2	Pr. 118	Pr. 332	Pr. 118	Communication speed	192	19200 bps
n3	Pr. 119	Pr. 333	Pr. 119	Stop bit length	10	Data length: 7 bits Stop bit: 1 bit
n4	Pr. 120	Pr. 334	Pr. 120	Parity check yes/no	1	0: No parity check 1: Odd parity 2: Even parity
n5	Pr. 121	Pr. 335	Pr. 121	Communication retry count	S500:— A500:9999 E500:9999	No abnormal stop
n6	Pr. 122	Pr. 336	Pr. 122	Communication check time interval	S500:999 A500:999 E500:999	Communication check stop
n7	Pr. 123	Pr. 337	Pr. 123	Waiting time setting	0	0ms
n11	Pr. 124	Pr. 341	Pr. 124	CR•E LF yes/no selection	1	CR: Provided, LF: Not provided
Pr.79	Pr. 79	Pr. 79	Pr. 79	Operation mode	0	External operation mode at power ON
n10	—	Pr. 340	—	Link start mode selection	1	Computer link
n12	Pr. 342	Pr. 342	—	E <sup>2</sup> PROM write selection	0	Write to RAM and EEPROM
—	—	—	Pr. 146	Frequency setting command selection	999	Volume disabled

### a) S500 Series

- Parameters n1 to n7 and n10 to n12 are set in the built-in parameter unit.
- When parameters are monitored from the GOT-F900, they correspond to parameters Pr. 331 to Pr. 337 and Pr. 340 to Pr. 342 respectively.

### 13.3.3 Inverter Connector Specifications

#### 1) Pin layout in the PU port

Pin number	Signal name	Remarks
1	GND (SG)	
2	(P5S)	Not used
3	RXD+ (RDA)	
4	TXD- (SDB)	
5	TXD+ (SDA)	
6	RXD- (RDB)	
7	GND (SG)	
8	(P5S)	Not used

When seen from the front of the inverter (receptacle side)

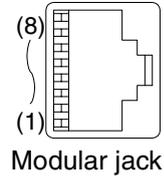

The contents inside ( ) indicate symbols described in the inverter manual. The pins number 2 and 8 (P5S) are connected to the power supply for an operation panel or a parameter unit. Do not use them in RS-422 communication.

#### 2) Terminal block layout in the FR-A5NR computer link option

Attach this option to the A500 Series.

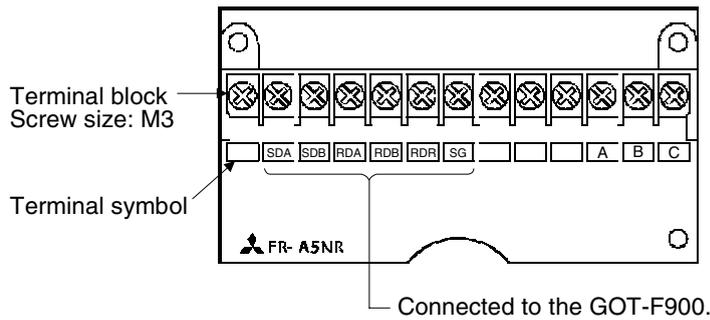

### 13.3.4 Specification of Station Number in Creating Screen

An inverter can be selected out of multiple units concurrently used by setting the station number under numerical setting in screen creation for GOT-F900.

The station number specified in the screen creation software corresponds to the station number specified for the parameter in an inverter.

There are a direct and an indirect methods to specify the station number when creating a screen.

If an individual screen is created for each inverter, it is a direct specification. Only one number corresponding to the inverter can be selected on one screen in order to edit its numerical value.

If one screen is created for selecting an unit out of multiple inverters to edit its value, it is an indirect specification. It is more effective in screen creation because the inverter of which the numerical value is to be changed can be selected on one screen using the GOT-F900 internal data register (GD).

#### 1) Direct specification

When setting the device, specify the station number of the inverter of which data is to be changed.  
Setting range: 0 to 31

#### 2) Indirect specification

When setting the device, indirectly specify the station number of the inverter of which data is to be changed using the 16-bit GOT internal data register (GD100 to GD115).

Setting range: 100 to 115 (Corresponds to each device from GD100 to GD115)

Setting example

Screen on GOT-F900

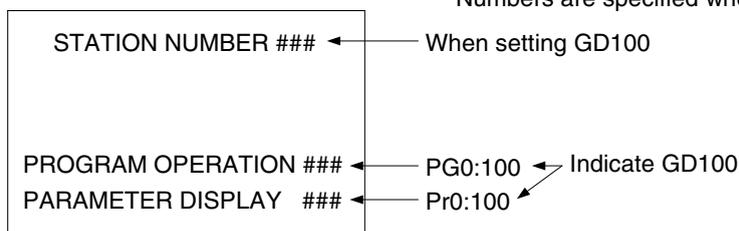

- Set the GOT internal data register (GD100) as the station number under numerical setting in the screen creation software. (Upper)
- Specify the device of the parameter in the inverter of which numerical value is to be displayed or edited as follows:  
PG0 (parameter) for Device, 100 for Station number (Middle)  
Pr0 (parameter) for Device, 100 for Station number (Lower)
- The parameter (PG0 and Pr0) of the inverter with the station number corresponding to GD100 is displayed.

## 13.4 Cautions on Use of FREQROL Series Inverter

When using the GOT-F900 connected to the FREQROL Series inverter, observe the following cautions on use.

### 13.4.1 Device specification

Devices correspond to parameters of the FREQROL Series inverter. Accordingly, the device range specifications vary depending on the model.

For the details of parameters, refer to section 13.6.

Device names and devices which can be monitored in GOT	a) Unsigned 16-bit	b) Screen changeover	c) System information/ control device	d) Status monitor	e) Time switch	f) Others
Control status (S)	–	–	–	△	–	✓
GOT internal bit register (GB)	–	–	✓	–	–	✓
Alarm code (A)	✓	–	–	–	–	–
Parameter (Pr)	✓	–	–	✓	–	✓
Program operation (PG)	✓	–	–	✓	–	✓
Special parameter (SP)	✓	–	–	✓	–	✓
GOT internal data register (GD)	✓	✓	✓	✓	–	✓

- Among word devices, only unsigned 16-bit numeric values can be used. GOT internal data registers (GD) are excluded.
- In screen changeover, GOT internal data registers (GD) can be specified.
- Only GOT internal data registers (GD) can be specified for the system information of the GT Designer. GOT internal bit registers (GB) and GOT internal data registers (GD) only can be specified for control devices of the DU/WIN.
- In the status monitoring function, the alarm code (A) device cannot be specified as the operation device (word SET).  
In the control status (S) device, only one operation (bit) device can be specified.
- Because the time switch cannot use the bit device control status (S), this function is not available.
- The alarm code (A) device cannot be specified in the following devices.
 

Recipe function	Write device of operation panel (word SET)
Bar code	Numeric input
ASCII input	Operation device of touch key (word SET)
Device for storing number of histories of alarm history	Device for storing number of occurrences of alarm list

### 13.4.2 Changeover from the GOT (communication) to the PU operation mode

- Not available in the S500 Series.
- Available in the E500 Series.
- Not available in the A500 Series if the GOT is connected to the communication board FR-A5NR.

### 13.4.3 When "8888" or "9999" is set to a parameter (Pr) of the inverter

Numbers "8888" and "9999" have special meaning respectively. When specifying such numbers from the GOT-F900, specify them as follows.

Set value on inverter side	Value to be specified in GOT-F900
8888	65520
9999	65535



### 13.4.4 Specification of the program operation (PG) devices

When setting the start time (PG10 to PG19, PG40 to PG49, PG70 to PG79), specify the hour or the minute to the upper 8 bits, and specify the minute or the second to the lower 8 bits.

Example: When setting "13:35"

Time to be specified	13 (hour)	35 (minute)	Remarks
Convert the hour and the minute to hexadecimal number respectively.	H0D	H23	Hexadecimal (HEX)
Add the upper bits and the lower bits.	Input "H0D23" or "3363".		

### 13.4.5 Caution on setting of the calibration parameters (Pr900 to Pr905)

When setting the calibration parameters (Pr900 to Pr905), the following value should be written to the second extension parameter (SP108) depending on the used device number and inverter model.

Value to be written to second extension parameter (SP108)	Description
H00	Offset/gain
H01	Analog
H02	Analog value of terminal

### 13.4.6 Restriction in simultaneous specification of PG and Pr devices on one screen

When creating a screen of the GOT-F900, specify either program operation (PG) device or parameter (Pr. 900 to Pr. 905) device. Do not specify both on one screen.

### 13.4.7 Caution on connecting to the PU port (only in the E500 and the A500)

When the power of the inverter is turned on, the external operation mode is automatically selected. In order to rewrite values of parameters, etc. in the GOT-F900, changing operation mode to "PU operation" in advance is required.

To change the operation mode, write "2" to the special parameter SP123.

11

Connection of  
MELSEC-Q  
Series PLC

12

Connection of  
FX Series  
Positioning

13

Connection of  
FREQROL  
Inverter

14

Connection of  
Microcom-  
puter

15

Connection of  
SYSMAC C  
Series PLC

16

Connection of  
FLEX-PC N  
Series PLC

17

Connection of  
Machine Con-  
troller

18

Connection of  
FP Series PLC

19

Connection of  
SLC500  
Series PLC

20

Connection of  
SIMATIC S7  
Series PLC



Device name in GOT-F900	Function of inverter																																																																																																											
Alarm code (A)	The contents of abnormalities number 1 to 8 in the inverter correspond to devices A0 to A7 in the GOT. (From the GOT-F900, only "Most recent No.1, No.2/alarm display clear" can be executed.) In the GOT-F900, abnormalities can be read only.																																																																																																											
	<table border="1"> <thead> <tr> <th data-bbox="422 418 590 486">Item</th> <th data-bbox="596 418 735 486">Instruction code</th> <th colspan="2" data-bbox="735 418 1455 486">Contents of data</th> </tr> </thead> <tbody> <tr> <td data-bbox="422 486 590 1644">Contents of abnormality (RD)</td> <td data-bbox="596 486 735 1644">H74 to H77</td> <td colspan="2" data-bbox="735 486 1455 1644"> <p>H0000 to HFFFF: Contents of two previous abnormalities                      Example of abnormality contents display (when the instruction code is "H74")                      Example: When the read data is "H30A0"</p> <table border="0" style="margin-left: auto; margin-right: auto;"> <tr> <td style="text-align: center;">b15</td> <td style="text-align: center;">b8</td> <td style="text-align: center;">b7</td> <td style="text-align: center;">b0</td> </tr> <tr> <td style="text-align: center;">0</td><td style="text-align: center;">0</td><td style="text-align: center;">1</td><td style="text-align: center;">1</td> </tr> <tr> <td style="text-align: center;">0</td><td style="text-align: center;">0</td><td style="text-align: center;">0</td><td style="text-align: center;">0</td> </tr> <tr> <td style="text-align: center;">0</td><td style="text-align: center;">1</td><td style="text-align: center;">0</td><td style="text-align: center;">1</td> </tr> <tr> <td style="text-align: center;">0</td><td style="text-align: center;">0</td><td style="text-align: center;">0</td><td style="text-align: center;">0</td> </tr> <tr> <td style="text-align: center;">0</td><td style="text-align: center;">0</td><td style="text-align: center;">0</td><td style="text-align: center;">0</td> </tr> </table> <p style="text-align: center;">                     Previous abnormality      Current abnormality  <u>Data (H30) = Contents (THT)</u>      <u>Data (HA0) = Contents (OPT)</u>                      Contents of abnormality      Contents of abnormality                      (Nos. 1, 3, 5, 7)      (Nos. 2, 4, 6, 8)                 </p> <p>Abnormality data correspondence table</p> <table border="1" style="width: 100%; border-collapse: collapse;"> <thead> <tr> <th>Data</th> <th>Contents</th> <th>Data</th> <th>Contents</th> </tr> </thead> <tbody> <tr><td>H00</td><td>No abnormality</td><td>HA0</td><td>OPT</td></tr> <tr><td>H10</td><td>0C1</td><td>HB0</td><td>PE</td></tr> <tr><td>H11</td><td>0C2</td><td>HB1</td><td>PUE</td></tr> <tr><td>H12</td><td>0C3</td><td>HB2</td><td>RET</td></tr> <tr><td>H20</td><td>0V1</td><td>HC0</td><td>CPU</td></tr> <tr><td>H21</td><td>0V2</td><td>HC1</td><td>CTE</td></tr> <tr><td>H22</td><td>0V3</td><td>HC2</td><td>P24</td></tr> <tr><td>H30</td><td>THT</td><td>HD5</td><td>MB1</td></tr> <tr><td>H31</td><td>THM</td><td>HD6</td><td>MB2</td></tr> <tr><td>H40</td><td>FIN</td><td>HD7</td><td>MB3</td></tr> <tr><td>H41</td><td>–</td><td>HD8</td><td>MB4</td></tr> <tr><td>H50</td><td>IPF</td><td>HD9</td><td>MB5</td></tr> <tr><td>H51</td><td>UVT</td><td>HDA</td><td>MB6</td></tr> <tr><td>H60</td><td>OLT</td><td>HDB</td><td>MB7</td></tr> <tr><td>H70</td><td>BE</td><td>HA1</td><td>OP1</td></tr> <tr><td>H80</td><td>GF</td><td>HA2</td><td>OP2</td></tr> <tr><td>H81</td><td>LF</td><td>HA3</td><td>OP3</td></tr> <tr><td>H90</td><td>OHT</td><td></td><td></td></tr> </tbody> </table> </td> </tr> </tbody> </table>	Item	Instruction code	Contents of data		Contents of abnormality (RD)	H74 to H77	<p>H0000 to HFFFF: Contents of two previous abnormalities                      Example of abnormality contents display (when the instruction code is "H74")                      Example: When the read data is "H30A0"</p> <table border="0" style="margin-left: auto; margin-right: auto;"> <tr> <td style="text-align: center;">b15</td> <td style="text-align: center;">b8</td> <td style="text-align: center;">b7</td> <td style="text-align: center;">b0</td> </tr> <tr> <td style="text-align: center;">0</td><td style="text-align: center;">0</td><td style="text-align: center;">1</td><td style="text-align: center;">1</td> </tr> <tr> <td style="text-align: center;">0</td><td style="text-align: center;">0</td><td style="text-align: center;">0</td><td style="text-align: center;">0</td> </tr> <tr> <td style="text-align: center;">0</td><td style="text-align: center;">1</td><td style="text-align: center;">0</td><td style="text-align: center;">1</td> </tr> <tr> <td style="text-align: center;">0</td><td style="text-align: center;">0</td><td style="text-align: center;">0</td><td style="text-align: center;">0</td> </tr> <tr> <td style="text-align: center;">0</td><td style="text-align: center;">0</td><td style="text-align: center;">0</td><td style="text-align: center;">0</td> </tr> </table> <p style="text-align: center;">                     Previous abnormality      Current abnormality  <u>Data (H30) = Contents (THT)</u>      <u>Data (HA0) = Contents (OPT)</u>                      Contents of abnormality      Contents of abnormality                      (Nos. 1, 3, 5, 7)      (Nos. 2, 4, 6, 8)                 </p> <p>Abnormality data correspondence table</p> <table border="1" style="width: 100%; border-collapse: collapse;"> <thead> <tr> <th>Data</th> <th>Contents</th> <th>Data</th> <th>Contents</th> </tr> </thead> <tbody> <tr><td>H00</td><td>No abnormality</td><td>HA0</td><td>OPT</td></tr> <tr><td>H10</td><td>0C1</td><td>HB0</td><td>PE</td></tr> <tr><td>H11</td><td>0C2</td><td>HB1</td><td>PUE</td></tr> <tr><td>H12</td><td>0C3</td><td>HB2</td><td>RET</td></tr> <tr><td>H20</td><td>0V1</td><td>HC0</td><td>CPU</td></tr> <tr><td>H21</td><td>0V2</td><td>HC1</td><td>CTE</td></tr> <tr><td>H22</td><td>0V3</td><td>HC2</td><td>P24</td></tr> <tr><td>H30</td><td>THT</td><td>HD5</td><td>MB1</td></tr> <tr><td>H31</td><td>THM</td><td>HD6</td><td>MB2</td></tr> <tr><td>H40</td><td>FIN</td><td>HD7</td><td>MB3</td></tr> <tr><td>H41</td><td>–</td><td>HD8</td><td>MB4</td></tr> <tr><td>H50</td><td>IPF</td><td>HD9</td><td>MB5</td></tr> <tr><td>H51</td><td>UVT</td><td>HDA</td><td>MB6</td></tr> <tr><td>H60</td><td>OLT</td><td>HDB</td><td>MB7</td></tr> <tr><td>H70</td><td>BE</td><td>HA1</td><td>OP1</td></tr> <tr><td>H80</td><td>GF</td><td>HA2</td><td>OP2</td></tr> <tr><td>H81</td><td>LF</td><td>HA3</td><td>OP3</td></tr> <tr><td>H90</td><td>OHT</td><td></td><td></td></tr> </tbody> </table>		b15	b8	b7	b0	0	0	1	1	0	0	0	0	0	1	0	1	0	0	0	0	0	0	0	0	Data	Contents	Data	Contents	H00	No abnormality	HA0	OPT	H10	0C1	HB0	PE	H11	0C2	HB1	PUE	H12	0C3	HB2	RET	H20	0V1	HC0	CPU	H21	0V2	HC1	CTE	H22	0V3	HC2	P24	H30	THT	HD5	MB1	H31	THM	HD6	MB2	H40	FIN	HD7	MB3	H41	–	HD8	MB4	H50	IPF	HD9	MB5	H51	UVT	HDA	MB6	H60	OLT	HDB	MB7	H70	BE	HA1	OP1	H80	GF	HA2	OP2	H81	LF	HA3	OP3	H90	OHT	
Item	Instruction code	Contents of data																																																																																																										
Contents of abnormality (RD)	H74 to H77	<p>H0000 to HFFFF: Contents of two previous abnormalities                      Example of abnormality contents display (when the instruction code is "H74")                      Example: When the read data is "H30A0"</p> <table border="0" style="margin-left: auto; margin-right: auto;"> <tr> <td style="text-align: center;">b15</td> <td style="text-align: center;">b8</td> <td style="text-align: center;">b7</td> <td style="text-align: center;">b0</td> </tr> <tr> <td style="text-align: center;">0</td><td style="text-align: center;">0</td><td style="text-align: center;">1</td><td style="text-align: center;">1</td> </tr> <tr> <td style="text-align: center;">0</td><td style="text-align: center;">0</td><td style="text-align: center;">0</td><td style="text-align: center;">0</td> </tr> <tr> <td style="text-align: center;">0</td><td style="text-align: center;">1</td><td style="text-align: center;">0</td><td style="text-align: center;">1</td> </tr> <tr> <td style="text-align: center;">0</td><td style="text-align: center;">0</td><td style="text-align: center;">0</td><td style="text-align: center;">0</td> </tr> <tr> <td style="text-align: center;">0</td><td style="text-align: center;">0</td><td style="text-align: center;">0</td><td style="text-align: center;">0</td> </tr> </table> <p style="text-align: center;">                     Previous abnormality      Current abnormality  <u>Data (H30) = Contents (THT)</u>      <u>Data (HA0) = Contents (OPT)</u>                      Contents of abnormality      Contents of abnormality                      (Nos. 1, 3, 5, 7)      (Nos. 2, 4, 6, 8)                 </p> <p>Abnormality data correspondence table</p> <table border="1" style="width: 100%; border-collapse: collapse;"> <thead> <tr> <th>Data</th> <th>Contents</th> <th>Data</th> <th>Contents</th> </tr> </thead> <tbody> <tr><td>H00</td><td>No abnormality</td><td>HA0</td><td>OPT</td></tr> <tr><td>H10</td><td>0C1</td><td>HB0</td><td>PE</td></tr> <tr><td>H11</td><td>0C2</td><td>HB1</td><td>PUE</td></tr> <tr><td>H12</td><td>0C3</td><td>HB2</td><td>RET</td></tr> <tr><td>H20</td><td>0V1</td><td>HC0</td><td>CPU</td></tr> <tr><td>H21</td><td>0V2</td><td>HC1</td><td>CTE</td></tr> <tr><td>H22</td><td>0V3</td><td>HC2</td><td>P24</td></tr> <tr><td>H30</td><td>THT</td><td>HD5</td><td>MB1</td></tr> <tr><td>H31</td><td>THM</td><td>HD6</td><td>MB2</td></tr> <tr><td>H40</td><td>FIN</td><td>HD7</td><td>MB3</td></tr> <tr><td>H41</td><td>–</td><td>HD8</td><td>MB4</td></tr> <tr><td>H50</td><td>IPF</td><td>HD9</td><td>MB5</td></tr> <tr><td>H51</td><td>UVT</td><td>HDA</td><td>MB6</td></tr> <tr><td>H60</td><td>OLT</td><td>HDB</td><td>MB7</td></tr> <tr><td>H70</td><td>BE</td><td>HA1</td><td>OP1</td></tr> <tr><td>H80</td><td>GF</td><td>HA2</td><td>OP2</td></tr> <tr><td>H81</td><td>LF</td><td>HA3</td><td>OP3</td></tr> <tr><td>H90</td><td>OHT</td><td></td><td></td></tr> </tbody> </table>		b15	b8	b7	b0	0	0	1	1	0	0	0	0	0	1	0	1	0	0	0	0	0	0	0	0	Data	Contents	Data	Contents	H00	No abnormality	HA0	OPT	H10	0C1	HB0	PE	H11	0C2	HB1	PUE	H12	0C3	HB2	RET	H20	0V1	HC0	CPU	H21	0V2	HC1	CTE	H22	0V3	HC2	P24	H30	THT	HD5	MB1	H31	THM	HD6	MB2	H40	FIN	HD7	MB3	H41	–	HD8	MB4	H50	IPF	HD9	MB5	H51	UVT	HDA	MB6	H60	OLT	HDB	MB7	H70	BE	HA1	OP1	H80	GF	HA2	OP2	H81	LF	HA3	OP3	H90	OHT							
b15	b8	b7	b0																																																																																																									
0	0	1	1																																																																																																									
0	0	0	0																																																																																																									
0	1	0	1																																																																																																									
0	0	0	0																																																																																																									
0	0	0	0																																																																																																									
Data	Contents	Data	Contents																																																																																																									
H00	No abnormality	HA0	OPT																																																																																																									
H10	0C1	HB0	PE																																																																																																									
H11	0C2	HB1	PUE																																																																																																									
H12	0C3	HB2	RET																																																																																																									
H20	0V1	HC0	CPU																																																																																																									
H21	0V2	HC1	CTE																																																																																																									
H22	0V3	HC2	P24																																																																																																									
H30	THT	HD5	MB1																																																																																																									
H31	THM	HD6	MB2																																																																																																									
H40	FIN	HD7	MB3																																																																																																									
H41	–	HD8	MB4																																																																																																									
H50	IPF	HD9	MB5																																																																																																									
H51	UVT	HDA	MB6																																																																																																									
H60	OLT	HDB	MB7																																																																																																									
H70	BE	HA1	OP1																																																																																																									
H80	GF	HA2	OP2																																																																																																									
H81	LF	HA3	OP3																																																																																																									
H90	OHT																																																																																																											
Parameter (Pr)	<p>Parameter devices in the GOT-F900 correspond to parameters in the inverter respectively. For the details of each parameter, refer to the manual of the inverter.</p> <p><b>Caution</b> Some parameters cannot be written or read.</p> <p>1) In the case of S500 Series                      - Pr. 37 cannot be read or written from the GOT.                      - When monitoring Pr. 10 or later, write "1" to Pr. 30.</p> <p>2) Parameter device range                      The ranges of Pr. 288 to Pr. 299, Pr. 343 to Pr. 899, Pr. 906 to Pr. 921 and Pr. 942 to Pr. 989 cannot be monitored from the GOT-F900.</p>																																																																																																											

11	Connection of MELSEC-Q Series PLC
12	Connection of FX Series Positioning
13	Connection of FREQROL Inverter
14	Connection of Microcomputer
15	Connection of SYMAC C Series PLC
16	Connection of FLEX-PC N Series PLC
17	Connection of Machine Controller
18	Connection of FP Series PLC
19	Connection of SLC500 Series PLC
20	Connection of SIMATIC S7 Series PLC

Device name in GOT-F900	Function of inverter																																																																									
Program operation (PG)	<p>(Only in the A500 Series)                      Parameters Pr. 201 to Pr. 230 in the inverter correspond to devices PG0 to PG89.</p> <p><b>1. Preparation</b>                      When using the program operation function, set Pr. 79 in the inverter to "5".                      Confirm "5. Related parameters" below in accordance with the contents of operation.</p> <p><b>2. Explanation</b>                      In the inverter, 30 parameters Pr. 201 to Pr. 230 are classified into 3 groups each of which consists of 10 parameters. The three types of contents, the time, the operation frequency and the rotation direction, are set to each parameter.                      In the GOT-F900, by monitoring PG0 to PG89, the contents of setting in Pr201 to Pr230 can be easily used without considering the instruction codes of the inverter (described below).</p> <table border="0" style="width: 100%; border-collapse: collapse;"> <tr> <td style="width: 15%;"></td> <td style="width: 15%; text-align: center; border-bottom: 1px solid black;">Setting point</td> <td style="width: 55%; text-align: center; border-bottom: 1px solid black;">Rotation direction, frequency, start time</td> <td style="width: 15%;"></td> </tr> <tr> <td rowspan="10" style="vertical-align: middle; font-size: 2em;">{</td> <td style="text-align: center;">No.1</td> <td style="text-align: center;">Pr.201</td> <td rowspan="10" style="vertical-align: middle; font-size: 2em;">}</td> </tr> <tr> <td style="text-align: center;">2</td> <td style="text-align: center;">Pr.202</td> </tr> <tr> <td style="text-align: center;">3</td> <td style="text-align: center;">Pr.203</td> </tr> <tr> <td style="text-align: center;">4</td> <td style="text-align: center;">Pr.204</td> </tr> <tr> <td style="text-align: center;">.</td> <td style="text-align: center;">.</td> </tr> <tr> <td style="text-align: center;">.</td> <td style="text-align: center;">.</td> </tr> <tr> <td style="text-align: center;">.</td> <td style="text-align: center;">.</td> </tr> <tr> <td style="text-align: center;">.</td> <td style="text-align: center;">.</td> </tr> <tr> <td style="text-align: center;">10</td> <td style="text-align: center;">Pr.210</td> </tr> <tr> <td style="text-align: center;">10</td> <td style="text-align: center;">Pr.210</td> <td style="text-align: center;">Correspond to PG0 to PG29.</td> </tr> <tr> <td rowspan="10" style="vertical-align: middle; font-size: 2em;">{</td> <td style="text-align: center;">No.11</td> <td style="text-align: center;">Pr.211</td> <td rowspan="10" style="vertical-align: middle; font-size: 2em;">}</td> </tr> <tr> <td style="text-align: center;">.</td> <td style="text-align: center;">.</td> </tr> <tr> <td style="text-align: center;">.</td> <td style="text-align: center;">.</td> </tr> <tr> <td style="text-align: center;">.</td> <td style="text-align: center;">.</td> </tr> <tr> <td style="text-align: center;">.</td> <td style="text-align: center;">.</td> </tr> <tr> <td style="text-align: center;">.</td> <td style="text-align: center;">.</td> </tr> <tr> <td style="text-align: center;">.</td> <td style="text-align: center;">.</td> </tr> <tr> <td style="text-align: center;">.</td> <td style="text-align: center;">.</td> </tr> <tr> <td style="text-align: center;">20</td> <td style="text-align: center;">Pr.220</td> </tr> <tr> <td style="text-align: center;">20</td> <td style="text-align: center;">Pr.220</td> <td style="text-align: center;">Correspond to PG30 to PG59.</td> </tr> <tr> <td rowspan="10" style="vertical-align: middle; font-size: 2em;">{</td> <td style="text-align: center;">No.21</td> <td style="text-align: center;">Pr.221</td> <td rowspan="10" style="vertical-align: middle; font-size: 2em;">}</td> </tr> <tr> <td style="text-align: center;">.</td> <td style="text-align: center;">.</td> </tr> <tr> <td style="text-align: center;">.</td> <td style="text-align: center;">.</td> </tr> <tr> <td style="text-align: center;">.</td> <td style="text-align: center;">.</td> </tr> <tr> <td style="text-align: center;">.</td> <td style="text-align: center;">.</td> </tr> <tr> <td style="text-align: center;">.</td> <td style="text-align: center;">.</td> </tr> <tr> <td style="text-align: center;">.</td> <td style="text-align: center;">.</td> </tr> <tr> <td style="text-align: center;">.</td> <td style="text-align: center;">.</td> </tr> <tr> <td style="text-align: center;">30</td> <td style="text-align: center;">Pr.230</td> </tr> <tr> <td style="text-align: center;">30</td> <td style="text-align: center;">Pr.230</td> <td style="text-align: center;">Correspond to PG60 to PG89.</td> </tr> </table>		Setting point	Rotation direction, frequency, start time		{	No.1	Pr.201	}	2	Pr.202	3	Pr.203	4	Pr.204	.	.	.	.	.	.	.	.	10	Pr.210	10	Pr.210	Correspond to PG0 to PG29.	{	No.11	Pr.211	}	.	.	.	.	.	.	.	.	.	.	.	.	.	.	20	Pr.220	20	Pr.220	Correspond to PG30 to PG59.	{	No.21	Pr.221	}	.	.	.	.	.	.	.	.	.	.	.	.	.	.	30	Pr.230	30	Pr.230	Correspond to PG60 to PG89.
		Setting point	Rotation direction, frequency, start time																																																																							
	{	No.1	Pr.201	}																																																																						
2		Pr.202																																																																								
3		Pr.203																																																																								
4		Pr.204																																																																								
.		.																																																																								
.		.																																																																								
.		.																																																																								
.		.																																																																								
10		Pr.210																																																																								
10		Pr.210	Correspond to PG0 to PG29.																																																																							
{	No.11	Pr.211	}																																																																							
	.	.																																																																								
	.	.																																																																								
	.	.																																																																								
	.	.																																																																								
	.	.																																																																								
	.	.																																																																								
	.	.																																																																								
	20	Pr.220																																																																								
	20	Pr.220		Correspond to PG30 to PG59.																																																																						
{	No.21	Pr.221	}																																																																							
	.	.																																																																								
	.	.																																																																								
	.	.																																																																								
	.	.																																																																								
	.	.																																																																								
	.	.																																																																								
	.	.																																																																								
	30	Pr.230																																																																								
	30	Pr.230		Correspond to PG60 to PG89.																																																																						
<p><b>3. Correspondence table between device PG and set value of each parameter</b></p> <table border="1" style="width: 100%; border-collapse: collapse; text-align: center;"> <thead> <tr> <th rowspan="2" style="width: 30%;">Parameter number for inverter</th> <th colspan="3">Device in GOT-F900</th> </tr> <tr> <th style="width: 20%;">Operation frequency</th> <th style="width: 20%;">Start time</th> <th style="width: 30%;">Rotation direction</th> </tr> </thead> <tbody> <tr> <td>Pr. 201 to Pr. 210 (Group 1)</td> <td>PG0 to PG9</td> <td>PG10 to PG19</td> <td>PG20 to PG29</td> </tr> <tr> <td>Pr. 211 to Pr. 220 (Group 2)</td> <td>PG30 to PG39</td> <td>PG40 to PG49</td> <td>PG50 to PG59</td> </tr> <tr> <td>Pr. 221 to Pr. 230 (Group 3)</td> <td>PG60 to PG69</td> <td>PG70 to PG79</td> <td>PG80 to PG89</td> </tr> </tbody> </table>	Parameter number for inverter	Device in GOT-F900			Operation frequency	Start time	Rotation direction	Pr. 201 to Pr. 210 (Group 1)	PG0 to PG9	PG10 to PG19	PG20 to PG29	Pr. 211 to Pr. 220 (Group 2)	PG30 to PG39	PG40 to PG49	PG50 to PG59	Pr. 221 to Pr. 230 (Group 3)	PG60 to PG69	PG70 to PG79	PG80 to PG89																																																							
Parameter number for inverter		Device in GOT-F900																																																																								
	Operation frequency	Start time	Rotation direction																																																																							
Pr. 201 to Pr. 210 (Group 1)	PG0 to PG9	PG10 to PG19	PG20 to PG29																																																																							
Pr. 211 to Pr. 220 (Group 2)	PG30 to PG39	PG40 to PG49	PG50 to PG59																																																																							
Pr. 221 to Pr. 230 (Group 3)	PG60 to PG69	PG70 to PG79	PG80 to PG89																																																																							

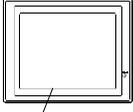
Device name in GOT-F900	Function of inverter																		
<p>Program operation (PG)</p>	<p><b>4. Contents of communication in the GOT-F900 (reference)</b>                      When the PG device is monitored in the GOT-F900, the instruction codes are issued and communication is executed.                      The instruction codes are automatically issued in the following procedure, and the user does not have to consider it.</p> <p style="text-align: center;">Procedure for communication with inverter <span style="float: right;">Station number 5</span></p> <div style="display: flex; justify-content: space-around; align-items: center;"> <div style="text-align: center;">  <p>PG0 is set in numeric display.</p> </div> <div style="text-align: center;"> <p>← PG0 is read.</p> <p>→ Instruction codes (1)FF (2)6C (3)3D</p> </div> <div style="text-align: center;">  </div> </div> <p>(1) Writes the link parameter extension setting (H01) to SP127 by communication</p> <table border="1" style="margin-left: auto; margin-right: auto;"> <tr> <td>ENQ</td> <td>Station H5</td> <td>Instruction codes HFF</td> <td>Data H01</td> <td>Sum check</td> <td>CR</td> </tr> </table> <p>(2) Writes the second parameter changeover (H02) to SP108 (changeover to the rotation direction), then transfers it.</p> <table border="1" style="margin-left: auto; margin-right: auto;"> <tr> <td>ENQ</td> <td>Station H5</td> <td>Instruction codes H6C</td> <td>Data H02</td> <td>Sum check</td> <td>CR</td> </tr> </table> <p>(3) Pr201 is read.</p> <table border="1" style="margin-left: auto; margin-right: auto;"> <tr> <td>ENQ</td> <td>Station H5</td> <td>Instruction codes H3D</td> <td>Data H01</td> <td>Sum check</td> <td>CR</td> </tr> </table> <p>The link parameter extension setting and the second parameter changeover are instruction codes in communication.</p> <p><b>5. Related parameters</b>                      Set the following parameters to desired values.                      Pr. 200: Time unit in program (Select "minute and second" or "hour and minute.")                      Pr. 231: Time setting (Set the time used as the reference of program operation.)</p>	ENQ	Station H5	Instruction codes HFF	Data H01	Sum check	CR	ENQ	Station H5	Instruction codes H6C	Data H02	Sum check	CR	ENQ	Station H5	Instruction codes H3D	Data H01	Sum check	CR
ENQ	Station H5	Instruction codes HFF	Data H01	Sum check	CR														
ENQ	Station H5	Instruction codes H6C	Data H02	Sum check	CR														
ENQ	Station H5	Instruction codes H3D	Data H01	Sum check	CR														

- 11 Connection of MELSEC-Q Series PLC
- 12 Connection of FX Series Positioning
- 13 Connection of FREQROL Inverter
- 14 Connection of Microcomputer
- 15 Connection of SYSMAC C Series PLC
- 16 Connection of FLEX-PC N Series PLC
- 17 Connection of Machine Controller
- 18 Connection of FP Series PLC
- 19 Connection of SLC500 Series PLC
- 20 Connection of SIMATIC S7 Series PLC

Device name in GOT-F900	Function of inverter				
Special parameter (SP)	This communication function of the inverter can be executed using the instruction code number. When an instruction code is written to the special parameter (SP) device in the GOT-F900, communication with the inverter is executed.				
	Device in GOT	Instruction code		Description	Corresponding device in GOT
		Read	Write		
	SP108	6C	EC	Second parameter changeover switch-over	PG,Pr
	SP109	6D	ED	Running frequency (RAM)	
	SP110	6E	EE	Running frequency (E <sup>2</sup> PROM)	
	SP111	6F	-	Frequency monitor	
	SP112	70	-	Output current monitor	
	SP113	71	-	Output voltage monitor	
	SP114	72	-	Special monitor	
	SP115	73	F3	Special monitor selection No.	
	SP116	74	F4	Most recent No.1, No.2/alarm display clear	A
	SP117	75	-	Most recent No.3, No.4/alarm display clear	A
	SP118	76	-	Most recent No.5, No.6/alarm display clear	A
	SP119	77	-	Most recent No.7, No.8/alarm display clear	A
	SP122	7A	FA	Inverter status monitor/run command	S
	SP123	7B	FB	Operation mode acquisition	
	SP124	-	FC	All clear	
SP125	-	FD	Inverter reset		
SP127	7F	FF	Link parameter extension setting	S,A,PG,PR	
SP124 and SP125 can execute write only. SP111 to SP114 can execute monitoring only.					
<b>Caution</b>					
In the case of E500/S500 Series:					
When SP127 is 1 and Pr37 is not 0, SP109 to SP111 cannot execute monitoring (write/read).					

## 13.6 FREQROL Inverter Parameter List

This section describes, for reference, the list of comparison of parameters in the FREQROL Series inverters S500, E500 and A500.

For the details of each function, refer to the manual of the inverter respectively.

### 13.6.1 Parameters

The inverter is equipped with the following parameters.

(For the details, make sure to refer to the manual of the inverter.)

Function	A500		E500		S500	
	Pr	Name	Pr	Name	Pr	Name
Basic functions	0	Torque boost	0	Torque boost	0	Torque boost
	1	Maximum frequency	1	Maximum frequency	1	Maximum frequency
	2	Minimum frequency	2	Minimum frequency	2	Minimum frequency
	3	Base frequency	3	Base frequency	3	Base frequency
	4	Multi-speed setting (high speed)	4	Multi-speed setting (high speed)	4	Multi-speed setting (high speed)
	5	Multi-speed setting (middle speed)	5	Multi-speed setting (middle speed)	5	Multi-speed setting (middle speed)
	6	Multi-speed setting (low speed)	6	Multi-speed setting (low speed)	6	Multi-speed setting (low speed)
	7	Acceleration time	7	Acceleration time	7	Acceleration time
	8	Deceleration time	8	Deceleration time	8	Deceleration time
Standard operation functions	9	Electronic thermal O/L relay	9	Electronic thermal O/L relay	9	Electronic thermal O/L relay
	10	DC injection brake operation frequency	10	DC injection brake operation frequency	10	DC injection brake operation frequency
	11	DC injection brake operation time	11	DC injection brake operation time	11	DC injection brake operation time
	12	DC injection brake voltage	12	DC injection brake voltage	12	DC injection brake voltage
	13	Starting frequency	13	Starting frequency	13	Starting frequency
	14	Load pattern selection	14	Load pattern selection	14	Load pattern selection
	15	Jog frequency	15	Jog frequency	15	Jog frequency
	16	Jog acceleration/deceleration time	16	Jog acceleration/deceleration time	16	Jog acceleration/deceleration time
	17	MRS input selection	–	–	17	RUN key rotation direction selection
	18	High-speed maximum frequency	18	High-speed maximum frequency	–	–
	19	Base frequency voltage	19	Base frequency voltage	19	Base frequency voltage
	20	Acceleration/deceleration reference frequency	20	Acceleration/deceleration reference frequency	20	Acceleration/deceleration reference frequency
	21	Acceleration/deceleration time increments	21	Acceleration/deceleration time increments	21	Acceleration/deceleration time increments
	22	Stall prevention operation level	22	Stall prevention operation level	22	Stall prevention operation level
	23	Stall prevention operation level compensation factor at double speed	23	Stall prevention operation level compensation factor at double speed	23	Stall prevention operation level compensation factor at double speed
	24	Multi-speed setting (speed 4)	24	Multi-speed setting (speed 4)	24	Multi-speed setting (speed 4)
	25	Multi-speed setting (speed 5)	25	Multi-speed setting (speed 5)	25	Multi-speed setting (speed 5)
	26	Multi-speed setting (speed 6)	26	Multi-speed setting (speed 6)	26	Multi-speed setting (speed 6)
	27	Multi-speed setting (speed 7)	27	Multi-speed setting (speed 7)	27	Multi-speed setting (speed 7)
	28	Multi-speed input compensation	–	–	28	Stall prevention operation reduction starting frequency
	29	Acceleration/deceleration pattern	29	Acceleration/deceleration pattern	29	Acceleration/deceleration pattern
	30	Regenerative function selection	30	Regenerative function selection	30	Regenerative function selection
	31	Frequency jump 1A	31	Frequency jump 1A	31	Frequency jump 1A
	32	Frequency jump 1B	32	Frequency jump 1B	32	Frequency jump 1B
	33	Frequency jump 2A	33	Frequency jump 2A	33	Frequency jump 2A
	34	Frequency jump 2B	34	Frequency jump 2B	34	Frequency jump 2B
	35	Frequency jump 3A	35	Frequency jump 3A	35	Frequency jump 3A
	36	Frequency jump 3B	36	Frequency jump 3B	36	Frequency jump 3B
	37	Speed display	37	Speed display	37	Speed display
	–	–	38	Frequency at 5V (10V) input	38	Frequency setting voltage gain frequency
–	–	39	Frequency at 20mA input	39	Frequency setting current gain frequency	
–	–	–	–	40	Start-time ground fault detection selection	
Output terminal functions	41	Up-to-frequency sensitivity	41	Up-to-frequency sensitivity	41	Up-to-frequency sensitivity
	42	Output frequency detection	42	Output frequency detection	42	Output frequency detection
	43	Output frequency detection for reverse rotation	43	Output frequency detection for reverse rotation	43	Output frequency detection for reverse rotation

Function	A500		E500		S500	
	Pr	Name	Pr	Name	Pr	Name
Second functions	44	Second acceleration/deceleration time	44	Second acceleration/deceleration time	44	Second acceleration/deceleration time
	45	Second deceleration time	45	Second deceleration time	45	Second deceleration time
	46	Second torque boost	46	Second torque boost	46	Second torque boost
	47	Second V/F (base frequency)	47	Second V/F (base frequency)	47	Second V/F(base frequency)
	48	Second stall prevention operation current	48	Second stall prevention operation current	-	-
	49	Second stall prevention operation frequency	-	-	-	-
	50	Second output frequency detection	-	-	-	-
Display functions	52	DU/PU main display data selection	52	Control panel/PU main display data selection 34 B4 0	52	Control panel display data selection
	53	PU level display data selection	-	-	53	Frequency setting operation selection
	54	FM terminal function selection	54	FM terminal function selection	54	FM terminal function selection
	55	Frequency monitoring reference	55	Frequency monitoring reference	55	Frequency monitoring reference
	56	Current monitoring reference	56	Current monitoring reference	56	Current monitoring reference
Rated output current	57	Restart coasting time	57	Restart coasting time	57	Restart coasting time
	58	Restart cushion time	58	Restart cushion time	58	Restart cushion time
Additional function	59	Remote setting function selection	59	Remote setting function selection	59	Remote setting function selection
Operation selection functions	60	Intelligent mode selection	60	Shortest acceleration/deceleration mode 3C BC 0	-	-
	61	Reference I for intelligent mode	61	Reference I for intelligent mode	-	-
	62	Ref. I for intelligent mode accel	62	Ref. I for intelligent mode accel	-	-
	63	Ref. I for intelligent mode decel	63	Ref. I for intelligent mode decel	-	-
	64	Starting frequency for elevator mode	64	Starting frequency for elevator mode	-	-
	65	Retry selection	65	Retry selection	-	-
	66	Stall prevention operation level reduction starting frequency	66	Stall prevention operation level reduction starting frequency	66	Retry selection
	67	Number of retries at alarm occurrence	67	Number of retries at alarm occurrence	67	Number of retries at alarm occurrence
	68	Retry waiting time	68	Retry waiting time	68	Retry waiting time
	69	Retry count display erasure	69	Retry count display erasure	69	Retry count display erasure
	70	Special regenerative brake duty	70	Special regenerative brake duty	-	-
	71	Applied motor	71	Applied motor	71	Applied motor
	72	PWM frequency selection	72	PWM frequency selection	72	PWM frequency selection
	73	0-5V/0-10V selection	73	0-5V/0-10V selection	73	0-5V/0-10V selection
	74	Filter time constant	74	Filter time constant	74	Input filter time constant
	75	Reset selection/disconnected PU detection/PU stop selection	75	Reset selection/disconnected PU detection/PU stop selection	75	Reset selection/PU stop selection
	76	Alarm code output selection	76	Alarm code output selection	76	Cooling fan operation selection
77	Parameter write disable selection	77	Parameter write disable selection	77	Parameter write disable selection	
78	Reverse rotation prevention selection	78	Reverse rotation prevention selection	78	Reverse rotation prevention selection	
79	Operation mode selection	79	Operation mode selection	79	Operation mode selection	
Advanced magnetic flux vector control	80	Motor capacity	80	Motor capacity	-	-
	81	Number of motor poles	81	Number of motor poles	-	-
	82	Motor exciting current	82	Motor exciting current	-	-
	83	Rated motor voltage	83	Rated motor voltage	-	-
	84	Rated motor frequency	84	Rated motor frequency	-	-
	89	Speed control gain	-	-	-	-
	90	Motor constant (R1)	90	Motor constant (R1)	-	-
	91	Motor constant (R2)	-	-	-	-
	92	Motor constant (L1)	-	-	-	-
	93	Motor constant (L2)	-	-	-	-
	94	Motor constant (X)	-	-	-	-
95	Online auto tuning selection	-	-	-	-	
96	Auto-tuning setting/status	96	Auto-tuning setting/status	-	-	
-	-	-	-	-	-	



Function	A500		E500		S500	
	Pr	Name	Pr	Name	Pr	Name
5-point flexible V/F characteristics	100	V/F1 (first frequency)	-	-	-	-
	101	V/F1 (first frequency voltage)	-	-	-	-
	102	V/F2 (second frequency)	-	-	-	-
	103	V/F2 (second frequency voltage)	-	-	-	-
	104	V/F3 (third frequency)	-	-	-	-
	105	V/F3 (third frequency voltage)	-	-	-	-
	106	V/F4 (fourth frequency)	-	-	-	-
	107	V/F4 (fourth frequency voltage)	-	-	-	-
	108	V/F5 (fifth frequency)	-	-	-	-
Third functions	109	V/F5 (fifth frequency voltage)	-	-	-	-
	110	Third acceleration/deceleration time	-	-	-	-
	111	Third deceleration time	-	-	-	-
	112	Third torque boost	-	-	-	-
	113	Third V/F (base frequency)	-	-	-	-
	114	Third stall prevention operation current	-	-	-	-
	115	Third stall prevention operation frequency	-	-	-	-
Communication functions	116	Third output frequency detection	-	-	-	-
	117	Station number	117	Station number	-	-
	118	Communication speed	118	Communication speed	-	-
	119	Stop bit length	119	Stop bit length	-	-
	120	Parity check presence/absence	120	Parity check presence/absence	-	-
	121	Number of communication retries	121	Number of communication retries	-	-
	122	Communication check time interval	122	Communication check time interval	-	-
	123	Waiting time setting	123	Waiting time setting	-	-
PID control	124	CR, LF presence/absence selection	124	CR, LF presence/absence selection	-	-
	128	PID action selection	128	PID action selection	88	PID action selection
	129	PID proportional band	129	PID proportional band	89	PID proportional band
	130	PID integral time	130	PID integral time	90	PID integral time
	131	Upper limit	131	Upper limit	91	Upper limit
	132	Lower limit	132	Lower limit	92	Lower limit
	133	PID action set point for PU operation	133	PID action set point for PU operation	93	PID action set point for PU operation
Commercial power supply-inverter switch-over	134	PID differential time	134	PID differential time	94	PID differential time
	135	Commercial power supply-inverter switch-over sequence output terminal selection	-	-	-	-
	136	MC switch-over interlock time	-	-	-	-
	137	Start waiting time	-	-	-	-
	138	Commercial power supply-inverter switch-over selection at alarm occurrence	-	-	-	-
Backlash	139	Automatic inverter-commercial power supply switch-over frequency	-	-	-	-
	140	Backlash acceleration stopping frequency	-	-	-	-
	141	Backlash acceleration stopping time	-	-	-	-
	142	Backlash deceleration stopping frequency	-	-	-	-
Display	143	Backlash deceleration stopping time	-	-	-	-
	144	Speed setting switch-over	-	-	-	-
Additional functions	145	Parameter unit language switch-over	145	Parameter unit language switch-over	-	-
	148	Stall prevention operation level at 0V input	146	Frequency setting command selection	-	-
Current detection	149	Stall prevention operation level at 10V input	-	-	-	-
	150	Output current detection level	150	Output current detection level	48	Output current detection level
	151	Output current detection period	151	Output current detection period	49	Output current detection period
	152	Zero current detection time	152	Zero current detection time	50	Zero current detection time
	153	Zero current detection period	153	Zero current detection period	51	Zero current detection period

11	Connection of MELSEC-Q Series PLC
12	Connection of FX Series Positioning
13	Connection of FREQROL Inverter
14	Connection of Microcomputer
15	Connection of SYSMAC C Series PLC
16	Connection of FLEX-PC N Series PLC
17	Connection of Machine Controller
18	Connection of FP Series PLC
19	Connection of SLC500 Series PLC
20	Connection of SIMATIC S7 Series PLC

Function	A500		E500		S500	
	Pr	Name	Pr	Name	Pr	Name
Sub functions	154	Voltage reduction selection during stall prevention operation	-	-	-	-
	155	RT signal activated condition	-	-	-	-
	156	Stall prevention operation selection	156	Stall prevention operation selection	-	-
	157	OL signal waiting time	-	-	-	-
	158	AM terminal function selection	-	-	-	-
Additional function	160	User group read selection	160	User group read selection	-	-
Restart after instantaneous power failure	162	Automatic restart after instantaneous power failure selection	-	-	-	-
	163	First cushion time for restart	-	-	-	-
	164	First cushion voltage for restart	-	-	-	-
	165	Restart stall prevention operation level	-	-	-	-
Initial monitor	170	Watt-hour meter clear	-	-	-	-
	171	Actual operation hour meter clear	171	Actual operation hour meter clear	-	-
User functions	173	User group 1 registration	173	User group 1 registration	-	-
	174	User group 1 deletion	174	User group 1 deletion	-	-
	175	User group 2 registration	175	User group 2 registration	-	-
	176	User group 2 deletion	176	User group 2 deletion	-	-
Terminal assignment functions	180	RL terminal function selection	180	RL terminal function selection	60	RL terminal function selection
	181	RM terminal function selection	181	RM terminal function selection	61	RM terminal function selection
	182	RH terminal function selection	182	RH terminal function selection	62	RH terminal function selection
	183	RT terminal function selection	183	MRS terminal function selection	63	SRT terminal function selection
	184	AU terminal function selection	-	-	-	-
	185	JOG terminal function selection	-	-	-	-
	186	CS terminal function selection	-	-	-	-
	190	RUN terminal function selection	190	RUN terminal function selection	64	RUN terminal function selection
	191	SU terminal function selection	191	SU terminal function selection	-	-
	192	IPF terminal function selection	192	A, B, C terminal function selection	-	-
	193	OL terminal function selection	-	-	-	-
194	FU terminal function selection	-	-	-	-	
195	A, B, C terminal function selection	-	-	65	A, B, C terminal function selection	
Additional function	199	User's initial value setting	-	-	-	-

Function	A500		E500		S500	
	Pr	Name	Pr	Name	Pr	Name
Programmed operation	200	Programmed operation minute/second selection	-	-	-	-
	201	Program setting 1	-	-	-	-
	202	Program setting 1	-	-	-	-
	203	Program setting 1	-	-	-	-
	204	Program setting 1	-	-	-	-
	205	Program setting 1	-	-	-	-
	206	Program setting 1	-	-	-	-
	207	Program setting 1	-	-	-	-
	208	Program setting 1	-	-	-	-
	209	Program setting 1	-	-	-	-
	210	Program setting 1	-	-	-	-
	211	Program setting 2	-	-	-	-
	212	Program setting 2	-	-	-	-
	213	Program setting 2	-	-	-	-
	214	Program setting 2	-	-	-	-
	215	Program setting 2	-	-	-	-
	216	Program setting 2	-	-	-	-
	217	Program setting 2	-	-	-	-
	218	Program setting 2	-	-	-	-
	219	Program setting 2	-	-	-	-
	220	Program setting 2	-	-	-	-
	221	Program setting 3	-	-	-	-
	222	Program setting 3	-	-	-	-
223	Program setting 3	-	-	-	-	
224	Program setting 3	-	-	-	-	
225	Program setting 3	-	-	-	-	
226	Program setting 3	-	-	-	-	
227	Program setting 3	-	-	-	-	
228	Program setting 3	-	-	-	-	
229	Program setting 3	-	-	-	-	
230	Program setting 3	-	-	-	-	
231	Timer setting	-	-	-	-	
Multi-speed operation	232	Multi-speed setting (speed 8)	232	Multi-speed setting (speed 8)	80	Multi-speed setting (speed 8)
	233	Multi-speed setting (speed 9)	233	Multi-speed setting (speed 9)	81	Multi-speed setting (speed 9)
	234	Multi-speed setting (speed 10)	234	Multi-speed setting (speed 10)	82	Multi-speed setting (speed 10)
	235	Multi-speed setting (speed 11)	235	Multi-speed setting (speed 11)	83	Multi-speed setting (speed 11)
	236	Multi-speed setting (speed 12)	236	Multi-speed setting (speed 12)	84	Multi-speed setting (speed 12)
	237	Multi-speed setting (speed 13)	237	Multi-speed setting (speed 13)	85	Multi-speed setting (speed 13)
	238	Multi-speed setting (speed 14)	238	Multi-speed setting (speed 14)	86	Multi-speed setting (speed 14)
239	Multi-speed setting (speed 15)	239	Multi-speed setting (speed 15)	87	Multi-speed setting (speed 15)	
Sub functions	240	Soft-PWM setting	240	Soft-PWM setting	70	Soft-PWM setting
	244	Cooling fan operation selection	244	Cooling fan operation selection	-	-
	-	-	245	Rated motor slip	95	Rated motor slip
	-	-	246	Slip compensation time constant	96	Slip compensation time constant
	-	-	247	Constant-output region slip compensation selection	97	Constant-output region slip compensation selection
	-	-	-	-	98	Automatic torque boost selection (Motor capacity)
-	-	249	Motor primary resistance	99	Motor primary resistance	
Stop selection function	250	Stop selection	250	Stop selection	-	-
Additional function	251	Output phase failure protection selection	251	Output phase failure protection selection	-	-
	252	Override bias	-	-	-	-
	253	Override gain	-	-	-	-

11 Connection of MELSEC-Q Series PLC  
 12 Connection of FX Series Positioning  
 13 Connection of FREQROL Inverter  
 14 Connection of Microcomputer  
 15 Connection of SYSMAC C Series PLC  
 16 Connection of FLEX-PC N Series PLC  
 17 Connection of Machine Controller  
 18 Connection of FP Series PLC  
 19 Connection of SLC500 Series PLC  
 20 Connection of SIMATIC S7 Series PLC

Function	A500		E500		S500	
	Pr	Name	Pr	Name	Pr	Name
Power failure stop functions	261	Power failure stop selection	-	-	-	-
	262	Subtracted frequency at deceleration start	-	-	-	-
	263	Subtraction starting frequency	-	-	-	-
	264	Power-failure deceleration time 1	-	-	-	-
	265	Power-failure deceleration time 2	-	-	-	-
	266	Power-failure deceleration time switch-over frequency	-	-	-	-
Function selection	270	Stop-on-contact/load torque high-speed frequency control selection	-	-	-	-
High speed frequency control	271	High-speed setting maximum current	-	-	-	-
	272	Mid-speed setting minimum current	-	-	-	-
	273	Current averaging range	-	-	-	-
	274	Current averaging filter constant	-	-	-	-
Stop on contact	275	Stop-on-contact exciting current low-speed multiplying factor	-	-	-	-
	276	Stop-on-contact PWM carrier frequency	-	-	-	-
Brake sequence functions	278	Brake opening frequency	-	-	-	-
	279	Brake opening current	-	-	-	-
	280	Brake opening current detection time	-	-	-	-
	281	Brake operation time at start	-	-	-	-
	282	Brake operation frequency	-	-	-	-
	283	Brake operation time at stop	-	-	-	-
	284	Deceleration detection function selection	-	-	-	-
	285	Overspeed detection frequency	-	-	-	-
Droop control	286	Droop gain	-	-	-	-
	287	Droop filter constant	-	-	-	-
Additional function	342	E <sup>2</sup> PROM write selection	342	E <sup>2</sup> PROM write selection	n12 342	E <sup>2</sup> PROM write selection
Calibration functions	900	FM (AM) terminal calibration	900	FM (AM) terminal calibration	C1 900	FM (AM) terminal calibration
	901	AM terminal calibration	-	-	-	-
	902	Frequency setting voltage bias	902	Frequency setting voltage bias	C2 902	Frequency setting voltage bias frequency
					C3 902	Frequency setting voltage bias
	903	Frequency setting voltage gain	903	Frequency setting voltage gain	C4 903	Frequency setting voltage gain
	904	Frequency setting current bias	904	Frequency setting current bias	C6 904	Frequency setting current bias frequency
	905	Frequency setting current gain	905	Frequency setting current gain	C7 905	Frequency setting current bias
	-	Built-in frequency setting	-	-	-	Parameter set by manufacturer. Do not set.
	-	-	922	Built-in frequency setting potentiometer bias	-	-
-	-	923	Built-in frequency setting potentiometer gain	-	-	
Additional function	990	Buzzer control	990	Buzzer control	n14 990	PU buzzer sound control
	991	LCD contrast	991	LCD contrast	n15 991	PU contrast adjustment
Clear parameters	-	-	-	-	CLr	Parameter clear
	-	-	-	-	ECL	Alarm history clear

In the column for S500, the numbers starting with 'c' or 'n' are the parameters displayed on the in-built operation panel, and the numbers below are the parameters for FR-PU04.

Note:

1. Indicates the parameter settings which are ignored when the advanced magnetic flux vector control mode is selected.
2. Can be set when Pr. 80, Pr. 81  $\neq$  9999, Pr. 60 = 7 or 8.
3. Can be accessed when Pr. 80, Pr. 81  $\neq$  9999, Pr. 77 = 801.
4. Can be accessed when Pr. 29 = 3.

11

Connection of  
MELSEC-Q  
Series PLC

12

Connection of  
FX Series  
Positioning

13

Connection of  
FREQROL  
Inverter

14

Connection of  
Microcom-  
puter

15

Connection of  
SYSMAC C  
Series PLC

16

Connection of  
FLEX-PC N  
Series PLC

17

Connection of  
Machine Con-  
troller

18

Connection of  
FP Series PLC

19

Connection of  
SLC500  
Series PLC

20

Connection of  
SIMATIC S7  
Series PLC

### 13.6.2 Communication Parameters

The parameters shown in the table below correspond to the following communication ports respectively.

- In the A500 Series, the following parameters are communication parameters for the FR-A5NR computer link option.
- In the E500 Series, only the PU port is available.
- In the S500 Series, the following parameters are available if the RS-485 communication function is provided.

If an inverter is connected to the PU port other than above, set the parameters using Pr. 117 to Pr. 124 shown in the previous page.)

Function	A500		E500		S500	
	Pr	Name	Pr	Name	Pr	Name
Computer link function	331	Inverter station number			n1 331	Inverter station number
	332	Communication speed			n2 332	Communication speed
	333	Stop bit length			n3 333	Stop bit length
	334	Parity check yes/no			n4 334	Parity check yes/no
	335	Communication retry count			n5 335	Communication retry count
	336	Communication check time interval			n6 336	Communication check time interval
	337	Waiting time setting			n7 337	Waiting time setting
	338	Operation command right			n8 338	Operation command right
	339	Speed command right			n9 339	Speed command right
	340	Link start mode selection			n10 340	Link start mode selection
	341	CR•E LF yes/no selection			n11 341	CR•E LF yes/no selection
	342	E <sup>2</sup> PROM write selection			n12 342	E <sup>2</sup> PROM write selection
	-	-			n13 145	PU display language
	-	-			n14 990	PU buzzer sound control
	-	-			n15 991	PU contrast adjustment
-	-			n16 992	PU main display screen data selection	
-	-			n17 993	PU disconnection detection/PU setting lock	

### 13.7 Setting of Connected Equipment for GOT

The setting for connection to the FREQROL Series inverter can be executed using the GOT-F900 and the screen creation software (GT Designer2, GT Designer or DU/WIN).

#### 1) GOT-F900 Series

When the main menu screen change operation is disabled.

Operation	Display (screen name)
a) While pressing and holding the upper left corner of the screen, turn on the power. Keep holding the upper left corner for about 25 seconds more. Then, press "END" at the upper right corner.	The "LANGUAGE" screen appears.
b) Press "PLC TYPE".	The "SET-UP MODE" screen appears.
c) Set the following. PLC TYPE:FREQROL CONNECTION:CPU PORT (RS-422) DST STATION # (STATION #) : 00 GOT STATION # (-) : -	The "PLC TYPE" screen appears.

When the main menu screen change operation is enabled.

Operation	Display (screen name)
a) Press the upper left corner of the screen. (The position to be pressed can be changed in the GOT and the screen creation software.)	The "SELECT MODE" screen appears.
b) Press "OTHER MODE" on the menu.	The "OTHER MODE" screen appears.
c) Press "SET-UP MODE" on the menu.	The "SET-UP MODE" screen appears.
d) Press "PLC TYPE".	The "PLC TYPE" screen appears.
e) Set the following. PLC TYPE: FREQROL CONNECTION:CPU PORT (RS-422) DST STATION # (STATION #) : 00 GOT STATION # (-) : -	

- When the screen data is transferred to the GOT-F900, the old data including the PLC type, connection type, and station number are overwritten.

- 11 Connection of MELSEC-Q Series PLC
- 12 Connection of FX Series Positioning
- 13 Connection of FREQROL Inverter
- 14 Connection of Microcomputer
- 15 Connection of SYSMAC C Series PLC
- 16 Connection of FLEX-PC N Series PLC
- 17 Connection of Machine Controller
- 18 Connection of FP Series PLC
- 19 Connection of SLC500 Series PLC
- 20 Connection of SIMATIC S7 Series PLC

2) GT Designer2

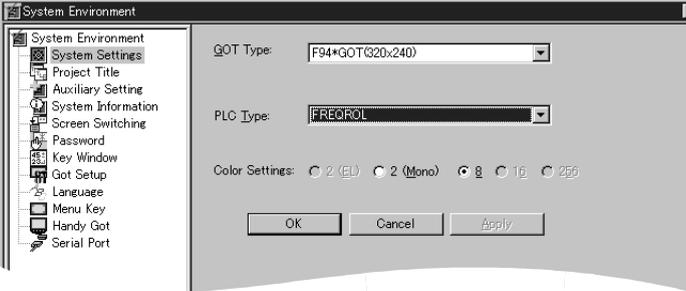
	Operation	Display (screen name)								
[Creation]	<p>a) Open GT Designer2.</p> <p>b) Click the [NEW] button. The dialog box shown below is displayed. If it is not displayed, click "System Environment" in the tree displayed in the project work space, then click "System settings" in the tree.</p>  <p>c) Set the following. GOT type: F940WGOT (480 × 234)           F94*GOT (320 × 240)           F93*GOT (240 × 80) PLC type: FREQROL Selection of "GOT type"</p> <table border="1" data-bbox="485 1043 1114 1263"> <thead> <tr> <th>GOT type</th> <th>Model name (name)</th> </tr> </thead> <tbody> <tr> <td>F940WGOT(480×234)&lt;WIDE&gt;</td> <td>F940WGOT</td> </tr> <tr> <td>F94*GOT(320×240)</td> <td>F940GOT Handy GOT</td> </tr> <tr> <td>F93*GOT(240×80)</td> <td>F930GOT F930GOT-K</td> </tr> </tbody> </table> <p>Click [OK].</p>	GOT type	Model name (name)	F940WGOT(480×234)<WIDE>	F940WGOT	F94*GOT(320×240)	F940GOT Handy GOT	F93*GOT(240×80)	F930GOT F930GOT-K	<p>The "Select Project" dialog box appears.</p> <p>The "System Environment" dialog box appears.</p>
GOT type	Model name (name)									
F940WGOT(480×234)<WIDE>	F940WGOT									
F94*GOT(320×240)	F940GOT Handy GOT									
F93*GOT(240×80)	F930GOT F930GOT-K									

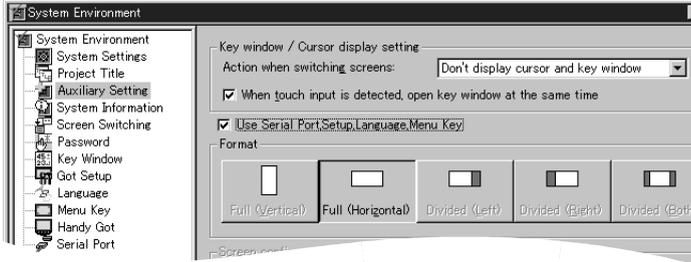
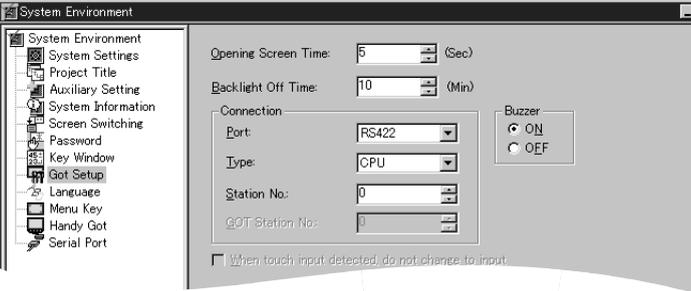

	Operation	Display (screen name)
	<p>d) Setting the port (RS-422) of the GOT-F900</p> <p>Click "Auxiliary Setting" in the tree of the system environment menu.</p> <p>Click the check box of "Use Serial Port, Setup, Language, Menu Key" to give a check mark (✓).</p>  <p>Click "Got Setup" in the tree of the system environment menu.</p>  <p>e) Set the following.</p> <p>Port : RS-422</p> <p>Type : CPU</p> <p>Station No. : 00</p> <p>GOT Station No. : -</p>	<p>The "Auxiliary Settings" dialog box appears.</p>
[Change method]	<p>Change the connection type of the already created data as follows.</p> <p>a) Open GT Designer.</p> <p>b) Click the [Project]-[Open] button.</p> <p>c) Open (read) the screen data to be changed.</p> <p>d) On the menu, select "Common"-&gt;"System Environment".</p> <ul style="list-style-type: none"> <li>- For the contents of setting, refer to c) of [Creation] above.</li> <li>- For selection of the RS-422 on the FREQROL Series inverter, refer to e) of [Creation] above.</li> </ul>	<p>The "Select Project" dialog box appears.</p> <p>The "System Environment" dialog box appears.</p>

3) GT Designer

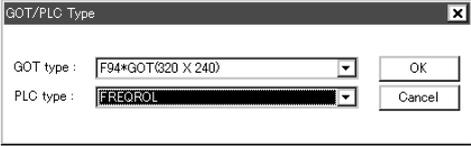
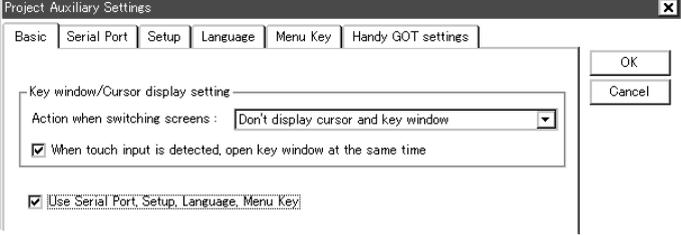
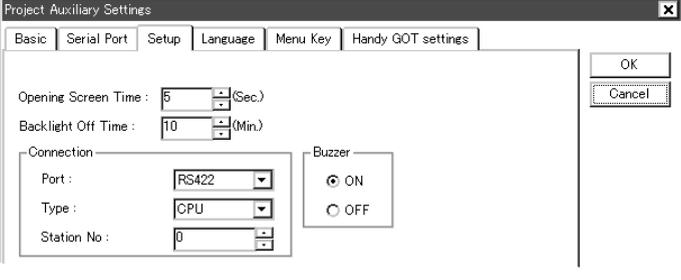
	Operation	Display (screen name)								
[Creation]	<p>a) Open GT Designer.</p> <p>b) Click the [New] button.</p>  <p>c) Set the following.            GOT type: F940WGOT (480 × 234)                      F940GOT (320 × 240)                      F930GOT (240 × 80)            PLC type: FREQROL            Selection of "GOT type"</p> <table border="1" data-bbox="497 768 1106 969"> <thead> <tr> <th>GOT type</th> <th>Model name</th> </tr> </thead> <tbody> <tr> <td>F940WGOT(480×234)&lt;WIDE&gt;</td> <td>F940WGOT</td> </tr> <tr> <td>F94*GOT(320×240)</td> <td>F940GOT Handy GOT</td> </tr> <tr> <td>F93*GOT(240×80)</td> <td>F930GOT-K F930GOT</td> </tr> </tbody> </table> <p>Click [OK].</p> <p>d) Set CPU direct connection (RS-422) of the GOT-F900.            Click the check box of "Use Serial Port, Setup, Language, Menu Key" to give a check mark (✓).</p>  <p>Click the "Setup" tab.</p>  <p>e) Set the following.            Port : RS-422            Type : CPU            DST Station No. (Station No.): 00            GOT Station No. (-) : -</p>	GOT type	Model name	F940WGOT(480×234)<WIDE>	F940WGOT	F94*GOT(320×240)	F940GOT Handy GOT	F93*GOT(240×80)	F930GOT-K F930GOT	<p>The "Select Project" dialog box appears.</p> <p>The "GOT/PLC Type" dialog box appears.</p> <p>The "Project Auxiliary Settings" dialog box appears.</p>
GOT type	Model name									
F940WGOT(480×234)<WIDE>	F940WGOT									
F94*GOT(320×240)	F940GOT Handy GOT									
F93*GOT(240×80)	F930GOT-K F930GOT									

Operation		Display (screen name)
[Change method]	Change the connection type of the already created data as follows. a) Open GT Designer. b) Click the [Open] button. c) Open (read) the screen data to be changed. d) On the menu, select "Common"- "GOT/PLC Type". - For the contents of setting, refer to c) of [Creation] above. - For selection of the RS-422 on the FREQROL Series inverter, refer to e) of [Creation] above.	The "Select Project" dialog box appears.       The "GOT/PLC Type" dialog box appears.

11

Connection of  
MELSEC-Q  
Series PLC

12

Connection of  
FX Series  
Positioning

13

Connection of  
FREQROL  
Inverter

14

Connection of  
Microcom-  
puter

15

Connection of  
SYSMAC C  
Series PLC

16

Connection of  
FLEX-PC N  
Series PLC

17

Connection of  
Machine Con-  
troller

18

Connection of  
FP Series PLC

19

Connection of  
SLC500  
Series PLC

20

Connection of  
SIMATIC S7  
Series PLC

4) DU/WIN

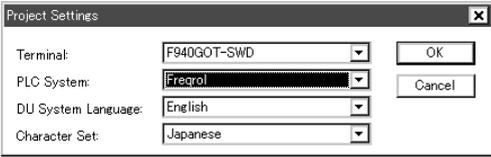
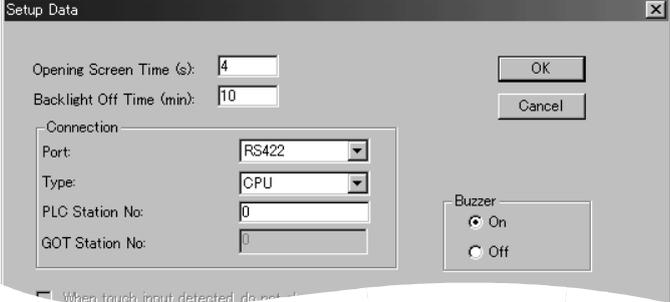
	Operation	Display (screen name)										
<p>[Creation]</p> <p>In the case of RS-422 connection</p>	<p>a)Open DU/WIN.</p> <p>b)On the menu, select "File"-"New".</p>  <p>c)Set the following.                      Terminal: F940WGOT-TWD (V) (H)                      F940GOT-LWD                      F940GOT-SWD                      F930GOT-BWD (V) (H)                      PLC System: FREQROL</p> <p>Select "Terminal" in accordance with the LC display color.</p> <table border="1" data-bbox="466 792 1134 1079"> <thead> <tr> <th>Terminal</th> <th>Model name</th> </tr> </thead> <tbody> <tr> <td>F940WGOT-TWD (V)(H)</td> <td>F940WGOT (color)</td> </tr> <tr> <td>F940GOT-LWD</td> <td>F940GOT (black and white) Handy GOT (black and white)</td> </tr> <tr> <td>F940GOT-SWD</td> <td>F940GOT (color) Handy GOT (color)</td> </tr> <tr> <td>F930GOT-BWD (V)(H)</td> <td>F930GOT-K (blue) F930GOT (blue)</td> </tr> </tbody> </table> <p>d)Set RS-422 of the GOT-F900.                      On the menu, select "View/Project"-"System Settings"-"Setup Data".</p>  <p>e)Set the following.                      Port: RS-422                      Type: CPU                      DST Station No. (Station No.): 00                      GOT Station No. (-) : -  <u>In the case of F943 Handy GOT</u>                      Without regard to the port setting (RS-422 or RS-232C), the COM0 side of the RS-232C is fixed for PLC connection.</p>	Terminal	Model name	F940WGOT-TWD (V)(H)	F940WGOT (color)	F940GOT-LWD	F940GOT (black and white) Handy GOT (black and white)	F940GOT-SWD	F940GOT (color) Handy GOT (color)	F930GOT-BWD (V)(H)	F930GOT-K (blue) F930GOT (blue)	<p>The "Project settings" dialog box appears.</p> <p>The "Setup Data" dialog box appears.</p>
Terminal	Model name											
F940WGOT-TWD (V)(H)	F940WGOT (color)											
F940GOT-LWD	F940GOT (black and white) Handy GOT (black and white)											
F940GOT-SWD	F940GOT (color) Handy GOT (color)											
F930GOT-BWD (V)(H)	F930GOT-K (blue) F930GOT (blue)											
<p>[Change method]</p>	<p>Change the connection type of the already created data as follows.</p> <p>a)Open DU/WIN.</p> <p>b)On the menu, select "File"-"Open".</p> <p>c)Select and open (read) the file of the screen data to be changed.</p> <p>d)When changing "Terminal" (GOT-F900), select "View/Project"-"System Settings"-"Project settings" on the menu.                      For the contents of setting, refer to c) in [Creation] above.                      For setting of RS-422 of the FREQROL Series inverter, refer to e) in [Creation] above.</p>	<p>The "Open" dialog box appears.</p> <p>The "Project settings" dialog box appears.</p>										

### 13.8 Cable Diagram

This section explains cable diagrams to connect the GOT-F900 and the FREQROL Series inverter.

#### 13.8.1 Cautions on preparing cables

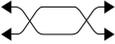
- 1) When preparing the cables, use the wire size of 0.08mm<sup>2</sup> or more (AWG28 or more) for communication, 0.3mm<sup>2</sup> or more (AWG22 or more) for the power supply, operation switch, and emergency stop switch.
- 2)  stands for a twisted pair cable. Prepare a twisted pair cable in combination of the pin numbers and signal lines described on the cable diagram.  
Do not use a twisted pair cable with the power supply wire and the communication wire.

#### 13.8.2 Cable diagram

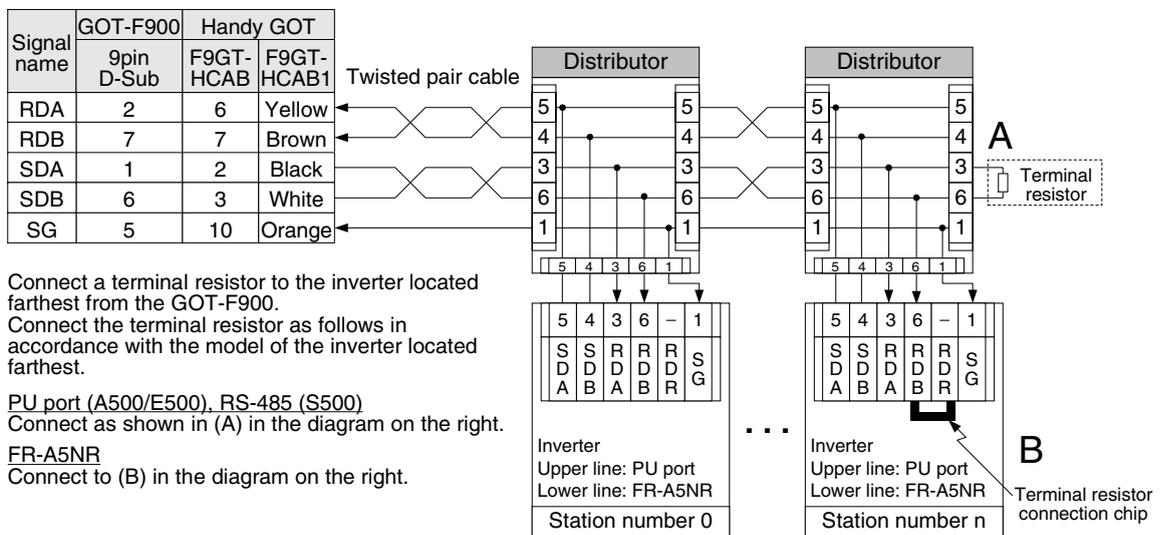

In cables connecting distributors, do not wire the pin number 2 and 8. Inverters may fail by such wiring.

1) Cable for the GOT and the FREQROL Series inverter

 : Female type  : Male type The connector figure shows the engagement face.

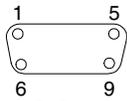
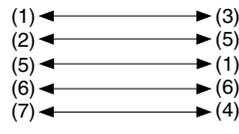
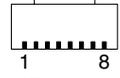
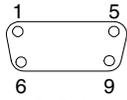
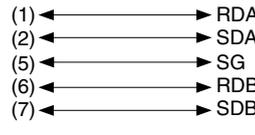
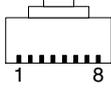
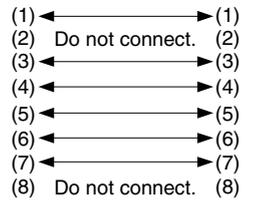
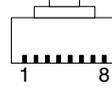
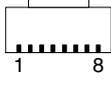
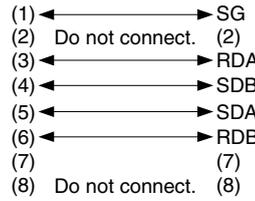
No.	Model name	Application	Connection diagram	Application
a)	<p><u>INV CPU direct connection</u> PU port of A500 Series, E500 Series or S500 Series</p> <p>RS-422 connection</p>	<p>To GOT-F900</p>  <p>9-pin D-Sub, male</p>		<p>To PU port, distributor</p>  <p>RJ-45 plug, male</p>
b)	<p><u>INV CPU direct connection</u> FR-A5NR of A500 Series</p> <p>RS-422 connection</p>	<p>To GOT-F900</p>  <p>9-pin D-Sub, male</p>		<p>To terminal block of FR-A5NR</p>
c)	<p><u>INV direct connection</u> Between distributor and distributor</p> <p>RS-422 connection</p>	<p>To distributor</p>  <p>RJ-45 plug, male</p>		<p>To distributor</p>  <p>RJ-45 plug, male</p>
d)	<p><u>INV direct connection</u> Between distributor and FR-A5NR of A500 Series</p> <p>RS-422 connection</p>	<p>To distributor</p>  <p>RJ-45 plug, male</p>		<p>To terminal block of FR-A5NR</p>

2) Cable for the Handy GOT and the FREQROL Series inverter

When using the Handy GOT RH model, refer to the cable diagrams below for the RS-422/RS-232C connector, but not the wiring for the power supply, the operation switches, and the emergency stop switch because it is different. For details, refer to Section 5.18.

 : Female type  : Male type The connector figure shows the engagement face.

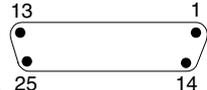
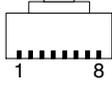
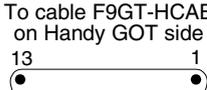
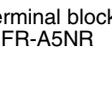
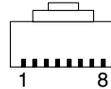
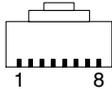
No.	Model name	Application	Connection diagram	Application	
a)	F9GT-HCAB-3M F9GT-HCAB-10M	<div style="border: 1px solid black; padding: 2px; display: inline-block;">RS-422 connection</div> <div style="border: 1px solid black; padding: 2px; display: inline-block;">RS-232C connection</div>	Dedicated connector on Handy GOT side	The connector on the leader side of the Handy GOT is dedicated, and cannot be prepared by the user.	To F9GT-HCAB2-150 or F9GT-HCAB3-150  1 13 14 25 25-pin D-Sub, male
b)	F9GT-HCAB1-3M F9GT-HCAB1-10M	<div style="border: 1px solid black; padding: 2px; display: inline-block;">RS-422 connection</div> <div style="border: 1px solid black; padding: 2px; display: inline-block;">RS-232C connection</div>	Dedicated connector on Handy GOT side	The connector on the leader side of the Handy GOT is dedicated, and cannot be prepared by the user.	Untied cable (no connector)
c)		<div style="border: 1px solid black; padding: 2px; display: inline-block;">RS-422 connection</div> To cable F9GT-HCAB on Handy GOT side  13 1 25 14 25-pin D-Sub, female	Prepared by the user The diagram on the right shows the wiring of the RS-422 signals. For wiring of the operation switches and the power supply, refer to chapter 5.	Drain wire (1) → FG (Grounding) BK (2) → (3) Y (6) → (5) O (10) → (1) W (3) → (6) BR (7) → (4) PL (12) → DC24VG PK (13) → DC24VG LTGR (14) → SW-COM / ES1-2 SB (15) → SW1 / DSW2 BK/W (16) → SW2 / DSW2 R/W (17) → SW3 / DSW1 GR/W (18) → SW4 / DSW1 O/W (20) → / ES1-2 Y/W (21) → ES1 / ES1-1 BR/W (22) → ES1 / ES1-1 BL/W (24) → DC24V+ GY/W (25) → DC24V+	To PU port, distributor  1 8 RJ-45 plug, male Wire the power supply, the operation switches and the emergency stop switch. Old cable description New cable description
d)		<div style="border: 1px solid black; padding: 2px; display: inline-block;">RS-422 connection</div> To cable F9GT-HCAB on Handy GOT side  13 1 25 14 25-pin D-Sub, female	Prepared by the user The diagram on the right shows the wiring of the RS-422 signals. For wiring of the operation switches and the power supply, refer to chapter 5.	Drain wire (1) → FG (Grounding) BK (2) → RDA Y (6) → SDA O (10) → SG W (3) → RDB BR (7) → SDB PL (12) → DC24VG PK (13) → DC24VG LTGR (14) → SW-COM / ES1-2 SB (15) → SW1 / DSW2 BK/W (16) → SW2 / DSW2 R/W (17) → SW3 / DSW1 GR/W (18) → SW4 / DSW1 O/W (20) → / ES1-2 Y/W (21) → ES1 / ES1-1 BR/W (22) → ES1 / ES1-1 BL/W (24) → DC24V+ GY/W (25) → DC24V+	To terminal block of FR-A5NR  Wire the power supply, the operation switches and the emergency stop switch. Old cable description New cable description
e)		<div style="border: 1px solid black; padding: 2px; display: inline-block;">RS-422 connection</div> To distributor  1 8 RJ-45 plug, male	Prepared by the user Between distributor and distributor	(1) → (1) (2) Do not connect. (2) (3) → (3) (4) → (4) (5) → (5) (6) → (6) (7) → (7) (8) Do not connect. (8)	To distributor  1 8 RJ-45 plug, male

 : Female type  : Male type The connector figure shows the engagement face.

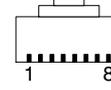
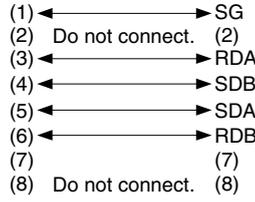
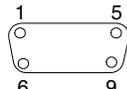
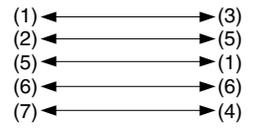
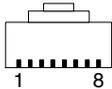
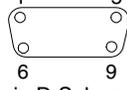
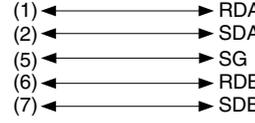
No.	Model name	Application	Connection diagram	Application
f)	<div style="border: 1px solid black; padding: 2px; display: inline-block;">RS-422 connection</div> INV direct connection Between distributor and FR-A5NR of A500 Series	To distributor  RJ-45 plug, male		To terminal block of FR-A5NR
g)	<div style="border: 1px solid black; padding: 2px; display: inline-block;">RS-422 connection</div> INV direct connection PU port (A500, E500 Series) RS-485 (S500 Series) Distributor	To F9GT-HCNB  9-pin D-Sub, male		To PU port  RJ-45 plug, male
h)	<div style="border: 1px solid black; padding: 2px; display: inline-block;">RS-422 connection</div> INV CPU direct connection FR-A5NR (A500 Series)	To F9GT-HCNB  9-pin D-Sub, male		To terminal block of FR-A5NR

**3) Connectors and connector covers to be used**

a) Connector on the GOT side

For the connectors used in the GOT-F900 and the Handy GOT, refer to the description on corresponding dedicated wiring.

b) Connector of cable between FREQROL Series inverters

Use the commercial connectors and cables shown in the table below or the comparable products. (Refer to the manual for the inverter.)

Introduced products (as of June, 2000)

Name	Model name	Specifications	Manufacturer
Connector	5-554720-3	RJ45 connector	Tyco Electronics AMP K.K.
Modular ceiling rosette	BMJ-8		HACHIKO ELECTRIC CO.,LTD.
Cable	SGLPEV 0.5mm×4P	Cable conforming to EIA568 (such as cable 10BASE-T)	mitsubishi cable industries, LTD.



### 13.9 Troubleshooting

For reference, this section summarizes frequently asked questions about connection of the GOT-F900 to the FREQROL Series inverter.

#### 1) GOT-F900

Contents of trouble	Check points and countermeasures	OS version		
		F940W	F940	F930
"COMMUNICATION ERROR OCCURS" is displayed when a screen changeover or numeric data input is performed on the GOT-F900 screen.	The power of the FREQROL inverter is turned off. <ul style="list-style-type: none"> <li>• Cause Communication is disabled because the power of the FREQROL inverter is turned off.</li> <li>• Countermeasures Turn on the power.</li> </ul>	From first product	From first product	From first product
	Something is wrong with the cable between the GOT-F900 and the FREQROL. <ul style="list-style-type: none"> <li>• Causes The wrong cable is used or the connection is bad.</li> <li>• Countermeasures Check the cable.</li> </ul>			
"DISPLAY SCREEN IS NOT AVAILABLE." is displayed on the GOT-F900 screen.	Changeover to a nonexistent screen was tried by a touch key. <ul style="list-style-type: none"> <li>• Cause The changeover destination screen has not been created yet.</li> <li>• Countermeasures Create the screen.</li> </ul>	-	Earlier than 6.00	Earlier than 4.00
"DISPLAY SCREEN IS NOT AVAILABLE. (NO. #####)" is displayed on the GOT-F900 screen.	A nonexistent screen was tried to be displayed. <ul style="list-style-type: none"> <li>• Cause The screen No. ##### has not been created yet.</li> <li>• Countermeasures Create the screen.</li> </ul>	From first product	6.00 or later	4.00 or later
"DISPLAY SCREEN IS NOT AVAILABLE." is displayed on the GOT-F900 screen.	A device that does not exist in the FREQROL inverter was referenced. (Example: While an S500 Series is connected, a device exists only in the A500 Series is specified for numeric input.) <ul style="list-style-type: none"> <li>• Cause On the changeover destination screen (excluding the head screen), a nonexistent device in the connected FREQROL inverter is specified.</li> <li>• Countermeasures Check the devices used on the head screen.</li> </ul>	-	Earlier than 6.00	Earlier than 4.00
	There is an error on the screen to be displayed. <ul style="list-style-type: none"> <li>• Cause One of the screen objects is placed outside the available screen area.</li> <li>• Countermeasures Check the placement of screen objects.</li> </ul>			

- 11 Connection of MELSEC-Q Series PLC
- 12 Connection of FX Series Positioning
- 13 Connection of FREQROL Inverter
- 14 Connection of Micro-computer
- 15 Connection of SYSMAC C Series PLC
- 16 Connection of FLEX-PC N Series PLC
- 17 Connection of Machine Controller
- 18 Connection of FP Series PLC
- 19 Connection of SLC500 Series PLC
- 20 Connection of SIMATIC S7 Series PLC

Contents of trouble	Check points and countermeasures	OS version		
		F940W	F940	F930
"DISPLAY SCREEN IS NOT AVAILABLE. (NO. ####)" is displayed on the GOT-F900 screen.	<p>The display screen contains an error.</p> <ul style="list-style-type: none"> <li>Causes A device that does not exist in the connected PLC is referenced on the screen No. ####, or one of the screen objects is placed outside the available screen area.</li> <li>Countermeasures Check the devices used and placement of screen objects.</li> </ul>	From first product	6.00 or later	4.00 or later
"DATA IS NOT FOUND." is displayed on the GOT-F900 screen.	<p>There is not data because the unit is new or the memory clear has been executed.</p> <ul style="list-style-type: none"> <li>Cause There is no screen data.</li> <li>Countermeasures Write the screen data using the screen creation software.</li> </ul>	-	Earlier than 6.00	Earlier than 4.00
	<p>A device that does not exist in the FREQROL inverter was referenced. (Example: While an S500 Series is connected, a device exists only in the A500 Series is specified for numeric input.)</p> <ul style="list-style-type: none"> <li>Cause On the head screen, a nonexistent device in the connected FREQROL inverter is specified. (The head screen is the screen No. 1 in the GT Designer, and the screen No. 0 in the DU/WIN.)</li> <li>Countermeasures Check the devices used on the head screen.</li> </ul>			
	<p>There is not data because the unit is new or the memory clear has been executed.</p> <ul style="list-style-type: none"> <li>Cause There is no screen data.</li> <li>Countermeasures Write the screen data using the screen creation software.</li> </ul>	From first product	6.00 or later	4.00 or later
"CAN NOT WRITE TO PLC MEMORY." is displayed on the GOT-F900 screen.	This error is not displayed.	Earlier than 1.10	Earlier than 6.10	Earlier than 4.10
"CAN NOT WRITE." is displayed on the GOT-F900 screen.	<p>A parameter (Pr) in the FREQROL inverter was tried to be changed.</p> <ul style="list-style-type: none"> <li>Cause The FREQROL inverter is not set to the computer link operation mode or the inverter is running.</li> <li>Countermeasures In the manual of the FREQROL inverter, confirm the allowable write range in each operation mode.</li> </ul>	1.10 or later	6.10 or later	4.10 or later
"CAN NOT USE THE FUNCTION WHILE PROTECTED." is displayed on the GOT-F900 screen.	This error is not displayed.	From first product	From first product	From first product
"PLC IS RUNNING." is displayed on the GOT-F900 screen.	This error is not displayed.	From first product	From first product	From first product

2) Software

	Contents of trouble	Check points and countermeasures
Screen creation software	Communication with the screen creation software and screen data cannot be transferred.	<p>A bar code reader or printer is connected. (Such equipment cannot be connected to the FREQROL inverter.)</p> <ul style="list-style-type: none"> <li>• Causes The RS-232C connector to which the personal computer is connected is set to be used for another piece of equipment.</li> <li>• Countermeasures In the GOT-F900, select by hand "SELECT MODE"- "OTHER MODE"- "DATA TRANSFER". Or set a bar code reader to invalid and a printer" to "DON'T USE".</li> </ul>
		<p>Something is wrong with the cable between the GOT-F900 and the personal computer.</p> <ul style="list-style-type: none"> <li>• Causes The connected cable is not proper. Or cable connection is not correct.</li> <li>• Countermeasures Check the cable.</li> </ul>

11

Connection of MELSEC-Q Series PLC

12

Connection of FX Series Positioning

13

Connection of FREQROL Inverter

14

Connection of Microcomputer

15

Connection of SYSMAC C Series PLC

16

Connection of FLEX-PC N Series PLC

17

Connection of Machine Controller

18

Connection of FP Series PLC

19

Connection of SLC500 Series PLC

20

Connection of SIMATIC S7 Series PLC

# MEMO

## 14. Connection of Microcomputer

This chapter explains the procedure to connect the GOT-F900 Series display unit to controllers such as a microcomputer board having the serial communication function (RS-422/RS-232C) and a personal computer (hereafter referred to as "microcomputer").

### Connection Procedure

The procedure to connect the microcomputer is introduced.

#### 1. Preparation

Item name	Description	Reference
System Condition	You can learn the connection availability as well as the version of the GOT-F900 OS and the screen creation software.	14.1
System Configuration	You can select the configuration of between the GOT and the microcomputer and proper cables.	14.2

#### 2. Setting

Item name	Description	Reference
Outline of Communication and Specifications	Outline of Communication	The outline of data transferred between the microcomputer and the GOT 14.3.1
	Communication Setting Specifications	The communication specification values available in the GOT 14.3.2
Memory Map	You can learn the detailed contents of the memory inside the GOT.	
	Data Area	Addresses specified from the microcomputer and assignment of the word data (D) and the bid data (M) inside the GOT 14.4.1
	Special Memory Data List	The assignment status of the memory inside the GOT used for special application 14.4.2
	Error Code List	Codes of errors related to communication which are stored in D8002 14.4.3
Communication Command	You can learn the detailed contents of communication commands of the microcomputer.	
	Outline of Communication Procedure	The outline of data transmission 14.5.1
	Command List and Compatible Version of GOT-F900	The types of commands used in transmission and receive between the GOT 14.5.2
	Data Transfer Format	The chart of the data transfer format 14.5.3
	Character code list	The characters available in statements 14.5.4
	Station Number Setting	Procedure of station number setting 14.5.5
	Sum Check Code	The contents of the sum check code included in the data format 14.5.6
	Interrupt Code List	The correspondence between interrupt codes and event types 14.5.7

Item name	Description	Reference		
Command Details	You can learn the operation of each communication command.		14.6	
	Batch Read Command (RD)	The format used to read data from the GOT to the microcomputer		14.6.1
	Batch Write Command (WR)	The format used to write data from the microcomputer to the GOT		14.6.2
	Bit-oriented Write Command	The format used to write the bit device to the GOT according to a specified pattern		14.6.3
	Fill Command	The format used to write data to a specified range in the GOT		14.6.4
	Interrupt Code	The function of interrupt code		14.6.5
Caution on Use of Microcomputer Connection	You can learn the restrictions when the GOT is connected to the microcomputer.	14.7		
Setting of Connected Equipment for GOT	Set the PLC (microcomputer) type and the communication specifications using the GOT or the screen creation software.	14.8		

### 3. Others

Item name	Description	Reference
Cable Diagram	Cable diagrams for Microcomputer/GOT connection	14.9
Troubleshooting	Description of errors and how to fix them	14.10
BASIC Program Example	BASIC programs for the personal computer connected to the GOT for communication.	14.11

## 14.1 System Condition

When connecting the microcomputer, check the COM port designation, the OS version of the GOT-F900, and applicable versions of the screen creation software.

Compatibility when connecting microcomputer

GOT-F900 Series	COM port		Connection type		OS version of GOT-F900	Version of screen creation software		
	RS-422	RS-232C	1:1	Two or more GOT units		GT Designer2	GT Designer	DU/WIN
F920GOT-K(5V)	–	–	–	–	–	–	–	–
F920GOT-K(24V)	✓	✓	✓	–	1.20	SW1-C	–	–
F930GOT	✓	✓	✓	✓*2	1.00	SW1-C	SW1-H	2.20
F930GOT-K	✓	✓	✓	✓*2	4.60	SW1-C	SW5-26C	2.70
F940GOT	✓	✓	✓	✓*2	1.00	SW1-C	SW1-A	2.00
F940WGOT	✓	✓	✓	✓*2	1.00	SW1-C	SW5-F	2.50
F940 Handy GOT	✓	–	✓	–*1*2	1.00	SW1-C	SW1-D	2.10
F943 Handy GOT	–	✓	✓	–*1*2	1.00	SW1-C	SW1-D	2.10

- The screen creation software version corresponds to the model of the GOT-F900 Series. Refer to section 3.2.

\*1 The RS-232C port for the Handy type GOT is provided inside the rear cover. As a result, environmental protection is lost when using this port and such a connection is not practical. (The Handy GOT can be connected as the final unit in a string of two or more GOTs.)

\*2 Connection of two or more GOT units is possible from the version shown in the table below.

For details about screen creation software version, setting method in GOT, and cable between GOTs, refer to Chapter 7.

Type	F930GOT	F930GOT-K	F940GOT	F940WGOT	Handy GOT
Applicable version of GOT-F900	3.00	4.60	5.00	1.00	5.00

## 14.2 System Configuration

The microcomputer can be directly connected to the GOT via RS-422 or RS-232C. This section explains the cables required in such a system.

### 14.2.1 Configuration for CPU Direct Connection (RS-422)

Connect the GOT-F900 to the RS-422 communication port of the microcomputer.

#### 1) F920GOT-K (24V type)/F930GOT/F930GOT-K/F940GOT/F940WGOT

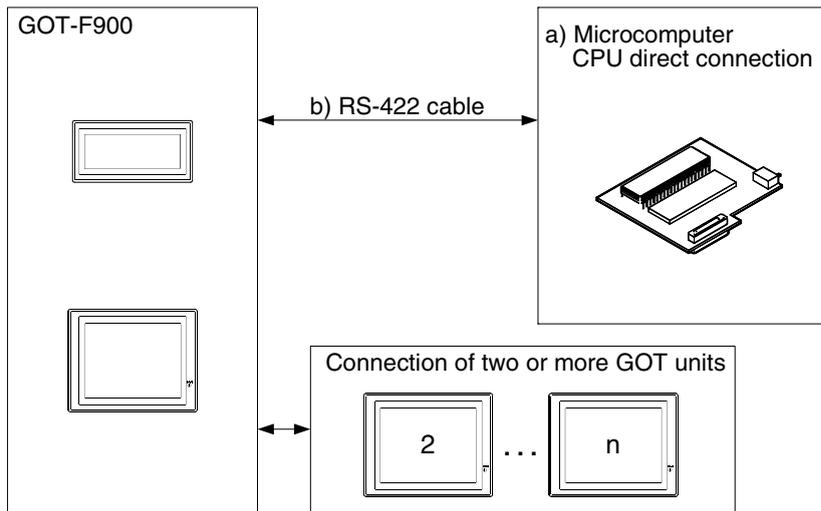

a) Microcomputer	b) RS-422 cable	Remarks
CPU direct connection	Prepared by the user.	

2) F940 Handy GOT

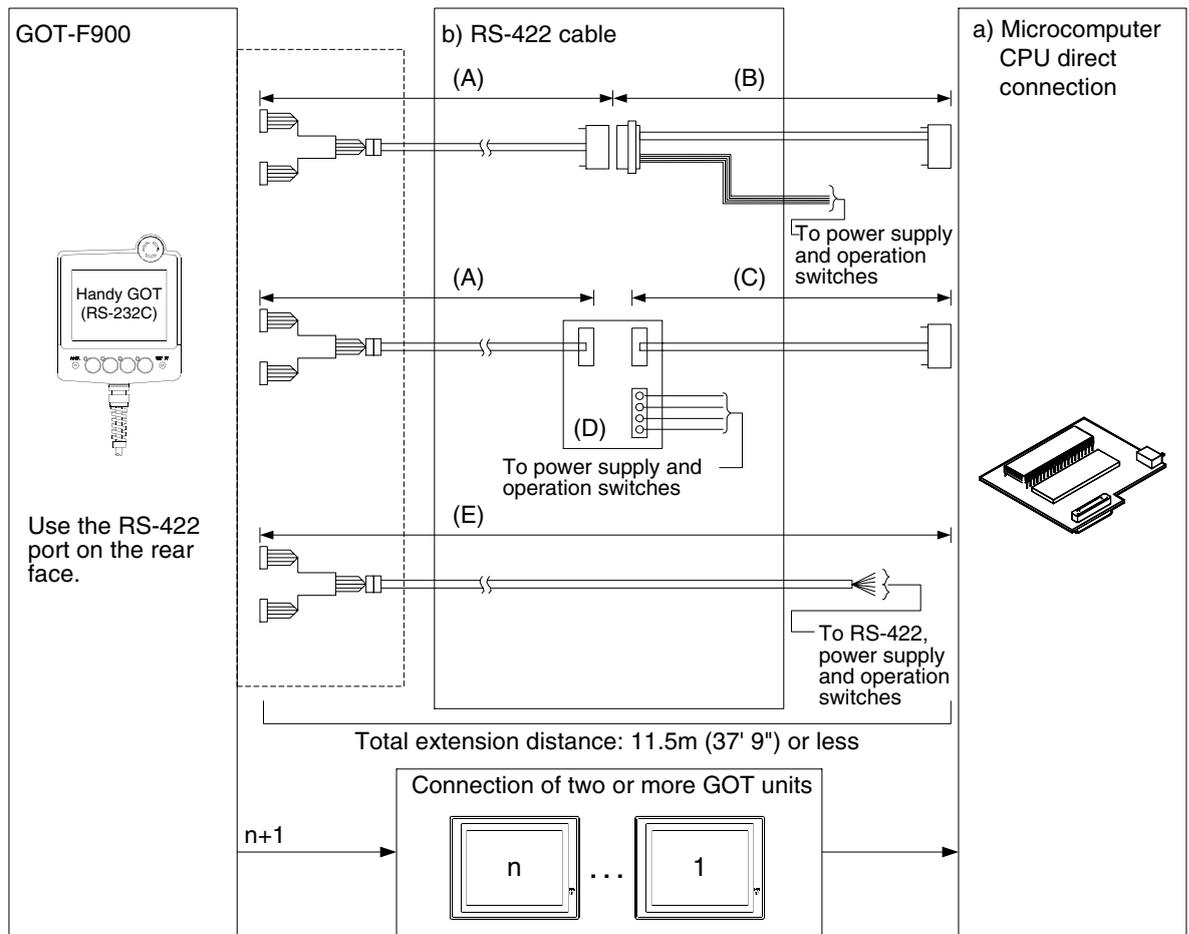

a) Microcomputer	b) RS-422 cable	Remarks
CPU direct connection	(A) F9GT-HCAB-□□M (B) Prepared by the user. (C) Prepared by the user. (D) F9GT-HCNB (E) F9GT-HCAB1-□□M	



### 14.2.2 Configuration for CPU Direct Connection (RS-232C)

Connect the GOT-F900 to the RS-232C communication port of the microcomputer.

#### 1) F920GOT-K (24V type)/F930GOT/F930GOT-K/F940GOT/F940WGOT

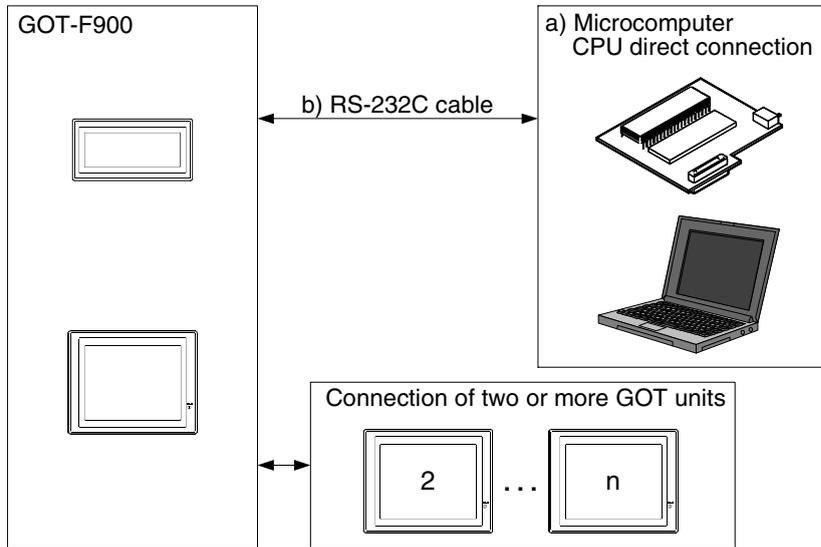

a) Microcomputer	b) RS-232C cable	Remarks
CPU direct connection	Prepared by the user.	

#### 2) F943 Handy GOT

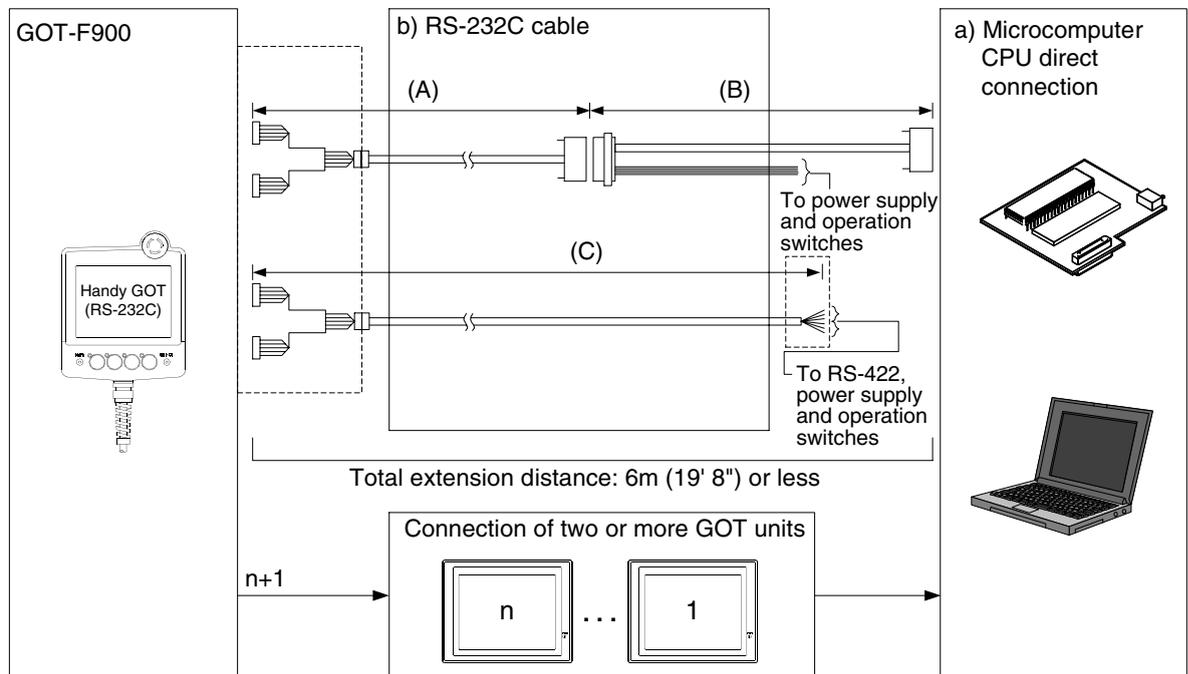

a) Microcomputer	b) RS-232C cable	Remarks
CPU direct connection	(A) F9GT-HCAB-3M (B) Prepared by the user. (C) F9GT-HCAB1-3M	

- Make sure that the total cable extension distance "(A) + (B)" or (C) is 6 m or less.

### 14.3 Outline of Communication and Specifications

When the GOT-F900 is connected to the microcomputer, the outline of data transfer and the communication specifications should be set as described below.

#### 14.3.1 Outline of Communication

##### 1) Outline

In microcomputer connection, the microcomputer functions as the master station, and the GOT-F900 functions as the slave station. The GOT-F900 is equipped with the built-in data area in which word data and bit data are stored. The microcomputer executes read and write to this internal data area using communication commands.

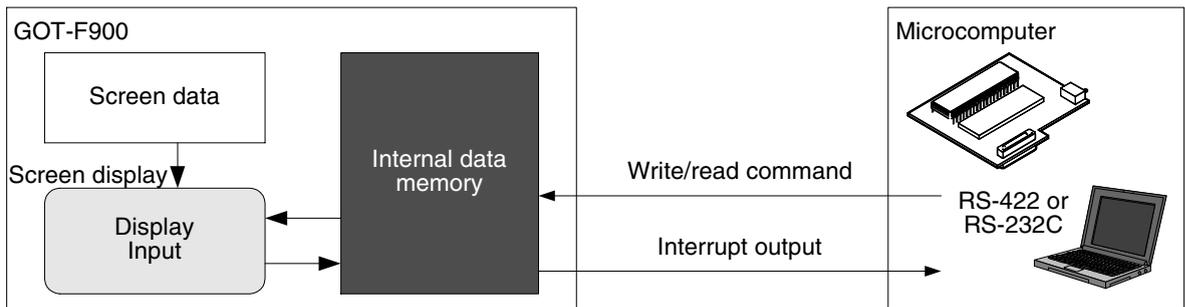

##### 2) Screen display and outline of control

The display and the contents of control in the GOT-F900 are determined by the screen data created by the screen creation software installed in the personal computer. The screen data specifies the layout of objects displayed on the screen or actions to be executed when touch keys are pressed. Some functions access the data such as the function to display word devices in the "numeric value" or "bar graph" format and the function to change the bit data status by "switches" access the data in the internal data area. The access target in such cases is the internal data area. The location of the data to be accessed is specified by the screen data.

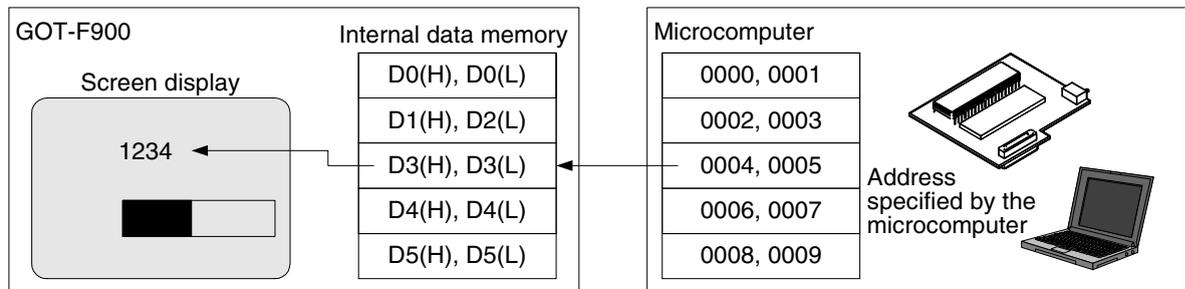

##### 3) Write command and read command

When the data stored in the microcomputer is to be displayed on the screen, the microcomputer should transfer it to the internal data area of the GOT-F900 using the write command. The transfer destination is specified by the screen data. The result of data change by the key operation can be transferred from the internal data area of the GOT to the microcomputer if the microcomputer gives the read command. As the trigger of change, the interrupt code can be transmitted.

### 14.3.2 Communication Setting Specifications

The table below shows the transmission specifications available in the GOT-F900. Set the transmission specifications in accordance with those in the microcomputer.

Item		Setting range	Setting in microcomputer
Baud rate		19200 or 9600 or 4800 or 2400 or 1200 or 600 or 300 bps	
Data format	Data bit	8 or 7 bits	
	Parity bit	None, even or odd	
	Stop bit	1 or 2 bits	
	Flow control	DSR/DTR or XON/XOFF	Setting invalid

- For the GOT-F900 transmission specifications setting method, refer to section 14.8.

## 14.4 Memory Map

The data stored in the GOT-F900 is classified into word data (D) and bit data (M). An address is assigned to each data, and each data is positioned as described below.

### 14.4.1 Data Area

The microcomputer specifies data by "address". The screen creation software specifies data by "D" or "M".

#### 1) Word data (D)

There are 4096 word devices (D0 to D4095). A serial number (address) is assigned to each of them. For the number of device of F920GOT-K and F920 Handy GOT RH type, refer to Caution on Use of Microcomputer Connection.

##### a) Word data (16 bits)

Each 8-bit word data is lined in the order of upper side (H) and lower side (L).

##### b) Double word data (32 bits)

Each 16-bit word data is lined from the higher address to the lower address.

When a 32-bit numeric value is displayed on the GOT-F900, if two word devices are located in the reverse order, the correct value is not displayed because the most significant bit is regarded as the sign (+ or -).

Specification by microcomputer	Memory inside GOT-F900 (device name specified by screen creation software)*1		
	Address	Word data (16 bits)	Double word data (32 bits)
1FFFH	D4095(L)	D4095	(D4095, D4094)
1FFEH	D4095(H)		
1FFDH	D4094(L)	D4094	
1FFCH	D4094(H)		
:	:	:	
0003H	D1(L)	D1	(D1, D0)
0002H	D1(H)		
0001H	D0(L)	D0	
0000H	D0(H)		

\*1 "D\*\*\*\*" shown in this chapter indicates a virtual device inside the GOT-F900, but does not indicate any data register of the PLC.

## 2) Bit data (M)

The bit data consists of 2,048 points (M0 to M2047). The serial number (address) is assigned to each point. Each address stores 8 bit data.

For the number of device of F920GOT-K, refer to Caution on Use of Microcomputer Connection.

Specification by microcomputer	Memory inside GOT-F900 (device name specified by screen creation software)*1							
	b7	b6	b5	b4	b3	b2	b1	b0
20FFH	M2047	M2046	M2045	M2044	M2043	M2042	M2041	M2040
20FEH	M2039	M2038	M2037	M2036	M2035	M2034	M2033	M2032
20FDH	M2031	M2030	M2029	M2028	M2027	M2026	M2025	M2024
:	:	:	:	:	:	:	:	:
2003H	M31	M30	M29	M28	M27	M26	M25	M24
2002H	M23	M22	M21	M20	M19	M18	M17	M16
2001H	M15	M14	M13	M12	M11	M10	M9	M8
2000H	M7	M6	M5	M4	M3	M2	M1	M0

\*1 "M\*\*\*\*" shown in this chapter indicates a virtual device inside the GOT-F900, but does not indicate any bit device of the PLC.

## 3) Special memory

The GOT is equipped with 16 word devices (D8000 to D8015) and 64 bit devices (M8000 to M8063) for special purpose. For the detailed contents such as function of each device, refer to the next page.

### a) Word data

Description	Address specified by microcomputer	Memory inside GOT-F900 (device name specified by screen creation software)*1
		Word data (16 bits)
Not used	211FH	D8015(L)
	211EH	D8015(H)
	:	:
	2107H	D8003(L)
	2106H	D8003(H)
Communication error code	2105H	D8002(L)
	2104H	D8002(H)
Accumulated operating time of GOT (unit: 100 ms)	2103H	D8001(L)
	2102H	D8001(H)
	2101H	D8000(L)
	2100H	D8000(H)

\*1 "D\*\*\*\*" shown in this chapter indicates a virtual device inside the GOT-F900, but does not indicate any data register of the PLC.

## b) Bit data

Description	Address specified by microcomputer	Memory inside GOT-F900 (device name specified by screen creation software)*1							
		b7	b6	b5	b4	b3	b2	b1	b0
Not used	2207H	M8063	M8062	M8061	M8060	M8059	M8058	M8057	M8056
	2206H	M8055	M8054	M8053					
				M8052					
					M8051				
						M8050			
Interrupt output								M8049	M8048
	2205H	M8047	M8046	M8045	M8044	M8043	M8042	M8041	M8040
	2204H	M8039	M8038	M8037	M8036	M8035	M8034	M8033	M8032
	2203H	M8031	M8030	M8029	M8028	M8027	M8026	M8025	M8024
	2202H	M8023	M8022	M8021	M8020	M8019	M8018	M8017	M8016
	2201H	M8015	M8014	M8013	M8012	M8011	M8010	M8009	M8008
	2200H	M8007	M8006	M8005	M8004	M8003	M8002	M8001	M8000

\*1 "M\*\*\*\*\*" shown in this chapter indicates a virtual device inside the GOT-F900, but does not indicate any bit device of the PLC.

## c) Clock data storage addresses

The data on the real-time clock built in the GOT is stored in the following order. Each 16-bit data is stored in the order of upper side and lower side. F920GOT-K and F920 Handy GOT RH model do not have the real-time clock, so this function is not available.

Data of time and date can be read from the microcomputer. (Writing must not be performed.)

Time of real-time clock cannot be changed. Changing the time is possible only on the current time screen on the system screen.

Description	Address specified by microcomputer	Memory inside GOT-F900 (device name specified by screen creation software)	Remarks
Time (second)	3000H 3001H	GD0	00 to 59 (second)
Time (minute)	3002H 3003H	GD1	00 to 59 (minute)
Time (hour)	3004H 3005H	GD2	00 to 23 (hour)
Date (day)	3006H 3007H	GD3	01 to 31 (day)
Date (month)	3008H 3009H	GD4	01 to 12 (month)
Date (year)	300AH 300BH	GD5	1980 to 2079 (year)
Date (day of week)	300CH 300DH	GD6	0 (Sunday) to 6 (Saturday)

## 14.4.2 Special Memory Data List

Word device	Description																												
D8000, D8001	32-bit counter of 100ms The time after the power is turned on is counted in the unit of 100ms. The lower word is stored in D8000, and the upper word is stored in D8001.																												
D8002 (Refer to the error code list.)	<p>Contents of communication error in its own station (error code) Contents of communication error in another station (error code) &lt;available in versions in which connection of two or more GOT units is enabled&gt; The contents of error in communication with the microcomputer are shown. Own station (accessed GOT side)    Another station (between accessed GOT and next GOT)</p> <table border="1"> <thead> <tr> <th>Code</th> <th>Description</th> <th>Code</th> <th>Description</th> </tr> </thead> <tbody> <tr> <td>0</td> <td>No error</td> <td>101</td> <td>Parity error</td> </tr> <tr> <td>1</td> <td>Parity error</td> <td>102</td> <td>Framing error</td> </tr> <tr> <td>2</td> <td>Framing error</td> <td>103</td> <td>Overrun error</td> </tr> <tr> <td>3</td> <td>Overrun error</td> <td>104</td> <td>Incorrect of statement</td> </tr> <tr> <td>4</td> <td>Incorrect of statement</td> <td>105</td> <td>Timeout error (no station specified)</td> </tr> <tr> <td>5</td> <td>Incorrect command</td> <td>106</td> <td>Connection of two or more units disabled*1</td> </tr> </tbody> </table> <p>*1 The error code 106 indicates that the RS-232C port is occupied by connecting of a bar code reader or printer.</p>	Code	Description	Code	Description	0	No error	101	Parity error	1	Parity error	102	Framing error	2	Framing error	103	Overrun error	3	Overrun error	104	Incorrect of statement	4	Incorrect of statement	105	Timeout error (no station specified)	5	Incorrect command	106	Connection of two or more units disabled*1
Code	Description	Code	Description																										
0	No error	101	Parity error																										
1	Parity error	102	Framing error																										
2	Framing error	103	Overrun error																										
3	Overrun error	104	Incorrect of statement																										
4	Incorrect of statement	105	Timeout error (no station specified)																										
5	Incorrect command	106	Connection of two or more units disabled*1																										
D8003 to D8015	Unused																												

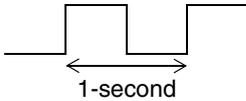
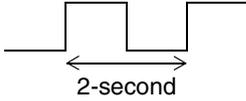
Bit device	Description																																				
M8000 to M8049	<p>Interrupt output When the bit data status is changed by a touch key, the GOT sends an interrupt code to the microcomputer.</p> <table border="1" data-bbox="545 416 1386 976"> <thead> <tr> <th>Device</th> <th>Event type</th> <th>Interrupt code (hexadecimal)</th> </tr> </thead> <tbody> <tr> <td rowspan="2">M8000</td> <td>Changed from OFF to ON.</td> <td>50H</td> </tr> <tr> <td>Changed from ON to OFF</td> <td>51H</td> </tr> <tr> <td rowspan="2">M8001</td> <td>Changed from OFF to ON.</td> <td>52H</td> </tr> <tr> <td>Changed from ON to OFF</td> <td>53H</td> </tr> <tr> <td rowspan="2">M8002</td> <td>Changed from OFF to ON.</td> <td>54H</td> </tr> <tr> <td>Changed from ON to OFF</td> <td>55H</td> </tr> <tr> <td>:</td> <td>:</td> <td>:</td> </tr> <tr> <td rowspan="2">M8047</td> <td>Changed from OFF to ON.</td> <td>AEH</td> </tr> <tr> <td>Changed from ON to OFF</td> <td>AFH</td> </tr> <tr> <td rowspan="2">M8048</td> <td>Changed from OFF to ON.</td> <td>B0H</td> </tr> <tr> <td>Changed from ON to OFF</td> <td>B1H</td> </tr> <tr> <td rowspan="2">M8049</td> <td>Changed from OFF to ON.</td> <td>B2H</td> </tr> <tr> <td>Changed from ON to OFF</td> <td>B3H</td> </tr> </tbody> </table> <p>When the data length is 7 bits, interrupt codes M8024 to M8049 are not output. Even if this data is overwritten by the microcomputer, the GOT does not output interrupt codes.</p>	Device	Event type	Interrupt code (hexadecimal)	M8000	Changed from OFF to ON.	50H	Changed from ON to OFF	51H	M8001	Changed from OFF to ON.	52H	Changed from ON to OFF	53H	M8002	Changed from OFF to ON.	54H	Changed from ON to OFF	55H	:	:	:	M8047	Changed from OFF to ON.	AEH	Changed from ON to OFF	AFH	M8048	Changed from OFF to ON.	B0H	Changed from ON to OFF	B1H	M8049	Changed from OFF to ON.	B2H	Changed from ON to OFF	B3H
Device	Event type	Interrupt code (hexadecimal)																																			
M8000	Changed from OFF to ON.	50H																																			
	Changed from ON to OFF	51H																																			
M8001	Changed from OFF to ON.	52H																																			
	Changed from ON to OFF	53H																																			
M8002	Changed from OFF to ON.	54H																																			
	Changed from ON to OFF	55H																																			
:	:	:																																			
M8047	Changed from OFF to ON.	AEH																																			
	Changed from ON to OFF	AFH																																			
M8048	Changed from OFF to ON.	B0H																																			
	Changed from ON to OFF	B1H																																			
M8049	Changed from OFF to ON.	B2H																																			
	Changed from ON to OFF	B3H																																			
M8050	<p>1-second cycle clock</p> 																																				
M8051	<p>2-second cycle clock</p> 																																				
M8052	<p>Interrupt code output forbid flag &lt;Available in versions in which connection of two or more GOT units is enabled&gt; While this bit is ON, no interrupt code is output to the microcomputer.</p>																																				
M8053 to M8063	Unused																																				

11 Connection of MELSEC-Q Series PLC

12 Connection of FX Series Positioning

13 Connection of FREQROL Inverter

14 Connection of Microcomputer

15 Connection of SYSMAC C Series PLC

16 Connection of FLEX-PC N Series PLC

17 Connection of Machine Controller

18 Connection of FP Series PLC

19 Connection of SLC500 Series PLC

20 Connection of SIMATIC S7 Series PLC

### 14.4.3 Error Code List

The following errors are stored in D8002.

Error code	Description	Action
00	No error	
01	Parity error The parity bit is not matching.	Confirm the transmission specifications of the microcomputer and the GOT-F900.
02	Framing error Data bits or stop bits are not matching.	Confirm the transmission specifications of the microcomputer and the GOT-F900.
03	Overrun error Overrun has occurred in receive.	Confirm the transmission specifications of the microcomputer and the GOT-F900.
04	Communication message error While a communication message was being received, EXT was not found by the time the upper limit of the receive buffer was exceeded.	Confirm the communication message format.
05	Command error An unsupported request command was used.	Confirm the data of the transmitted request command.
101	Parity error The parity bit is not matching.	Confirm the transmission specifications of the microcomputer and the GOT-F900.
102	Framing error Data bits or stop bits are not matching.	Confirm the transmission specifications of the microcomputer and the GOT-F900.
103	Overrun error Overrun has occurred in receive.	Confirm the transmission specifications of the microcomputer and the GOT-F900.
104	Communication message error While a communication message was being received, EXT was not found by the time the upper limit of the receive buffer was exceeded.	Confirm the communication message format.
105	Timeout error (no station specified in command) The GOT did not return a response within the specified time.	Check whether the station number specification is correct in the transmitted request command.
106	Two- or more-unit function disable error The function to connect two or more GOT units is disabled.	The RS-232C port is occupied by connecting of a bar code reader or printer.



## 14.5 Communication Command

This section explains commands used in communication.

### 14.5.1 Outline of Communication Procedure

#### 1) Command transmission (outline)

Communication between the GOT-F900 units and the microcomputer is executed in the procedure in which the microcomputer sends a command and a GOT-F900 unit returns a response to it. While a GOT-F900 unit is sending a response to the microcomputer, any GOT-F900 unit cannot receive any new command from the microcomputer.

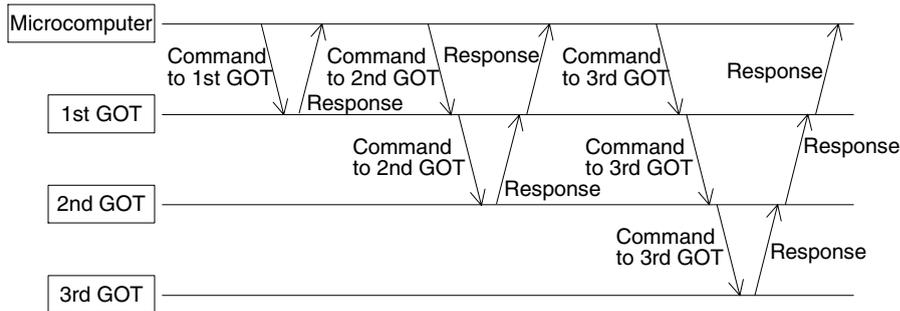

If an error occurs, the GOT-F900 returns the NAK code as the response. The contents of the error can be seen when the special memory is read.

#### 2) Outline of interrupt

As an exception of the communication procedure described above, when a certain event occurs in itself or receiving an interrupt code from another GOT unit, the GOT unit immediately sends the interrupt code to the microcomputer.

However, while sending a response to the microcomputer, the GOT unit waits until sending is finished, then sends the interrupt code after that. An interrupt code may be sent while a command is being received.

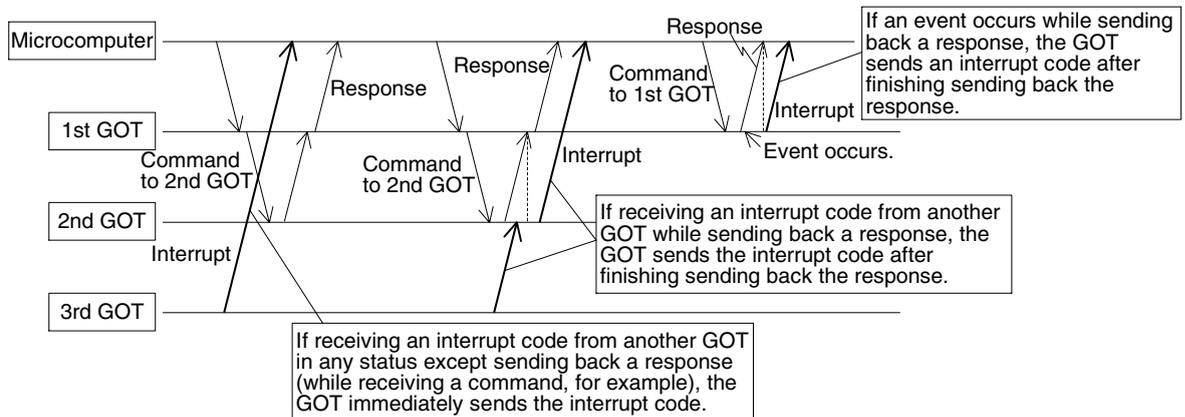

If an event such as change of the ON/OFF status of a certain bit data or a screen changeover occurs by a touch key on the screen, an interrupt code is sent.

### 14.5.2 Command List and Compatible Version of GOT-F900

The table below explains commands used to transfer data between the GOT-F900 and the microcomputer.

Command list

Command	Command name	Description	Reference
'0' 30H	Batch read command	Consecutively reads data by as much as the specified number of points from the specified device.	14.6.1
'A' 41H		To the command above, specification with the station number is added. <Available in versions in which connection of two or more GOT units is enabled.>	
'1' 31H	Batch write command	Consecutively writes data by as much as the specified number of points to the specified device.	14.6.2
'B' 42H		To the command above, specification with the station number is added. <Available in versions in which connection of two or more GOT units is enabled.>	
'3' 33H	Bit-oriented write command	Write specified bit device in a byte unit according to a pattern	14.6.3
'D' 44H			
'4' 34H	Fill command	Write specified data to all the devices between specified data and specified data	14.6.4
'E' 45H			

Compatible version of GOT-F900

	F920GOT-K 24V type	F930GOT	F930GOT-K	F940GOT	F940WGOT	Handy GOT
Batch read command	Ver1.20	Ver1.00	Ver4.60	Ver1.00	Ver1.00	Ver1.00
Batch write command	Ver1.20	Ver1.00	Ver4.60	Ver1.00	Ver1.00	Ver1.00
Bit-oriented write command	Ver1.20	Ver4.50	Ver4.60	Ver6.50	Ver1.50	Ver6.50
Fill command	Ver1.20	Ver4.50	Ver4.60	Ver6.50	Ver1.50	Ver6.50

### 14.5.3 Data Transfer Format (protocol)

The table below explains the data transfer formats (protocols) 1 and 2 when commands are used.

Selected protocol		Format 1				Format 2				
Format while data is transmitted (microcomputer → GOT)	1:1	STX (02H)	Command '0' 30H '1' 31H '3' 33H '4' 34H	Data	CR (0DH)	STX (02H)	Command '0' 30H '1' 31H '3' 33H '4' 34H	Data	ETX (03H)	Sum check
	Two or more GOT units	<Available in versions in which connection of two or more GOT units is enabled>				<Available in versions in which connection of two or more GOT units is enabled>				
Format of response data in normal status (GOT → microcomputer)	When read command is transmitted	STX (02H)	Data	CR (0DH)	STX (02H)	Command 'A' 41H 'B' 42H 'D' 44H 'E' 45H	Station No.	Data	ETX (03H)	Sum check
	When write command is transmitted					ACK (06H)				
Format of response data when error has occurred (GOT → microcomputer)						NAK (15H)				
Format of interrupt output (GOT → microcomputer)						Interrupt output data				

### 14.5.4 Character Code List

The following characters are available in statements. Interrupt codes include unused codes.

	Character code (hexadecimal)
STX	02H
ETX	03H
CR	0DH
ACK	06H
NAK	15H
'0'~'9'	30~39H
'A'~'F'	41~46H

	Character code (hexadecimal)
Interrupt code	20~2FH
	50~7FH
	80F~FFH (Valid only when data length is 8 bits)

### 14.5.5 Station Number Setting

#### When connecting two or more GOT units

When connecting two or more GOT units to the microcomputer, add a station No. (01 to 31 in decimal) to the command of the microcomputer ("A" to "E") in two bytes, then set the station No. (DST STATION#) in the screen creation software or in the GOT. Do not assign a same No. to two or more GOT units. No setting for GOT STATION# is required. (It is 0.)

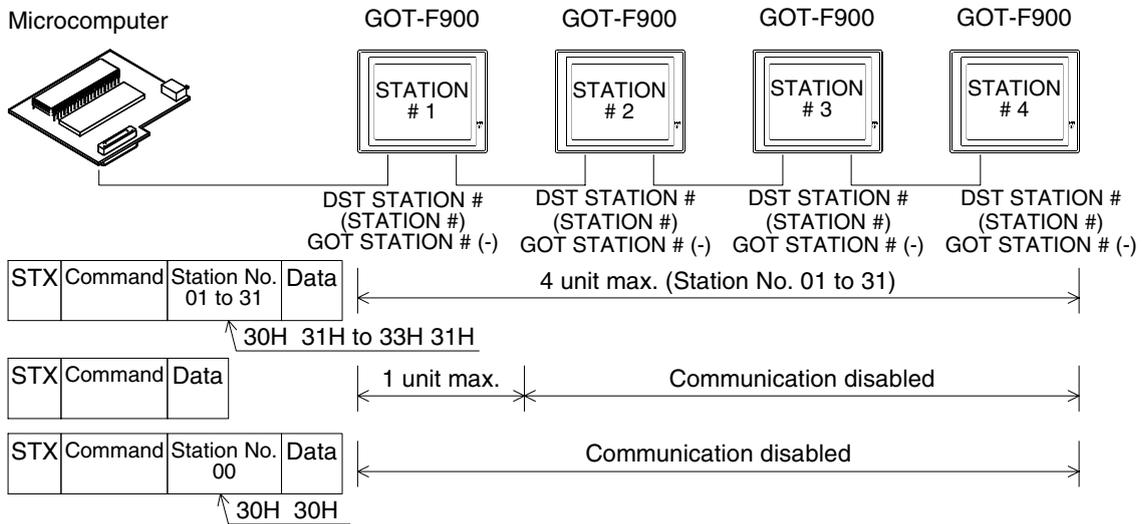

#### When connecting on the 1:1 basis

When connecting one GOT unit to the microcomputer, it is not required to add a station No. to the command ("0" to "4"). Set 0 to the station No. (DST STA #) in the screen creation software or in the GOT. No setting for GOT STATION# is required. (It is 0.)

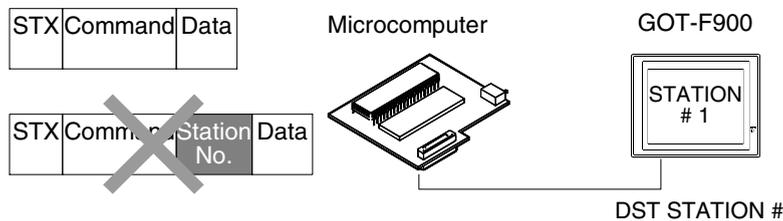

### 14.5.6 Sum Check Code

The sum check code indicates the numeric value of the lower 1 byte (8 bits) of the result obtained when the data in the sum check range is added as the binary data (sum).

Example: When the batch read command is executed for the used address "100" (D50)

STX	Address				Number of points	ETX	Sum check		
0	0	0	1	0	0	2	5	6	
(02H)	(30H)	30H	31H	30H	30H	30H	32H	03H	35H 36H

Sum check range

Expression: 30H+30H+31H+30H+30H+30H+32H+03H=156H

### 14.5.7 Interrupt Code List

The table below shows the correspondence between interrupt codes and event types.

Interrupt code (hexadecimal)	Event type
20H	The screen is changed over.
21H	Input of a numeric value is completed.
22H	Transfer of a data file is completed.
23H	Read of bar code data is completed.
50H	M8000 has changed to ON.
51H	M8000 has changed to OFF.
52H	M8001 has changed to ON.
53H	M8001 has changed to OFF.
:	:
7EH	M8023 has changed to ON.
7FH	M8023 has changed to OFF.
:	:
B2H	M8049 has changed to ON.
B3H	M8049 has changed to OFF.

11

Connection of  
MELSEC-Q  
Series PLC

12

Connection of  
FX Series  
Positioning

13

Connection of  
FREQROL  
Inverter

14

Connection of  
Microcom-  
puter

15

Connection of  
SYSMAC C  
Series PLC

16

Connection of  
FLEX-PC N  
Series PLC

17

Connection of  
Machine Con-  
troller

18

Connection of  
FP Series PLC

19

Connection of  
SLC500  
Series PLC

20

Connection of  
SIMATIC S7  
Series PLC

### 14.6 Command Details

This section explains the format of each command using examples.

#### 14.6.1 Batch Read Command

The contents of the batch read command are explained below as an example of the format 2.

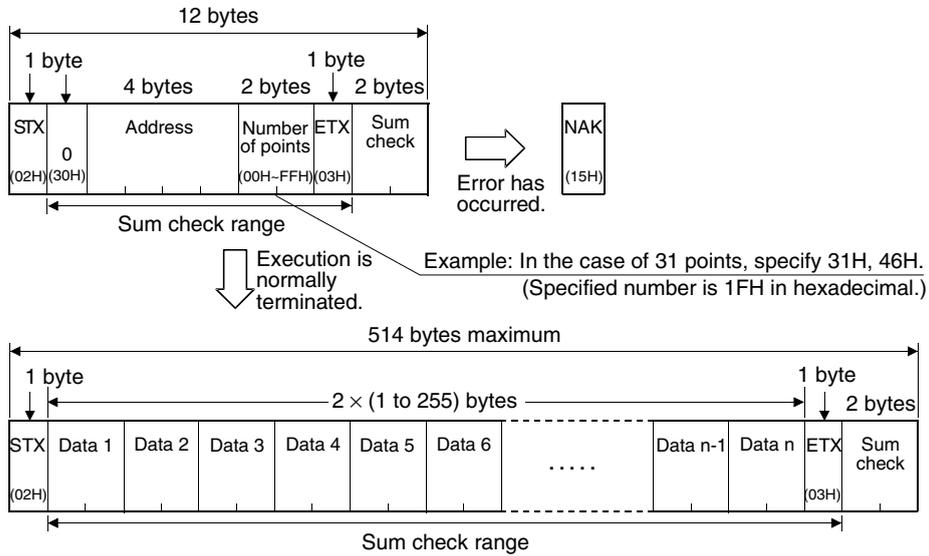

#### Use Example

When virtual devices D100 to D102 of the GOT-900 are read.

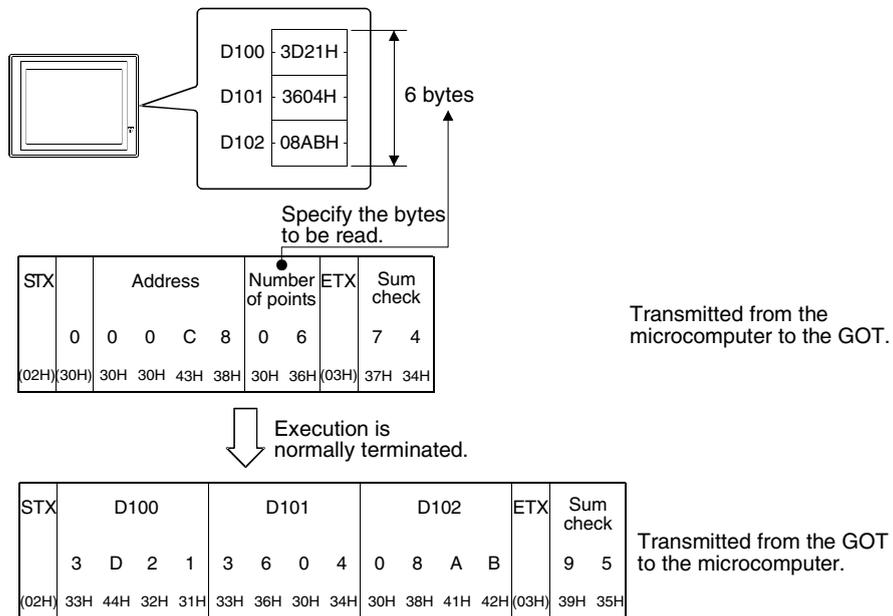

### 14.6.2 Batch Write Command

The contents of the batch write command are explained below as an example of the format 2.

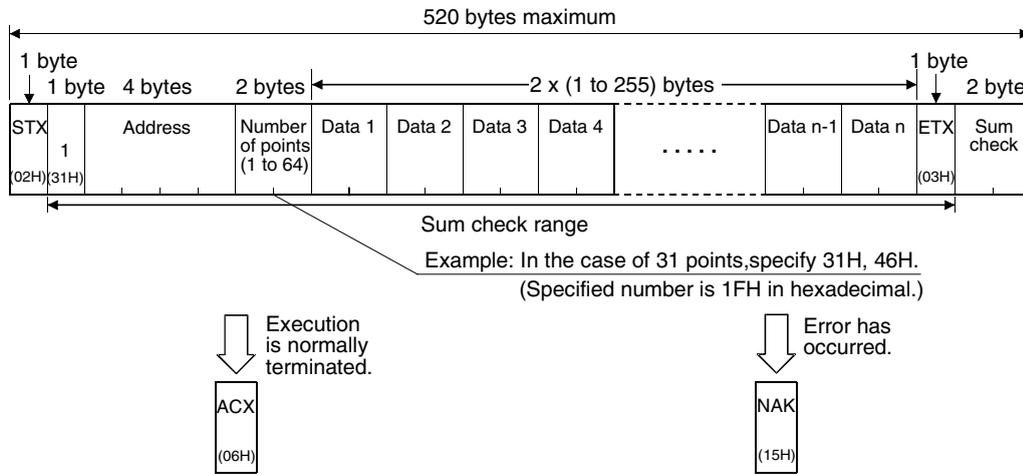

#### Use Example

When "64H" and "65H" are written respectively to virtual devices D100 and D101 of the GOT-F900.

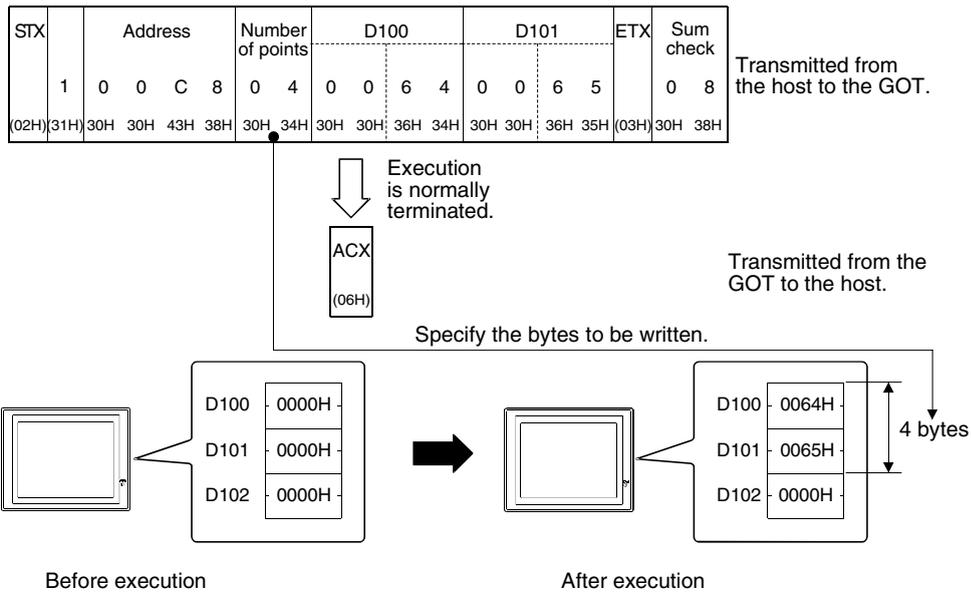

### 14.6.3 Bit-oriented Write Command

The contents of bit-oriented write command are explained below as an example of the format 2.

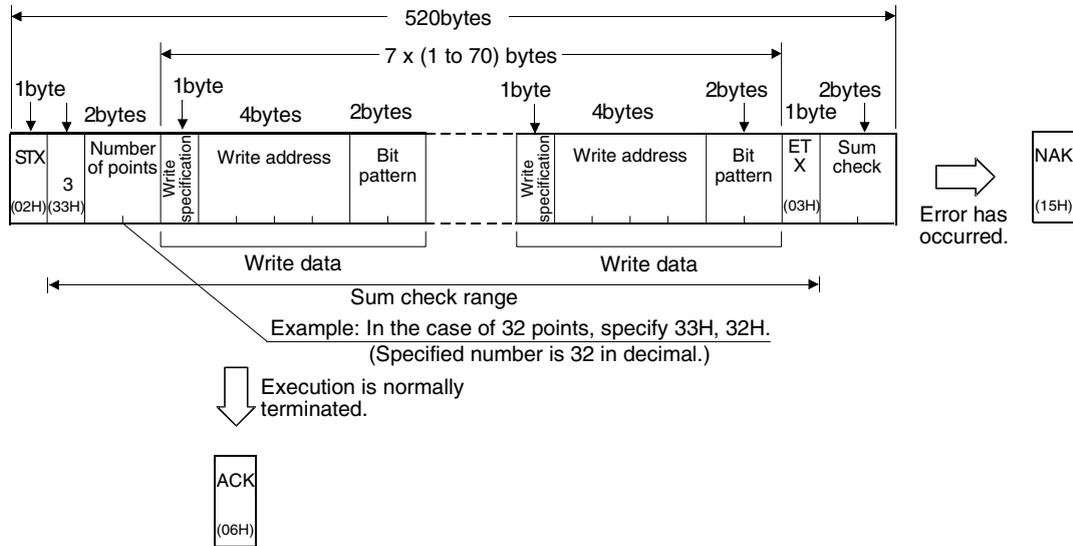

#### Specification of write data

Up to 70 points of write data can be specified per command. One portion of write data is shown below.

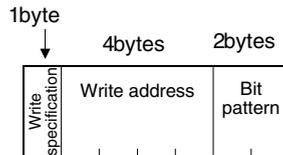

#### 1) Write specification

The address data specified by the write address and the value specified by the bit pattern determine how the change should be.

Function	Write specification	Specification	Example
ON specification	0(30H)	Set '1' for the bit to turn ON with the bit pattern. Set '0' for the bit not to change.	Original data 1 0 1 0 Bit pattern 1 1 0 0 Result 1 1 1 0
OFF specification	1(31H)	Set '1' for the bit to turn OFF with the bit pattern. Set '0' for the bit not to change.	Original data 1 0 1 0 Bit pattern 1 1 0 0 Result 0 0 1 0
Reverse specification	2(32H)	Set '1' for the bit to reverse with the bit pattern. Set '1' for the bit not to change.	Original data 1 0 1 0 Bit pattern 1 1 0 0 Result 0 1 1 0
Write specification	3(33H)	Set the numerical value to write with the bit pattern.	Original data 1 0 1 0 Bit pattern 1 1 0 0 Result 1 1 0 0



**2) Write address**

The address of bit device or word device (hexadecimal) is specified to write.

**3) Bit pattern**

The bit pattern is specified to change.

(The pattern expressed in 1 byte is set to a 2byte ASCII code.)

**Use example**

In case only M30 bit in the GOT-F900 virtual device is set ON by ON specification

STX	Number of points		Write specification	Write address				Bit pattern	ETX	Sum check	
	3	0 1	0	2	0	0	3	4 0		6	7
(02H)	(33H)	(30H)(31H)	(30H)	(32H)	(30H)	(30H)	(33H)	(34H)(30H)	(03H)	36H	37H

Transmitted from the microcomputer to the GOT.

↓ Execution is normally terminated.

ACK  
(06H)

↓ Error has occurred.

ACK  
(06H)

Transmitted from the GOT to the microcomputer.

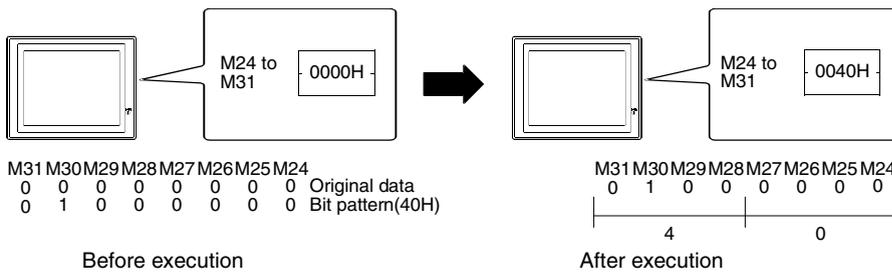

11 Connection of MELSEC-Q Series PLC

12 Connection of FX Series Positioning

13 Connection of FREQROL Inverter

14 Connection of Microcomputer

15 Connection of SYSMAC C Series PLC

16 Connection of FLEX-PC N Series PLC

17 Connection of Machine Controller

18 Connection of FP Series PLC

19 Connection of SLC500 Series PLC

20 Connection of SIMATIC S7 Series PLC

### 14.6.4 Fill Command

The contents of fill command are explained below as an example of the format 2.

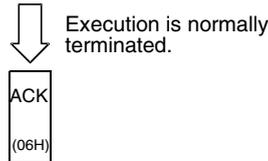
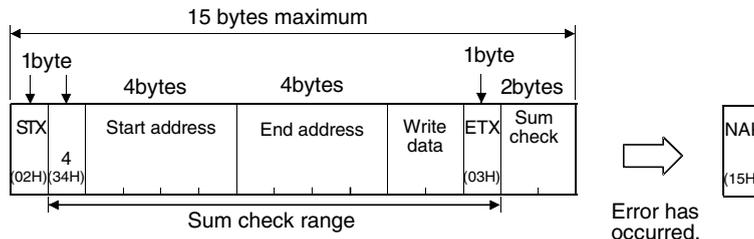

#### Use example

When "77H" is written to virtual devices D100 (H) through D120 (L) of the GOT-F900.

STX	Address	Address	Write data	ETX	Sum check
4	0 0 C 8	0 0 F 1	7 7	7 7	5 7
(02H)(34H)	30H 30H 43H 38H	30H 30H 46H 31H	37H 37H	(03H)	35H 37H

Transmitted from the microcomputer to the GOT.

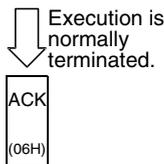

Transmitted from the GOT to the microcomputer.

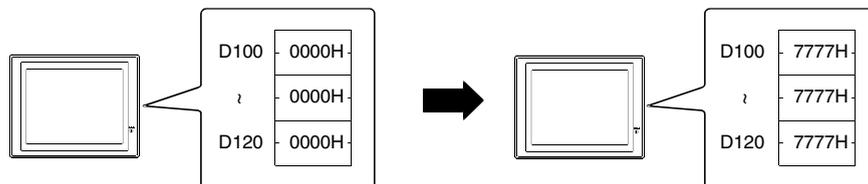

Before execution

After execution

#### Specification of start address and end address

Specify the address so that 'Start address ≤ End address'.

If 'Start address > End address' or either address is over GB1023, an error (NAK) is sent back.

### 14.6.5 Interrupt Code

The interrupt code is explained in the example below.

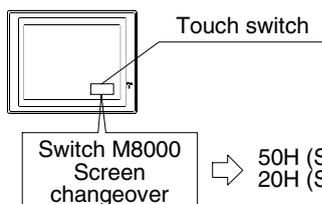

#### Use example

When the touch switch on the GOT-F900 is pressed, the interrupt code for the switch and screen changeover is output.

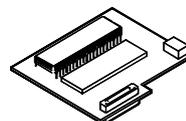

## 14.7 Caution on Use of Microcomputer Connection

When using the GOT-F900 connected to the microcomputer, observe the following caution on use.

### 14.7.1 When Using F920GOT-K



Only the F920GOT-K (24 V type) can be connected.  
The following device range can be monitored.

		Other than F920GOT-K (24 V type)	F920GOT-K (24V type)
Word device	Word data (D)	D0 to D4095 (4,096 points)	D0 to D1023 (1,024 points)

11

Connection of  
MELSEC-Q  
Series PLC

12

Connection of  
FX Series  
Positioning

13

Connection of  
FREQROL  
Inverter

14

Connection of  
Microcom-  
puter

15

Connection of  
SYSMAC C  
Series PLC

16

Connection of  
FLEX-PC N  
Series PLC

17

Connection of  
Machine Con-  
troller

18

Connection of  
FP Series PLC

19

Connection of  
SLC500  
Series PLC

20

Connection of  
SIMATIC S7  
Series PLC

### 14.8 Setting of Connected Equipment for GOT

The setting for connection to the microcomputer can be executed using the GOT-F900 and the screen creation software (GT Designer2, GT Designer or DU/WIN).

#### 1) GOT-F900 Series

When the main menu screen change operation is disabled.

Operation	Display (screen name)
a) While pressing and holding the upper left corner of the screen, turn on the power. Keep holding the upper left corner for about 25 seconds more. Then, press "END" at the upper right corner. b) Press "PLC TYPE". c) Set the following. PLC TYPE: UNIVERSAL CONNECTION: CPU PORT (RS-422) CPU PORT (RS-232C) DST STATION # (STATION #) : 00(01 to 31 when two or more GOTs are connected) GOT STATION # (-) : -	The "LANGUAGE" screen appears.  The "SET-UP MODE" screen appears. The "PLC TYPE" screen appears.

When the main menu screen change operation is enabled.

Operation	Display (screen name)
a) Press the upper left corner of the screen. (The position to be pressed can be changed in the GOT and the screen creation software.) b) Press "OTHER MODE" on the menu. c) Press "SET-UP MODE" on the menu. d) Press "PLC TYPE". e) Set the following. PLC TYPE: UNIVERSAL CONNECTION: CPU PORT (RS-422) CPU PORT (RS-232C) DST STATION # (STATION #) : 00(01 to 31 when two or more GOTs are connected) GOT STATION # (-) : -	The "SELECT MODE" screen appears.  The "OTHER MODE" screen appears. The "SET-UP MODE" screen appears. The "PLC TYPE" screen appears.

Set the transmission specifications consecutively.



Setting the transmission specifications for microcomputer connection

Operation	Display (screen name)
a) While pressing and holding the upper left corner of the screen, turn on the power. Keep holding the upper left corner for about 25 seconds more. Then, press "END" at the upper right corner. b) Press "SERIAL PORT". Set the transmission specifications as in the microcomputer. Make sure to set a printer to "DON'T USE".	The "LANGUAGE" screen appears.  The "SET-UP MODE" screen appears. The "SERIAL PORT" screen appears.

- When the screen data is transferred to the GOT-F900, the old data including the PLC type, connection type, and station number are overwritten.

2) GT Designer2

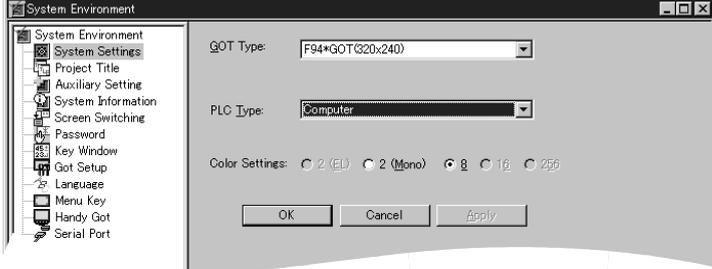
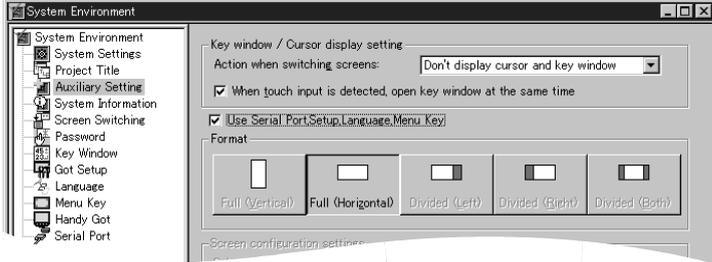
	Operation	Display (screen name)										
[Creation]	<p>a) Open GT Designer2.</p> <p>b) Click the [NEW] button. The dialog box shown below is displayed. If it is not displayed, click "System Environment" in the tree displayed in the project work space, then click "System settings" in the tree.</p>  <p>c) Set the following. GOT type: F940WGOT (480 × 234) &lt;WIDE&gt; F94*GOT (320 × 240) F93*GOT (240 × 80) F920GOT (128 × 64) PLC type: Computer Selection of "GOT type"</p> <table border="1" data-bbox="483 1039 1114 1285"> <thead> <tr> <th>GOT type</th> <th>Model name (name)</th> </tr> </thead> <tbody> <tr> <td>F940WGOT(480×234)&lt;WIDE&gt;</td> <td>F940WGOT</td> </tr> <tr> <td>F94*GOT(320×240)</td> <td>F940GOT Handy GOT</td> </tr> <tr> <td>F93*GOT(240×80)</td> <td>F930GOT F930GOT-K</td> </tr> <tr> <td>F920GOT (128 × 64)</td> <td>F920GOT-K (24V)</td> </tr> </tbody> </table> <p>Click [OK].</p> <p>d) Setting the port (RS-422 or RS-232C) of the GOT-F900 Click "Auxiliary Setting" in the tree of the system environment menu. Click the check box of "Use Serial Port, Setup, Language, Menu Key" to give a check mark (✓).</p> 	GOT type	Model name (name)	F940WGOT(480×234)<WIDE>	F940WGOT	F94*GOT(320×240)	F940GOT Handy GOT	F93*GOT(240×80)	F930GOT F930GOT-K	F920GOT (128 × 64)	F920GOT-K (24V)	<p>The "Select Project" dialog box appears.</p> <p>The "System Environment" dialog box appears.</p> <p>The "Setting" dialog box appears.</p>
GOT type	Model name (name)											
F940WGOT(480×234)<WIDE>	F940WGOT											
F94*GOT(320×240)	F940GOT Handy GOT											
F93*GOT(240×80)	F930GOT F930GOT-K											
F920GOT (128 × 64)	F920GOT-K (24V)											

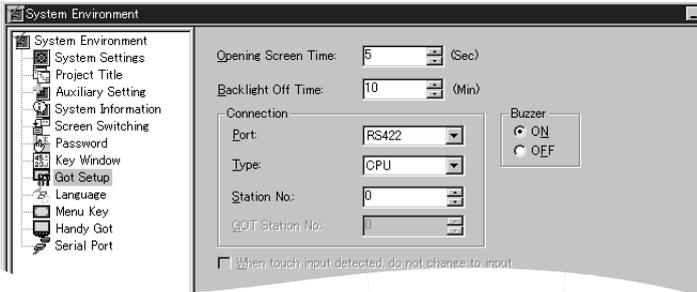
Operation		Display (screen name)							
	<p>Click "Got Setup" in the tree of the system environment menu.</p>  <p>e) Set the following.</p> <p>Port : RS-422 RS-232C</p> <p>Type : CPU</p> <p>Station No. : 00 (01 to 31 when two or more GOTs are connected)</p> <p>GOT Station No. : -</p> <p><u>In the case of F943 Handy GOT</u> Without regard to the port setting (RS-422 or RS-232C), the COM0 side of the RS-232C is fixed for PLC connection. Combinations of "Port" and "Type" are as follows.</p> <table border="1" data-bbox="472 954 922 1117"> <thead> <tr> <th>Port</th> <th>Type</th> </tr> </thead> <tbody> <tr> <td rowspan="2">RS-422</td> <td>CPU</td> </tr> <tr> <td>LINK</td> </tr> <tr> <td>RS-232C</td> <td>LINK</td> </tr> </tbody> </table>	Port	Type	RS-422	CPU	LINK	RS-232C	LINK	
Port	Type								
RS-422	CPU								
	LINK								
RS-232C	LINK								
[Change method]	<p>Change the connection type of the already created data as follows.</p> <p>a) Open GT Designer2.</p> <p>b) Click the [Project]-[Open] button.</p> <p>c) Open (read) the screen data to be changed.</p> <p>d) On the menu, select "Common"-[System Environment].</p> <ul style="list-style-type: none"> <li>- For the contents of setting, refer to c) of [Creation] above.</li> <li>- For selection of the RS-422 or the RS-232C on the Microcomputer, refer to e) of [Creation] above.</li> </ul>	<p>The "Select Project" dialog box appears.</p> <p>The "System Environment" dialog box appears.</p>							

Set the transmission specifications consecutively.

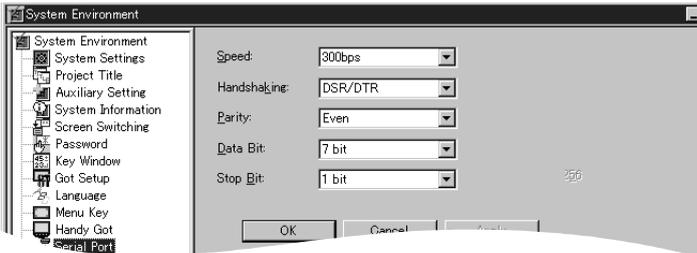

Setting the transmission specifications for microcomputer connection

Operation		Display (screen name)
[Creation]	<p>a) Click "Serial Port" in the tree of the [Common]-[System Environment] menu.</p>  <p>b) Set the transmission specifications set in the microcomputer. Set "Speed", "Parity", "Data Bit" and "Stop Bit". (Handshaking not available)</p>	<p>The "System Environment" dialog box appears.</p>

3) GT Designer

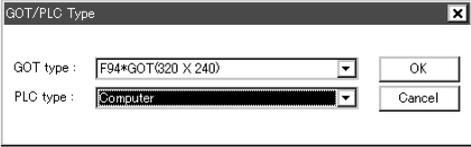
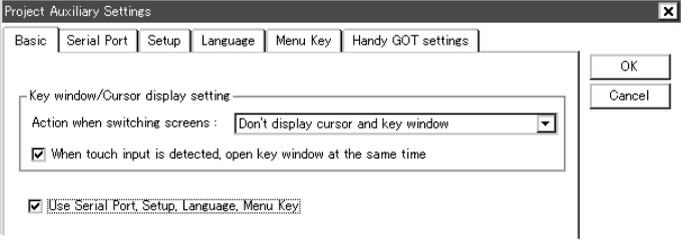
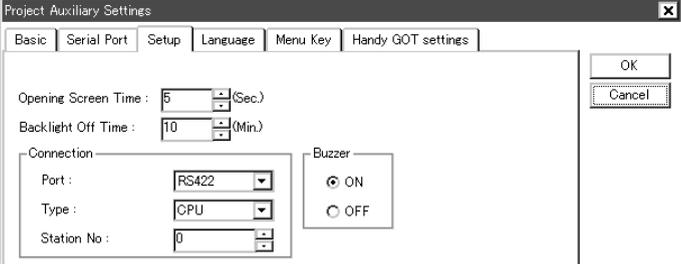
	Operation	Display (screen name)								
[Creation]	<p>a) Open GT Designer.</p> <p>b) Click the [New] button.</p>  <p>c) Set the following.                      GOT type: F940WGOT (480 × 234) &lt;WIDE&gt;                      F94*GOT (320 × 240)                      F93*GOT (240 × 80)                      PLC type: Computer                      Selection of "GOT type"</p> <table border="1" data-bbox="497 763 1106 972"> <thead> <tr> <th>GOT type</th> <th>Model name</th> </tr> </thead> <tbody> <tr> <td>F940WGOT(480×234)&lt;WIDE&gt;</td> <td>F940WGOT</td> </tr> <tr> <td>F94*GOT(320×240)</td> <td>F940GOT Handy GOT</td> </tr> <tr> <td>F93*GOT(240×80)</td> <td>F930GOT-K F930GOT</td> </tr> </tbody> </table> <p>Click [OK].</p> <p>d) Set CPU direct connection (RS-422/RS-232C) of the GOT-F900.                      This setting is enabled in the SW4D5C-GOTR-PACKE version A or later.                      Click the check box of "Use Serial Port, Setup, Language, Menu Key" to give a check mark (✓).</p>  <p>Click the "Setup" tab.</p> 	GOT type	Model name	F940WGOT(480×234)<WIDE>	F940WGOT	F94*GOT(320×240)	F940GOT Handy GOT	F93*GOT(240×80)	F930GOT-K F930GOT	<p>The "Select Project" dialog box appears.</p> <p>The "GOT/PLC Type" dialog box appears.</p> <p>The "Project Auxiliary Settings" dialog box appears.</p>
GOT type	Model name									
F940WGOT(480×234)<WIDE>	F940WGOT									
F94*GOT(320×240)	F940GOT Handy GOT									
F93*GOT(240×80)	F930GOT-K F930GOT									

11 Connection of MELSEC-Q Series PLC

12 Connection of FX Series Positioning

13 Connection of FREQROL Inverter

14 Connection of Microcomputer

15 Connection of SYSMAC C Series PLC

16 Connection of FLEX-PC N Series PLC

17 Connection of Machine Controller

18 Connection of FP Series PLC

19 Connection of SLC500 Series PLC

20 Connection of SIMATIC S7 Series PLC

Operation		Display (screen name)
	<p>In the case of SW4D5C-GOTR-PACKE earlier than version A, perform the setting in the GOT-F900. (Set the connection in "CONNECTION" in the GOT-F900.) For the setting method, refer to "1) GOT-F900 Series" on the previous page.</p> <p>e) Set the following.</p> <p>Port : RS-422 RS-232C</p> <p>Type : CPU</p> <p>DST Station No. (Station No.): 00 (01 to 31 when two or more GOTs are connected)</p> <p>GOT Station No. (-) : -</p>	
[Change method]	<p>Change the connection type of the already created data as follows.</p> <p>a) Open GT Designer.</p> <p>b) Click the [New] button.</p> <p>c) Open (read) the screen data to be changed.</p> <p>d) On the menu, select "Common"-&gt;"GOT/PLC Type". - For the contents of setting, refer to c) of [Creation] above. - For selection of the RS-422 or the RS-232C on the Microcomputer, refer to e) of [Creation] above.</p>	<p>The "Select Project" dialog box appears.</p> <p>The "GOT/PLC Type" dialog box appears.</p>

Set the transmission specifications consecutively.

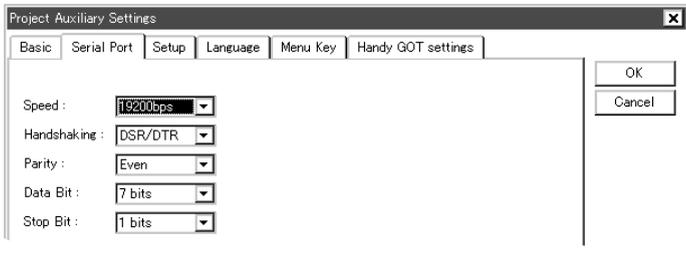

Setting the transmission specifications for microcomputer connection

Operation		Display (screen name)
[Creation]	<p>a) On the menu, select "Common"-&gt;"Auxiliary Setting"-&gt;"Project"-&gt;"Serial Port".</p>  <p>b) Set the transmission specifications set in the microcomputer. Set "Speed", "Parity", "Data Bit" and "Stop Bit". (Handshaking not available)</p>	<p>The "Project Auxiliary Settings" dialog box appears.</p>

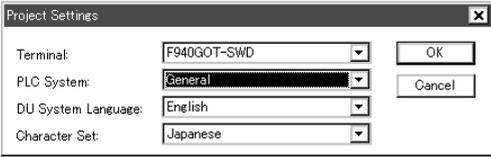
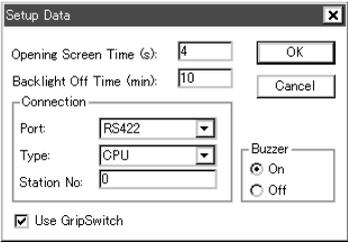

4) DU/WIN

	Operation	Display (screen name)										
[Creation]	<p>a)Open DU/WIN.</p> <p>b)On the menu, select "File"- "New".</p>  <p>c)Set the following.                      Terminal: F940WGOT-TWD (V) (H)                      F940GOT-LWD                      F940GOT-SWD                      F930GOT-BWD (V) (H)                      PLC System: MELSEC-QnA, Q</p> <p>Select "Terminal" in accordance with the LC display color.</p> <table border="1" data-bbox="464 819 1134 1111"> <thead> <tr> <th>Terminal</th> <th>Model name</th> </tr> </thead> <tbody> <tr> <td>F940WGOT-TWD (V)(H)</td> <td>F940WGOT (color)</td> </tr> <tr> <td>F940GOT-LWD</td> <td>F940GOT (black and white) Handy GOT (black and white)</td> </tr> <tr> <td>F940GOT-SWD</td> <td>F940GOT (color) Handy GOT (color)</td> </tr> <tr> <td>F930GOT-BWD (V)(H)</td> <td>F930GOT-K (blue) F930GOT (blue)</td> </tr> </tbody> </table> <p>d)Set CPU direct connection (RS-422/RS-232C) of the GOT-F900.                      On the menu, select "View/Project"- "System Settings"- "Setup Data".</p>  <p>e)Set the following.                      Port: RS-422                      RS-232C                      Type: CPU                      DST Station No. (Station No.): 00 ((01 to 31 when two or more GOTs are connected))                      GOT Station No. (-) : -</p>	Terminal	Model name	F940WGOT-TWD (V)(H)	F940WGOT (color)	F940GOT-LWD	F940GOT (black and white) Handy GOT (black and white)	F940GOT-SWD	F940GOT (color) Handy GOT (color)	F930GOT-BWD (V)(H)	F930GOT-K (blue) F930GOT (blue)	<p>The "Project settings" dialog box appears.</p> <p>The "Setup Data" dialog box appears.</p>
Terminal	Model name											
F940WGOT-TWD (V)(H)	F940WGOT (color)											
F940GOT-LWD	F940GOT (black and white) Handy GOT (black and white)											
F940GOT-SWD	F940GOT (color) Handy GOT (color)											
F930GOT-BWD (V)(H)	F930GOT-K (blue) F930GOT (blue)											
[Change method]	<p>Change the connection type of the already created data as follows.</p> <p>a)Open DU/WIN.</p> <p>b)On the menu, select "File"- "Open".</p> <p>c)Select and open (read) the file of the screen data to be changed.</p> <p>d)When changing "Terminal" (GOT-F900), select "View/Project"- "System Settings"- "Project settings" on the menu.                      - For the contents of setting, refer to c) of [Creation] above.                      - For selection of the RS-422 or the RS-232C on the Microcomputer, refer to e) of [Creation] above.</p>	<p>The "Open" dialog box appears.</p>										

Set the transmission specifications consecutively.

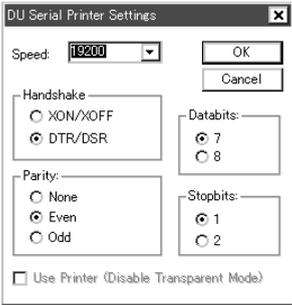

Setting the transmission specifications for microcomputer connection

Operation		Display (screen name)
[Creation]	<p>a) On the menu, select "View/Project"-&gt;"System Settings"-&gt;"DU-Printer".</p>  <p>b) Set the transmission specifications set in the microcomputer. Set "Speed", "Parity", "Databits" and "Stopbits". (Handshake not available)</p>	<p>The "DU Serial Printer Settings" dialog box appears.</p>

### 14.9 Cable Diagram

This section explains cable diagrams to connect the GOT-F900 and the general-purpose equipment (microcomputer).

#### 14.9.1 Cautions on preparing cables

1) When preparing the cables, use the wire size of 0.08mm<sup>2</sup> or more (AWG28 or more) for communication, 0.3mm<sup>2</sup> or more (AWG22 or more) for the power supply, operation switch, and emergency stop switch.

2)  stands for a twisted pair cable. Prepare a twisted pair cable in combination of the pin numbers and signal lines described on the cable diagram.

Do not use a twisted pair cable with the power supply wire and the communication wire.

#### 14.9.2 Cable diagram

##### 1) Cable for the GOT and the microcomputer

 : Female type   
  : Male type   
 The connector figure shows the engagement face.

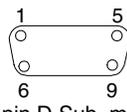
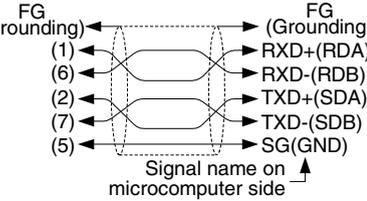
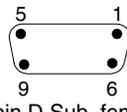
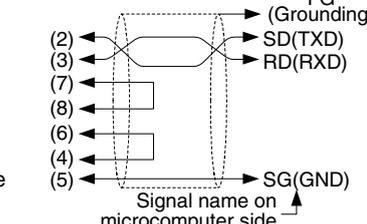
No.	Model name	Application	Connection diagram	Application
a)	General-purpose equipment Prepared by the user RS-422 connection	To GOT-F900  9-pin D-Sub, male		To microcomputer side
b)	Prepared by the user RS-232C connection	To GOT-F900  9-pin D-Sub, female		To microcomputer side *1

\*1 Control lines RTS, CTS, DTR and DSR are not used.

##### 2) Cable for the Handy GOT and the microcomputer

When using the Handy GOT RH model, refer to the cable diagrams below for the RS-422/RS-232C connector, but not the wiring for the power supply, the operation switches, and the emergency stop switch because it is different. For details, refer to Section 5.18.

 : Female type   
  : Male type   
 The connector figure shows the engagement face.

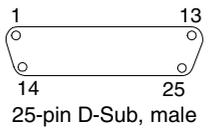
No.	Model name	Application	Connection diagram	Application
a)	F9GT-HCAB-3M F9GT-HCAB-10M RS-422 connection RS-232C connection	Dedicated connector on Handy GOT side	The connector on the leader side of the Handy GOT is dedicated, and cannot be prepared by the user.	To F9GT-HCAB3-150  25-pin D-Sub, male
b)	F9GT-HCAB1-3M F9GT-HCAB1-10M RS-422 connection RS-232C connection	Dedicated connector on Handy GOT side	The connector on the leader side of the Handy GOT is dedicated, and cannot be prepared by the user.	Loose wires (no connector)

11 Connection of MELSEC-Q Series PLC

12 Connection of FX Series Positioning

13 Connection of FREQROL Inverter

14 Connection of Microcomputer

15 Connection of SYSMAC C Series PLC

16 Connection of FLEX-PC N Series PLC

17 Connection of Machine Controller

18 Connection of FP Series PLC

19 Connection of SLC500 Series PLC

20 Connection of SIMATIC S7 Series PLC

Female type Male type The connector figure shows the engagement face.

No.	Model name	Application	Connection diagram	Application
c)	General-purpose equipment Prepared by the user	RS-422 connection	<p>Wiring according to the pin number of F9GT-HCAB-□□□M</p> <p>Drain wire (1) → FG (Grounding)</p> <p>To cable F9GT-HCAB or F9GT-HCAB1 on Handy GOT side</p> <p>Signal name on microcomputer side</p> <p>PL (12) → DC24VG PK (13) → DC24VG LTGR (14) → SW-COM / ES1-2 SB (15) → SW1 / DSW2 BK/W (16) → SW2 / DSW2 R/W (17) → SW3 / DSW1 GR/W (18) → SW4 / DSW1 O/W (20) → / ES1-2 Y/W (21) → ES1 / ES1-1 BR/W (22) → ES1 / ES1-1 BL/W (24) → DC24V+ GY/W (25) → DC24V+</p> <p>Wiring according to the wire color of F9GT-HCAB1-□□□M</p> <p>Old cable description → New cable description</p>	To microcomputer side
d)	Prepared by the user	RS-232C connection	<p>Wiring according to the pin number of F9GT-HCAB-□□□M</p> <p>Drain wire (1) → FG (Grounding)</p> <p>To cable F9GT-HCAB or F9GT-HCAB1 on Handy GOT side</p> <p>Signal name on microcomputer side</p> <p>PL (12) → DC24VG PK (13) → DC24VG LTGR (14) → SW-COM / ES1-2 SB (15) → SW1 / DSW2 BK/W (16) → SW2 / DSW2 R/W (17) → SW3 / DSW1 GR/W (18) → SW4 / DSW1 O/W (20) → / ES1-2 Y/W (21) → ES1 / ES1-1 BR/W (22) → ES1 / ES1-1 BL/W (24) → DC24V+ GY/W (25) → DC24V+</p> <p>Wiring according to the wire color of F9GT-HCAB1-□□□M</p> <p>Old cable description → New cable description</p>	To microcomputer side <sup>*1</sup>
e)	General-purpose equipment Prepared by the user	RS-422 connection	<p>Wiring according to the pin number of F9GT-HCAB-□□□M</p> <p>FG (Grounding) (1) → FG (Grounding)</p> <p>To F9GT-HCNB 9-pin D-Sub, male</p> <p>Signal name of microcomputer</p> <p>FG (Grounding) (5) → FG (Grounding)</p> <p>1 (2) → RXD+(RDA) 5 (3) → RXD-(RDB) 6 (4) → TXD+(SDA) 9 (7) → TXD-(SDB) 5 (8) → SG(GND)</p>	To microcomputer side

\*1 Control lines RTS, CTS, DTR and DSR are not used.

## 14.10 Troubleshooting

For reference, this section summarizes frequently asked questions about connection of the GOT-F900 to the microcomputer.

### 1) GOT-F900

Contents of trouble	Check points and countermeasures	OS version		
		F940W	F940	F930
"COMMUNICATION ERROR OCCURS" is displayed when a screen changeover or numeric data input is performed on the GOT-F900 screen.	The power of the microcomputer is turned off. <ul style="list-style-type: none"> <li>• Cause Communication is disabled because the power of the microcomputer is turned off.</li> <li>• Countermeasures Turn on the power.</li> </ul>	From first product	From first product	From first product
	Something is wrong with the cable between the GOT-F900 and the microcomputer. <ul style="list-style-type: none"> <li>• Causes The wrong cable is used or the connection is bad.</li> <li>• Countermeasures Check the cable.</li> </ul>			
"DISPLAY SCREEN IS NOT AVAILABLE." is displayed on the GOT-F900 screen.	Changeover to a nonexistent screen by a touch key or the microcomputer was tried. <ul style="list-style-type: none"> <li>• Cause The changeover destination screen has not been created yet.</li> <li>• Countermeasures Create the screen.</li> </ul>	–	Earlier than 6.00	Earlier than 4.00
"DISPLAY SCREEN IS NOT AVAILABLE. (NO. #####)" is displayed on the GOT-F900 screen.	A nonexistent screen was tried to be displayed. <ul style="list-style-type: none"> <li>• Cause The screen No. ##### has not been created yet.</li> <li>• Countermeasures Create the screen.</li> </ul>	From first product	6.00 or later	4.00 or later
"DISPLAY SCREEN IS NOT AVAILABLE." is displayed on the GOT-F900 screen.	There is an error on the screen to be displayed. <ul style="list-style-type: none"> <li>• Cause One of the screen objects is placed outside the available screen area.</li> <li>• Countermeasures Check the placement of screen objects.</li> </ul>	–	Earlier than 6.00	Earlier than 4.00
"DISPLAY SCREEN IS NOT AVAILABLE. (NO. #####)" is displayed on the GOT-F900 screen.		From first product	6.00 or later	4.00 or later
"DATA IS NOT FOUND." is displayed on the GOT-F900 screen.	There is not data because the unit is new or the memory clear has been executed. <ul style="list-style-type: none"> <li>• Cause There is no screen data.</li> <li>• Countermeasures Write the screen data using the screen creation software.</li> </ul>	From first product	From first product	From first product
"CAN NOT WRITE TO PLC MEMORY." is displayed on the GOT-F900 screen.	This error is not displayed.	Earlier than 1.10	Earlier than 6.10	Earlier than 4.10
"CAN NOT WRITE." is displayed on the GOT-F900 screen.	This error is not displayed.	1.10 or later	6.10 or later	4.10 or later

Contents of trouble	Check points and countermeasures	OS version		
		F940W	F940	F930
"CAN NOT USE THE FUNCTION WHILE PROTECTED." is displayed on the GOT-F900 screen.	This error is not displayed.	From first product	From first product	From first product
"PLC IS RUNNING." is displayed on the GOT-F900 screen.	This error is not displayed.	From first product	From first product	From first product

2) Software

	Contents of trouble	Check points and countermeasures
Screen creation software	Communication with the screen creation software and screen data cannot be transferred.	<p>A microcomputer, bar code reader or printer is connected.</p> <ul style="list-style-type: none"> <li>• Causes The RS-232C connector to which the personal computer is connected is set to be used for another piece of equipment.</li> <li>• Countermeasures In the GOT-F900, select by hand "SELECT MODE"- "OTHER MODE"- "DATA TRANSFER". Or set a bar code printer to invalid and a printer to "DON'T USE".</li> </ul> <p>Something is wrong with the cable between the GOT-F900 and the personal computer.</p> <ul style="list-style-type: none"> <li>• Causes The connected cable is not proper. Or cable connection is not correct.</li> <li>• Countermeasures Check the cable.</li> </ul>

## 14.11 BASIC Program Example

This program writes "31000" to D10 and "15600" to D11 respectively. "31000" is "7918H" and "15600" is "3CF0H" in hexadecimal. These two values are written to the GOT by the batch write command (01H).

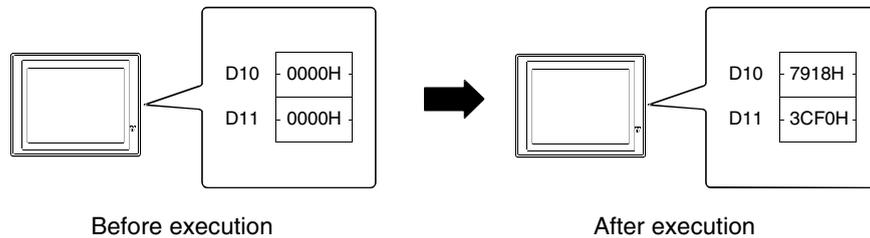

```

10'   Sample program
20'
500   T0=3000                               :'Counter waiting for receive (to be adjusted in accordance with
                                           speed of computer)

530   ERFLG=0
610   STX$=CHR$(2)
620   CR$=CHR$(13)
630   ACK$=CHR$(6)
640   NAK$=CHR$(&H15)
1000  *DATASEND                               :'Sends of statement
1010  CLOSE#1
1020  OPEN"COM1&F"AS#1
1030  SENDDATA$="100140479183CF0"           :'Send statement
1040  PRINT#1, STX$;SENDDATA$;CR$;
1100  *REC0                                   :'Receive of first character
1110  RVCNT=1
1120  GOSUB *JYUSHIN
1130  IF ERFLG=99 THEN GOTO *ERRORFIN1
1140  BUF$=RCV$
1150  HED$=LEFT$(BUF$,1)
1160  IF HED$=ACK$ THEN GOTO *FIN
1170  *ERRORFIN1
1180  PRINT"Error code is sent back."
1190  GOTO *FIN
1700  *ERRORFIN1
1710  PRINT"No response"
2000  *FIN
2010  CLOSE#1
2020  END
2100  *JYUSHIN                               :'Waiting for receive
2110  FORI=1 TO T0
2120  RCV$=""
2130  IF LOC(1)=>RVCNT THEN GOTO *BUFIN
2140  NEXT
2150  IF RCV$="" THEN ERFLG=99
2160  RETURN
2200  *BUFIN                                 :'Reads of receive data
2210  RCV$=INPUT$(RVCNT,#1)
2220  RETURN

```

# MEMO



## 15. Connection of SYSMAC C Series PLC (Manufactured by Omron)

This chapter explains the procedure to connect the GOT-F900 Series display unit to the SYSMAC C Series PLC.

### Connection Procedure

This section introduces the procedure to connect the GOT-F900 to the SYSMAC C Series PLC.

#### 1. Preparation

Item name	Description	Reference
System Condition	You can learn the connection availability as well as the version of the GOT-F900 OS and the screen creation software.	15.1
Classification of Host Link/Serial Communication Units	You can learn the classification of the CQM1, C200H and CS1 Series units.	15.1.1
System Configuration	You can select the configuration between the GOT and the SYSMAC C Series PLC and proper cables.	15.2

#### 2. Setting

Item name	Description	Reference
Communication specifications for host link	You can learn the communication specifications between the GOT and the SYSMAC C Series PLC.	15.3
Setting examples in CQM1/CQM1H/C200H Series	You can learn the contents of setting. You can learn the contents and positions to be set in each series.	15.4
Setting examples in CS1/CJ1 Series	You can learn the contents of setting. You can learn the contents and positions to be set in each series.	15.5
Setting examples in SYSMAC $\alpha$ (C200HE/HG/HX)/CPM 1A/2A/2C Series	You can learn the contents of setting. You can learn the contents and positions to be set in each series.	15.6
Caution on Use of SYSMAC C Series PLC	You can learn the restrictions in connecting the GOT to the SYSMAC C Series PLC.	15.7
Setting of Connected Equipment for GOT	Set the PLC type using the GOT or the screen creation software.	15.8

#### 3. Others

Item name	Description	Reference
Cable Diagram	Cable diagrams for SYSMAC C Series PLC/GOT connection	15.9
Troubleshooting	Description of errors and how to fix them	15.10

## 15.1 System Condition

When connecting the SYSMAC C Series PLC, check the COM port designation, the OS version of the GOT-F900, and applicable versions of the screen creation software.

Compatibility when connecting SYSMAC C Series PLC (CQM1/C200H)

GOT-F900 Series	COM port		Connection type		OS version of GOT-F900	Version of screen creation software		
	RS-422	RS-232C	1:1	Two or more GOT units		GT Designer2	GT Designer	DU/WIN
F920GOT-K(5V)	–	–	–	–	–	–	–	–
F920GOT-K(24V)	✓	✓	✓	–	1.20	SW1-C	–	–
F930GOT	✓	✓	✓	–	1.00	SW1-C	SW1-H	2.20
F930GOT-K	✓	✓	✓	–	4.60	SW1-C	SW5-26C	2.70
F940GOT	✓	✓	✓	–	1.00	SW1-C	SW1-A	2.00
F940WGOT	✓	✓	✓	–	1.00	SW1-C	SW5-F	2.50
F940 Handy GOT	✓	–	✓	–	1.00	SW1-C	SW1-D	2.10
F943 Handy GOT	–	✓	✓	–	1.00	SW1-C	SW1-D	2.10

- The screen creation software version corresponds to the model of the GOT-F900 Series. Refer to section 3.2.

Compatibility when connecting SYSMAC C Series PLC (CS1)

Type	F920GOT-K	F930GOT	F930GOT-K	F940GOT	F940WGOT	Handy GOT
Applicable version of GOT-F900	1.20 <sup>*1</sup>	4.00	4.60	6.00	1.00	6.00

\*1 Excluding the 5V type F920GOT-K.

- The screen creation software (GT Designer) version SW5-F (version 5.05F) or later which is applicable to the CS1 Series is required.

If screens are created using a version earlier than SW5-F (version 5.05F) or the DU/WIN, some devices extended in the CS1 Series cannot be set. (In such a case, set devices in the range for the C200H Series.) The DU/WIN will be applicable.

Compatibility when connecting SYSMAC C Series PLC (CQM1H)

Type	F920GOT-K	F930GOT	F930GOT-K	F940GOT	F940WGOT	Handy GOT
Applicable version of GOT-F900	1.20 <sup>*1</sup>	4.40	4.60	6.40	1.40	6.40

\*1 Excluding the 5V type F920GOT-K.

Compatibility when connecting SYSMAC α Series PLC (C200HE/HG/HX)

Compatibility when connecting SYSMAC C Series PLC (CPM1A/2A/2C,CJ1)

Type	F920GOT-K	F930GOT	F930GOT-K	F940GOT	F940WGOT	Handy GOT
Applicable version of GOT-F900	1.20 <sup>*1</sup>	4.62	4.62	6.62	1.62	6.62

\*1 Excluding the 5V type F920GOT-K.

### 15.1.1 Classification of Host Link/Serial Communication Units

In this section, the SYSMAC C Series units are classified as shown in the table below.

#### Classification

Product model name		Product type	RS-422	RS-232C
<b>SYSMAC COM1/C200H Series</b>				
CQM1-CPU21	–	CPU equipped with built-in RS-232C port (set as host link unit)	–	1
CQM1H-CPU61	–	CPU equipped with built-in RS-232C port (set as host link unit)	–	1
C200H-CPU01	C200H-LK201-V1	Host link unit	–	1
	C200H-LK202-V1	Host link unit	1	–
C200HS-CPU31	C200H-LK201-V1	Host link unit	–	1
	C200H-LK202-V1	Host link unit	1	–
<b>SYSMAC CS1 Series</b>				
CS1G-CPU45-V1	–	CPU equipped with built-in serial communication board	–	1
	CS1W-SCB41	Serial communication board	1	1
	CS1W-SCU21	Serial communication unit	–	2
<b>SYSMAC <math>\alpha</math> Series</b>				
C200HX-CPU44-Z	–	CPU equipped with built-in RS-232C port (set as host link unit)	–	1
	C200HW-COM06-V1	Serial communication board	1	1
<b>SYSMAC CPM 1A/2A/2C Series</b>				
CPM1A-10CDR-A	CQM1-CIF01	Peripheral port	–	1
CPM2A-30CDR-A	–	CPU equipped with built-in RS-232C port (set as host link unit)	–	1
CPM2C-10CDR-D	CPM2C-CIF01-V1	Peripheral port	–	1
	CPM2C-CN111	Peripheral port	–	1
<b>SYSMAC CJ1 Series</b>				
CJ1M-CPU12	–	CPU equipped with built-in RS-232C port (set as host link unit)	–	1
	CJ1W-SCU41	Serial communication unit	1	1
CJ1G-CPU44	–	CPU equipped with built-in RS-232C port (set as host link unit)	–	1
	CJ1W-SCU41	Serial communication unit	1	1

The difference between the CS1 serial communication board and the CS1 serial communication unit is as follows.

Board: Built in the CPU      Unit: Card type to be attached

11

Connection of  
MELSEC-Q  
Series PLC

12

Connection of  
FX Series  
Positioning

13

Connection of  
FREQROL  
Inverter

14

Connection of  
Microcom-  
puter

15

Connection of  
SYSMAC C  
Series PLC

16

Connection of  
FLEX-PC N  
Series PLC

17

Connection of  
Machine Con-  
troller

18

Connection of  
FP Series PLC

19

Connection of  
SLC500  
Series PLC

20

Connection of  
SIMATIC S7  
Series PLC

## 15.2 System Configuration

In the SYSMAC C Series PLC manufactured by Omron, using either RS-422 connection or RS-232C connection in host link units (including serial communication units/boards) is available. This section explains the cables and options required to connect the SYSMAC C Series PLC.

### 15.2.1 Applicable model

The GOT-F900 can be connected to the following equipment in accordance with its OS version. Operations are not assured when the GOT-F900 is connected to any other equipment. For details of the OS version of the GOT-F900 and applicable equipment, refer to "3.1 OS Version and Correspondence to Connected Equipment of GOT-F900".

CPU	OPTION	COMMUNICATION PORT
CQM1-CPU21 CQM1H-CPU61	–	Connection to built-in RS-232C port
C200H-CPU01 C200HS-CPU31	C200H-LK201-V1 C200H-LK202-V1	Connection to Host link unit
CS1G-CPU45-V1	–	Connection to built-in RS-232C port
	CS1W-SCB41	Connection to serial communication board
	CS1W-SCU21	Connection to serial communication unit
C200HX-CPU44-Z	–	Connection to built-in RS-232C port
	C200HW-COM06-V1	Connection to serial communication board
CPM1A-10CDR-A	CQM1-CIF01	Connection to peripheral port
CPM2A-30CDR-A	–	Connection to built-in RS-232C port
CPM2C-10CDR-D	CPM2C-CIF01-V1	Connection to peripheral port
	CPM2C-CN111	
CJ1M-CPU12	–	Connection to built-in RS-232C port
	CJ1W-SCU41	Connection to serial communication unit
CJ1G-CPU44	–	Connection to built-in RS-232C port
	CJ1W-SCU41	Connection to serial communication unit

### 15.2.2 Configuration for SYSMAC C Host Link Connection (RS-422)

The GOT-F900 and the host link unit can be connected on the 1:1 basis. As many GOT-F900 units as the number of host link units attached to the C200H/CS1 can be connected.

#### 1) F920GOT-K (24V type)/F930GOT/F930GOT-K/F940GOT/F940WGOT

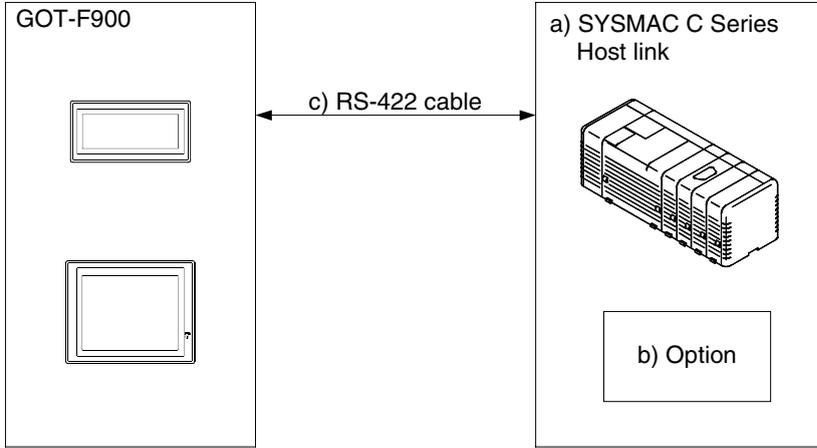

a) SYSMAC C Series	b) Option	c) RS-422 cable	Remarks
<b>SYSMAC COM1/C200H Series [Host link]</b>			
C200H-CPU01	C200H-LK202-V1	9-pin D-Sub	Prepared by user Host link unit
C200HS-CPU31	C200H-LK202-V1	9-pin D-Sub	Prepared by user Host link unit
<b>SYSMAC CS1 Series [Host link]</b>			
CS1G-CPU45-V1	CS1W-SCB41	9-pin D-Sub	Prepared by user Serial communication unit
<b>SYSMAC <math>\alpha</math> Series [Host link]</b>			
C200HX-CPU44-Z	C200HW-COM06-V1	9-pin D-Sub	Prepared by user Serial communication unit
<b>SYSMAC CJ1 Series [Host link]</b>			
CJ1M-CPU12	CJ1W-SCU41	9-pin D-Sub	Prepared by user Serial communication unit
CJ1G-CPU44	CJ1W-SCU41	9-pin D-Sub	Prepared by user Serial communication unit

- Applicable SYSMAC C Series products in the column a) are host link units equipped with built-in RS-422 interface.

11 Connection of MELSEC-Q Series PLC

12 Connection of FX Series Positioning

13 Connection of FREQROL Inverter

14 Connection of Micro-computer

15 Connection of SYSMAC C Series PLC

16 Connection of FLEX-PCN Series PLC

17 Connection of Machine Controller

18 Connection of FP Series PLC

19 Connection of SLC500 Series PLC

20 Connection of SIMATIC S7 Series PLC

2) F940 Handy GOT

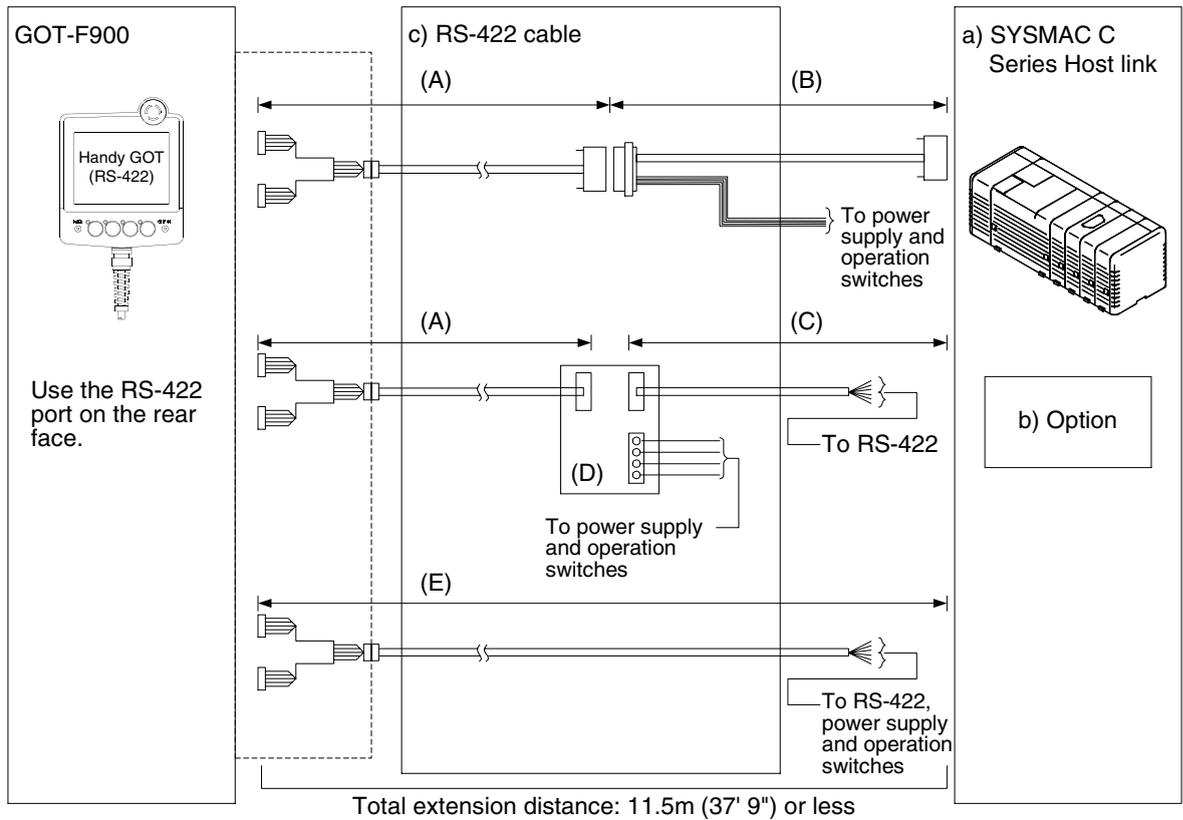

a) SYSMAC C Series	b) Option		c) RS-422 cable	Remarks
<b>SYSMAC COM1/C200H Series [Host link]</b>				
C200H-CPU01	C200H-LK202-V1	9-pin D-Sub	(A) FGT-HCAB-□□M	Host link unit
C200HS-CPU31	C200H-LK202-V1	9-pin D-Sub	(B) Prepared by user	Host link unit
<b>SYSMAC CS1 Series [Host link]</b>				
CS1G-CPU45-V1	CS1W-SCB41	9-pin D-Sub	(C) Prepared by user	Serial communication unit
<b>SYSMAC α Series [Host link]</b>				
C200HX-CPU44-Z	C200HW-COM06-V1	9-pin D-Sub	(D) F9GT-HCNB	Serial communication unit
<b>SYSMAC CJ1 Series [Host link]</b>				
CJ1M-CPU12	CJ1W-SCU41	9-pin D-Sub	(E) F9GT-HCAB1-□□M	Serial communication unit
CJ1G-CPU44	CJ1W-SCU41	9-pin D-Sub		Serial communication unit

- Applicable SYSMAC C Series products in the column a) are host link units equipped with built-in RS-422 interface.

### 15.2.3 Configuration for SYSMAC C Host Link Connection (RS-232C)

The GOT-F900 and the host link unit can be connected on the 1:1 basis. One GOT-F900 unit can be connected to the RS-232C built in the CQM1, CQM1H or CS1 CPU.

#### 1) In the case of F920GOT-K (24V type)/F930GOT/F930GOT-K/F940GOT/F940WGOT

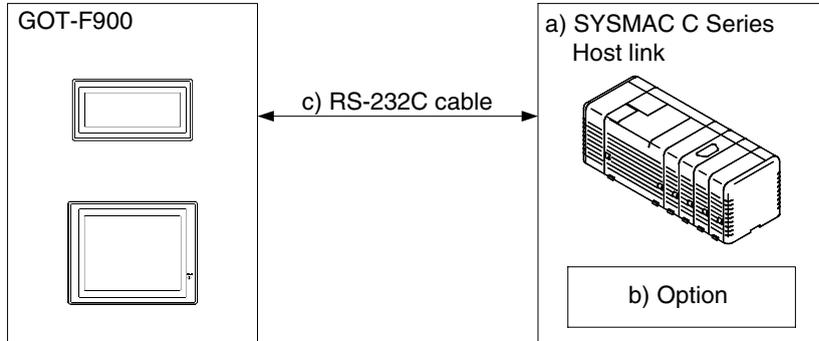

a) SYSMAC C Series	b) Option	c) RS-232C cable		Remarks
<b>SYSMAC COM1/C200H Series [Host link]</b>				
CQM-CPU21	–	9-pin D-Sub	Prepared by user	CPU unit (RS-232C built-in)
C200H-CPU01	C200H-LK201-V1	25-pin D-Sub	Prepared by user	Host link unit
CQM1H-CPU61	–	9-pin D-Sub	Prepared by user	CPU unit (RS-232C built-in)
C200HS-CPU31	C200H-LK201-V1	25-pin D-Sub	Prepared by user	Host link unit
<b>SYSMAC CS1 Series [Host link]</b>				
CS1G-CPU45-V1	–	9-pin D-Sub	Prepared by user	CPU unit (RS-232C built-in)
CS1G-CPU45-V1	CS1W-SCB41	9-pin D-Sub	Prepared by user	Serial communication board
CS1G-CPU45-V1	CS1W-SCU21	9-pin D-Sub	Prepared by user	Serial communication unit
<b>SYSMAC α Series [Host link]</b>				
C200HX-CPU44-Z	–	9-pin D-Sub	Prepared by user	CPU unit (RS-232C built-in)
C200HX-CPU44-Z	C200HW-COM06-V1	9-pin D-Sub	Prepared by user	Serial communication board
<b>SYSMAC CPM 1A/2A/2C Series [Host link]</b>				
CPM1A-10CDR-A	CQM1-CIF01	9-pin D-Sub	Prepared by user	CPU unit
CPM2C-10CDR-D	CPM2C-CIF01-V1	9-pin D-Sub	Prepared by user	CPU unit
CPM2C-10CDR-D	CPM2C-CN111	9-pin D-Sub	Prepared by user	CPU unit
CPM2A-30CDR-A	–	9-pin D-Sub	Prepared by user	CPU unit (RS-232C built-in)
<b>SYSMAC CJ1 Series [Host link]</b>				
CJ1M-CPU12	–	9-pin D-Sub	Prepared by user	CPU unit (RS-232C built-in)
CJ1M-CPU12	CJ1W-SCU41	9-pin D-Sub	Prepared by user	Serial communication unit
CJ1G-CPU44	–	9-pin D-Sub	Prepared by user	CPU unit (RS-232C built-in)
CJ1G-CPU44	CJ1W-SCU41	9-pin D-Sub	Prepared by user	Serial communication unit

- Applicable SYSMAC C Series products in the column a) are host link units equipped with built-in RS-232C interface.

2) F943 Handy GOT

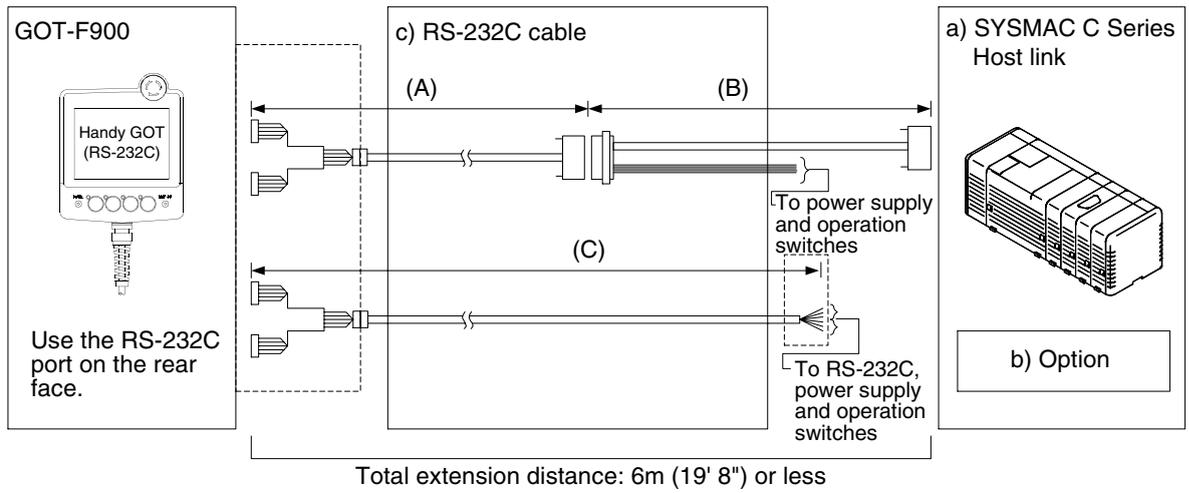

a) SYSMAC C Series	b) Option		c) RS-232C cable	Remarks
<b>SYSMAC COM1/C200H Series [Host link]</b>				
CQM-CPU21	-	9-pin D-Sub	(A) FGT-HCAB-3M	CPU unit (RS-232C built-in)
C200H-CPU01	C200H-LK201-V1	25-pin D-Sub	(B) Prepared by user	Host link unit
CQM1H-CPU61	-	9-pin D-Sub	(C) F9GT-HCAB1-3M	CPU unit (RS-232C built-in)
C200HS-CPU31	C200H-LK201-V1	25-pin D-Sub		Host link unit
<b>SYSMAC CS1 Series [Host link]</b>				
CS1G-CPU45-V1	-	9-pin D-Sub		CPU unit (RS-232C built-in)
CS1G-CPU45-V1	CS1W-SCB41	9-pin D-Sub		Serial communication board
CS1G-CPU45-V1	CS1W-SCU21	9-pin D-Sub		Serial communication unit
<b>SYSMAC α Series [Host link]</b>				
C200HX-CPU44-Z	-	9-pin D-Sub		CPU unit (RS-232C built-in)
C200HX-CPU44-Z	C200HW-COM06-V1	9-pin D-Sub		Serial communication board
<b>SYSMAC CPM 1A/2A/2C Series [Host link]</b>				
CPM1A-10CDR-A	CQM1-CIF01	9-pin D-Sub		CPU unit
CPM2C-10CDR-D	CPM2C-CIF01-V1	9-pin D-Sub		CPU unit
CPM2C-10CDR-D	CPM2C-CN111	9-pin D-Sub		CPU unit
CPM2A-30CDR-A	-	9-pin D-Sub		CPU unit (RS-232C built-in)
<b>SYSMAC CJ1 Series [Host link]</b>				
CJ1M-CPU12	-	9-pin D-Sub		CPU unit (RS-232C built-in)
CJ1M-CPU12	CJ1W-SCU41	9-pin D-Sub		Serial communication unit
CJ1G-CPU44	-	9-pin D-Sub		CPU unit (RS-232C built-in)
CJ1G-CPU44	CJ1W-SCU41	9-pin D-Sub		Serial communication unit

- Applicable SYSMAC C Series products in the column a) are host link units equipped with built-in RS-232C interface.
- Make sure that the total cable extension distance "(A) + (B)" or (C) is 6 m (19' 8") or less.



### 15.3 Communication Specifications for Host Link

With regard to the communication specifications in the SYSMAC C Series PLC, set the command level to the host link mode, and set the transmission specifications shown below.

#### Setting the transmission specifications

Set the transmission specifications in the serial communication unit as shown in the table below. For the switch setting method, refer to the manual of each host link unit.

Item	Set value	Remarks
Transmission speed	19200 bps	
Data format	Data bit	7bit
	Parity bit	Provided (even)
	Stop bit	2 bits
Command level	Host link mode	
Procedure	1 : N	

- The specifications such as the transmission speed are fixed on the GOT-F900 side, and cannot be changed.

#### Setting the unit number (station number) setting switches

The unit number is regarded as the station number in the GOT-F900.

The available range varies depending on the OS version as shown in the table below.

GOT-F900	OS version	Contents of setting
F920GOT-K(5V)	--	--
F920GOT-K(24V)	1.20 or later	Set the value (0 to 31) set in the GOT-F900.
F930GOT	3.00 or later	
F930GOT-K	4.60 or later	
F940GOT	5.00 or later	
F940WGOT	1.00 or later	
F940 Handy GOT	5.00 or later	
F943 Handy GOT	5.00 or later	
Version former than above		Set the value (0 to 15) set in the GOT-F900.

## 15.4 Setting Examples in CQM1/CQM1H/C200H Series

While referring to the setting examples in the CQM1/CQM1H/C200H Series host link unit, set the transmission specifications.

The examples below explain the setting in the CQM1/CQM1H (equipped with built-in RS-232C port), the C200H-LK201-V1 and the C200H-LK202-V1.

### 1) In the case of CQM1/CQM1H Series (CPU equipped with built-in RS-232C port)

In the CPU CQM1-CPU21/CQM1H-CPU61, execute the setting using the data memory (DM).

Setting item	Set value	Remarks
Setting of standard communication condition (RS-232C: DN6645)	0001H	Mode specification: Upper link Communication condition: In accordance with DM6646
Setting of communication condition (RS-232C: DN6646)	0304H	Transmission format: 7 data bits, 2 stop bits, even parity Transmission speed: 19,200 bps
Setting of transmission delay time (RS-232C: DM6647)	0000H (default status)	0 sec
Setting of unit number (RS-232C: DM6648)	00××H	××: 2-digit BCD (in accordance with the setting on the GOT side)

2) In the case of C200H Series (host link unit)

In the host link unit C200H-LK201-V1, execute the setting using each switch.

Switch position	Setting item	Switch setting		Remarks	
Front face	Unit number	SW1	–	BCD upper digit	(Correspond to the station number of the GOT-F900.)
		SW2	–	BCD lower digit	
	Transmission speed	SW3	6	19200bps	
	Communication condition	SW4	2	7-bit ASCII, 2 stop bits, even parity, command level 1, 2 or 3	
Rear face	Procedure	DIP. SW No.3	ON	1:N procedure	
	5V power supply	DIP. SW No.4	OFF	5V is not supplied.	
	CTS changeover	Selector SW	Upper side	External	

Setting Example

Switch setting on the front face

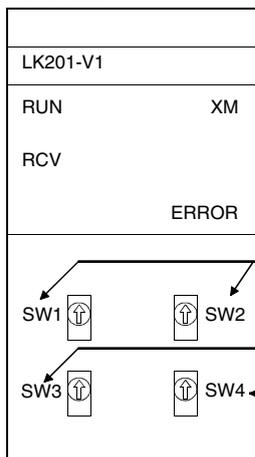

- 1) SW1 and SW2 (setting of unit number)  
Set "SW1: 0, SW2: 0" (to set the unit number 00).
- 2) SW3 (setting of transmission speed)  
Set "SW3:6" (to set 19200bps).
- 3) SW4 (setting of command level, parity and transmission code)  
Set "SW4:2" (to set even parity, 7-bit ASCII and 2 stop bits).
- 4) 5V supply SW

SW No.	ON	OFF
1	Not used (to be set to OFF)	
2		
3	1:N procedure	1:1 procedure
4	5V is supplied.	5V is not supplied.

Switch setting on the rear face

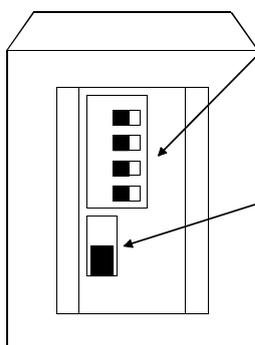

- 5) CTS selector SW  
Set the switch to the 0V side to always set the CTS to ON.  
Set the switch to the external side to receive from the outside.  
Usually, set this switch to the 0V side.

**3) In the case of C200H Series (host link unit)**

In the host link unit C200H-LK202-V1, execute the setting using each switch.

Switch position	Setting item	Switch setting		Remarks	
Front face	Unit number	SW1	–	BCD upper digit	(Correspond to the station number of the GOT-F900.)
		SW2	–	BCD lower digit	
	Transmission speed	SW3	6	19200bps	
	Communication condition	SW4	2	7-bit ASCII, 2 stop bits, even parity, command level 1, 2 or 3 are valid	
Rear face	Procedure	Right selector SW	Lower side	1:N procedure	
	Terminal resistor connection	Left selector SW	Upper side	Presence	

**Setting Example**

Switch setting on the front face

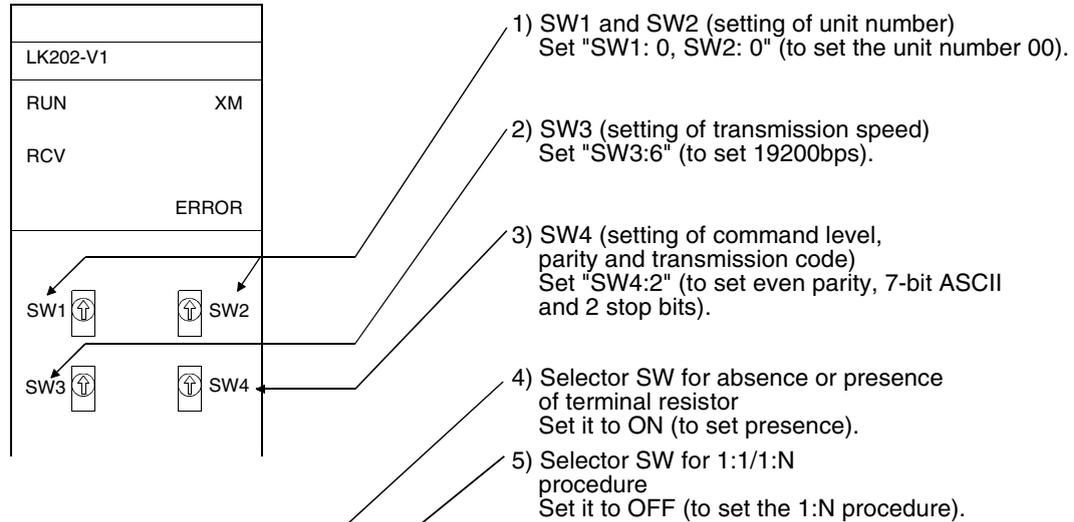

Switch setting on the rear face

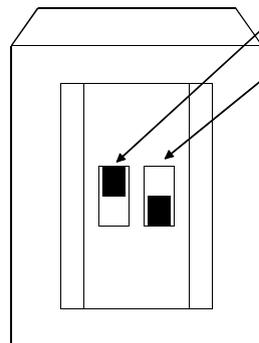

## 15.5 Setting Examples in CS1/CJ1 Series

When connecting the GOT-F900 to the CS1/CJ1 Series, the data shown below should be written to channels or data memory (DM) using a peripheral tool.

This paragraph explains the contents of data memory (DM) to be set in each unit.

### 1) In the case of CS1 Series (CPU equipped with built-in RS-232C port)

In the CPU CS1G-CPU45-V1, set the DIP switch shown below.

Setting item	Set value	Remarks
CS1G-CPU45-V1 DIP switch SW5	OFF	

In the CPU CS1G-CPU45-V1, write data to the channels shown below using a peripheral tool.

Setting item	Set value (hexadecimal)	Remarks
Communication (RS-232C: Channel 160)	8000H	Arbitrary setting: Provided Host link mode Data length: 7 bits Stop bit length: 2 bits Parity: Even
Transmission speed (RS-232C: Channel 161)	0007H	Baud rate: 19200 bps
Transmission delay time (RS-232C: Channel 162)	0000H	Transmission delay time: 0ms
Unit number (RS-232C: Channel 163)	0000 to 001FH	CTS control: Not provided Host link unit number: 00 to 1FH

### 2) In the case of CS1 Series (serial communication board)

When connecting the GOT-F900 to the port 1 or the port 2 in the CS1W-SCB41, set the DIP switch shown below.

Setting item	Set value	Remarks
CS1W-SCB41 DIP switch	4-wire type (without terminal resistor)	Refer to the description on the switches of the CS1W-SCB41.

The table below explains the data memory (DM) Nos. and set values which should be set using a peripheral tool.

Setting item	Setting item		Set value (hexadecimal)	Remarks
	Port 1	Port 2		
Communication	DM32000	DM32010	8000H	Arbitrary setting: Provided Host link mode Data length: 7 bits Stop bit length: 2 bits Parity: Even
Transmission speed	DM32001	DM32011	0007H	Baud rate: 19200bps
Transmission delay time	DM32002	DM32012	0000H	Transmission delay time: 0ms
Unit number	DM32003	DM32013	0000 to 001FH	CTS control: Not provided Host link unit number: 00 to 1FH

**3) In the case of CS1 Series (serial communication unit)**

When connecting the GOT-F900 to the port 1 and 2 of CS1W-SCU21, write data to the data memory (DM) shown in the table below using a peripheral tool to make the setting.

The data memory (DM) number to be written is a multiple of the unit number (0 to 16) as shown below.

Port	Calculation expression	Remarks
1	$DM3000 + 100 \times \text{Unit number}$	"Unit number" is a number of 0 to 16.
2	$DM3000 + 100 \times \text{Unit number} + 10$	

Example: When the unit number is set to "5"

Write the following set values.

Port 1:  $DM3000 + 100 \times 5 = DM3500$

Port 2:  $DM3000 + 100 \times 5 + 10 = DM3510$

The table below shows the data memory (DM) number and the set value when the unit number is set to "00"

Setting item	Setting item		Set value (hexadecimal)	Remarks
	Port 1	Port 2		
Communication	DM30000	DM30010	8000H	Arbitrary setting: Provided Host link mode Data length: 7 bits Stop bit length: 2 bits Parity: Even
Transmission speed	DM30001	DM30011	0007H	Baud rate: 19200 bps
Transmission delay time	DM30002	DM30012	0000H	Transmission delay time: 0ms
Unit number	DM30003	DM30013	0000 to 001FH	CTS control: Not provided Host link unit number: 00 to 1FH

**4) In the case of CJ1 Series (CPU equipped with built-in RS-232C port)**

In the CPU CJ1M-CPU12/CJ1G-CPU44, set the DIP switch as shown below.

Setting item	Set value	Remarks
CJ1G-CPU44 DIP switch SW5	OFF	

The table below explains the channel Nos. and set values which should be set using a peripheral tool.

Setting item	Set value (hexadecimal)	Remarks
Communication (RS-232C: Channel 160)	8000H	Arbitrary setting: Provided Host link mode Data length: 7 bits Stop bit length: 2 bits Parity: Even
Transmission speed (RS-232C: Channel 161)	0007H	Baud rate: 19200 bps
Transmission delay time (RS-232C: Channel 162)	0000H	Transmission delay time: 0ms
Unit number (RS-232C: Channel 163)	0000 to 001FH	CTS control: Not provided Host link unit number: 00 to 1FH

### 5) In the case of CJ1 Series (serial communication unit)

When connecting the GOT-F900 to the port 1 or the port 2 in the CS1W-SCU41, make the DIP switch settings as shown below.

Setting item	Set value	Remarks
CJ1W-SCU41 DIP switch	Terminal resistor: OFF	Refer to the description on the switches of the CJ1W-SCU41.
	Two and four-wire switching: four-wire	

When connecting the GOT-F900 to the port1 or the port2 in CS1W-SCU41, write data to the data memory (DM) shown in the table below using a peripheral tool to make the settings.

The data memory (DM) number to be written is a multiple of the unit number (0 to 16) as shown below.

Port	Calculation expression	Remarks
1	$DM3000 + 100 \times \text{Unit number}$	"Unit number" is a number of 0 to 16.
2	$DM3000 + 100 \times \text{Unit number} + 10$	

Example: When the unit number is set to "5"

Write the following set values.

Port 1:  $DM3000 + 100 \times 5 = DM3500$

Port 2:  $DM3000 + 100 \times 5 + 10 = DM3510$

The table below shows the data memory (DM) number and the set value when the unit number is set to "00"

Setting item	Setting item		Set value (hexadecimal)	Remarks
	Port 1	Port 2		
Communication	DM30000	DM30010	8000H	Arbitrary setting: Provided Host link mode Data length: 7 bits Stop bit length: 2 bits Parity: Even
Transmission speed	DM30001	DM30011	0007H	Baud rate: 19200 bps
Transmission delay time	DM30002	DM30012	0000H	Transmission delay time: 0ms
Unit number	DM30003	DM30013	0000 to 001FH	CTS control: Not provided Host link unit number: 00 to 1FH

## 15.6 Setting Examples in SYSMAC $\alpha$ (C200HE/HG/HX)/CPM 1A/2A/2C Series

When connecting the GOT-F900 to the SYSMAC  $\alpha$ (C200HE/HG/HX) or CPM 1A/2A/2C Series, the data shown below should be written to data memory (DM) using a peripheral tool.

This paragraph explains the contents of data memory (DM) to be set in each unit.

### 1) In the case of SYSMAC $\alpha$ Series (CPU equipped with built-in RS-232C port)

In the CPU C200HX-CPU44-Z, set the DIP switch shown below.

Setting item	Set value	Remarks
C200HX-CPU44-Z DIP switch SW5	OFF	

The table below explains the data memory (DM) Nos. and set values which should be set using a peripheral tool.

Setting item	Port	Set value (hexadecimal)	Remarks
Communication	DM6645	0001H	Communication condition: Set individually (in accordance with setting of DM6646) Host link mode CTS control: Not provided
Transmission speed	DM6646	0304H	Baud rate: 19200 bps Start bit length: 1 bit Data length: 7 bits Stop bit length: 2 bits Parity: Even
Transmission delay time	DM6647	0000H	Transmission delay time: 0ms
Unit number	DM6648	0000 to 0031	Host link unit number (BCD value)

### 2) In the case of SYSMAC $\alpha$ Series (serial communication board)

When connecting the GOT-F900 to the port 1 or the port 2 in the C200HW-COM06-V1, set the DIP switch shown below.

Setting item	Set value	Remarks
C200HW-COM06-V1 DIP switch SW1, 2	4-wire type (without terminal resistor)	Refer to the description on the switches of the C200HW-COM06-V1. DIP switch SW1: 4 DIP switch SW2: OFF

The table below explains the data memory (DM) Nos. and set values which should be set using a peripheral tool.

Setting item			Set value (hexadecimal)	Remarks
Setting item	Port B	Port A		
Communication	DM6550	DM6555	0001H	Communication condition: Set individually (in accordance with setting of next DM) Host link mode CTS control: Not provided
Transmission speed	DM6551	DM6556	0304H	Baud rate: 19200 bps Start bit length: 1 bit Data length: 7 bits Stop bit length: 2 bits Parity: Even
Transmission delay time	DM6552	DM6557	0000H	Transmission delay time: 0ms
Unit number	DM6553	DM6558	0000 to 0031	Host link unit number (BCD value)



**3) In the case of CPM1A Series (CPU equipped with built-in peripheral port)**

In the CPU CPM1A-10CDR-A, write data to the data memory (DM) shown in the table below using a peripheral tool.

The table below explains the data memory (DM) Nos. and set values which should be set using a peripheral tool.

Setting item	Port	Set value (hexadecimal)	Remarks
Communication	DM6650	0001H	Communication condition: Set individually (in accordance with setting of DM6651) Host link mode
Transmission speed	DM6651	0304H	Baud rate: 19200 bps Start bit length: 1 bit Data length: 7 bits Stop bit length: 2 bits Parity: Even
Transmission delay time	DM6652	0000H	Transmission delay time: 0ms
Unit number	DM6653	0000 to 0031	Host link unit number (BCD value)

**4) In the case of CPM2A Series (CPU equipped with built-in RS-232C port)**

In the CPU CPM2A-30CDR-A, write data to the data memory (DM) shown in the table below using a peripheral tool. In the CPU CPM2A-30CDR-A, set the DIP switch shown below.

Setting item	Set value	Remarks
CPM2A-30CDR-A Communication condition setting switch	OFF	

The table below explains the data memory (DM) Nos. and set values which should be set using a peripheral tool.

Setting item	Port	Set value (hexadecimal)	Remarks
Communication	DM6645	0001H	Communication condition: Set individually (in accordance with setting of DM6646) Host link mode CTS control: Not provided
Transmission speed	DM6646	0304H	Baud rate: 19200 bps Start bit length: 1 bit Data length: 7 bits Stop bit length: 2 bits Parity: Even
Transmission delay time	DM6647	0000H	Transmission delay time: 0ms
Unit number	DM6648	0000 to 0031	Host link unit number (BCD value)

**5) In the case of CPM2C Series (CPU equipped with built-in peripheral port)**

In the CPU CPM2C-10CDR-D, write data to the data memory (DM) shown in the table below using a peripheral tool. In the CPU CPM2C-10CDR-D, set the DIP switch shown below.

Setting item	Set value	Remarks
CPM2C-10CDR-D DIP switch SW1	OFF	

The table below explains the data memory (DM) Nos. and set values which should be set using a peripheral tool.

Setting item	Port	Set value (hexadecimal)	Remarks
Communication	DM6645	0001H	Communication condition: Set individually Host link mode CTS control: Not provided
Transmission speed	DM6646	0304H	Baud rate: 19200 bps Start bit length: 1 bit Data length: 7 bits Stop bit length: 2 bits Parity: Even
Transmission delay time	DM6647	0000H	Transmission delay time: 0ms
Unit number	DM6648	0000 to 0031	Host link unit number (BCD value)
No protocol communication	DM6649	0000H	Default (effective according to no protocol.)

## 15.7 Caution on Use of SYSMAC C Series PLC

When using the GOT-F900 connected to the SYSMAC C Series PLC, observe the following caution on use.

### 15.7.1 Modes in the SYSMAC C Series PLC

When the GOT-F900 is connected to the SYSMAC C Series PLC and the current value and the set value of each device of the SYSMAC C Series PLC are changed, the PLC should be set to the monitor mode. If the SYSMAC C Series PLC is started up in the running mode, the GOT-F900 sets automatically the PLC to the monitor mode.

Mode of PLC at startup	Operation of GOT
Running mode	The GOT-F900 changes over the PLC from the running mode to the monitor mode to enable data change.
Monitor mode	The PLC remains in the monitor mode, and data change is enabled.
Program mode	The PLC remains in the program mode, and data change is enabled.

### 15.7.2 Forced ON/OFF on the device monitor screen of the GOT-F900

The bit device ON/OFF function is provided on the user screen of the GOT-F900 and the forced ON/OFF function is provided on the device monitor screen in the HPP mode. These functions are also available when the SYSMAC C Series PLC is connected as the host unit.

Have in mind that these ON/OFF functions offer the following operation in the SYSMAC C Series PLC. The forced setting/resetting function in the SYSMAC C Series PLC holds the current ON/OFF status without regard to the sequence program. However, when using the forced ON/OFF function described here, the set/reset status of all the bit devices are released by turning ON/OFF the specified bit. ON/OFF operation in the sequence program is valid after operating the forced ON/OFF in the GOT-F900.

GOT-F900	SYSMAC C Series	Operation
Forced OFF (RST)	Data OFF specification	Turn OFF the contact. Can be changed by sequence program.
Forced ON (SET)	Data ON specification	Turn ON the contact. Can be changed by sequence program.
–	Forced reset specification	Turn OFF the contact. Cannot be changed by sequence program.
–	Forced set specification	Turn ON the contact. Cannot be changed by sequence program.
–	Forced set/reset release	Forced status of all the contacts released. Can be changed by the sequence program after the release.

In the following version of the GOT, when the forced ON/OFF is operated, only the bit forcedly turned ON/OFF is released.

GOT-F900	F920GOT-K (24V)	F930GOT	F930GOT-K	F940GOT	F940WGOT	Handy GOT
Compatible version	1.20	4.40	4.60	6.40	1.40	6.40

### 15.7.3 Restriction in functions

In host link connection, the following functions of the GOT-F900 are disabled or restricted.

- The switch function of the GOT-F900 (which sets a bit to ON or OFF) uses the host link FK command (which sets/resets multi points forcedly).
- Set values of the timer (T) and the counter (C) cannot be monitored or changed.

### 15.7.4 When using F920GOT-K

Only the F920GOT-K (24V type) can be connected. The following device range can be monitored.

Device name		Other than F920GOT-K	F920GOT-K (24V type)
Word device	Word data (D)	D0 to D4095 (4,096 points)	D0 to D1023 (1,024 points)

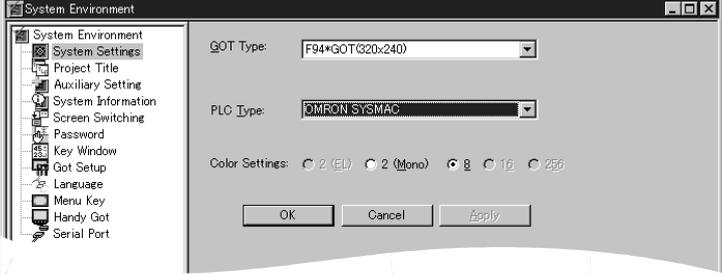
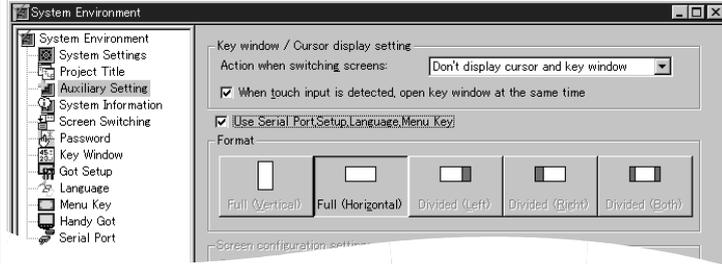

2) GT Designer2

	Operation	Display (screen name)										
[Creation]	<p>a) Open GT Designer2.</p> <p>b) Click the [NEW] button. The dialog box shown below is displayed. If it is not displayed, click "System Environment" in the tree displayed in the project work space, then click "System settings" in the tree.</p>  <p>c) Set the following. GOT type: F940WGOT (480 × 234) &lt;WIDE&gt; F94*GOT (320 × 240) F93*GOT (240 × 80) F920GOT (128 × 64) PLC type: OMRON SYSMAC Selection of "GOT type"</p> <table border="1" data-bbox="483 1039 1114 1285"> <thead> <tr> <th>GOT type</th> <th>Model name (name)</th> </tr> </thead> <tbody> <tr> <td>F940WGOT(480×234)&lt;WIDE&gt;</td> <td>F940WGOT</td> </tr> <tr> <td>F94*GOT(320×240)</td> <td>F940GOT Handy GOT</td> </tr> <tr> <td>F93*GOT(240×80)</td> <td>F930GOT F930GOT-K</td> </tr> <tr> <td>F920GOT(128×64)</td> <td>F920GOT-K</td> </tr> </tbody> </table> <p>Click [OK].</p> <p>d) Setting the port (RS-422 or RS-232C) of the GOT-F900 Click "Auxiliary Setting" in the tree of the system environment menu. Click the check box of "Use Serial Port, Setup, Language, Menu Key" to give a check mark (✓).</p> 	GOT type	Model name (name)	F940WGOT(480×234)<WIDE>	F940WGOT	F94*GOT(320×240)	F940GOT Handy GOT	F93*GOT(240×80)	F930GOT F930GOT-K	F920GOT(128×64)	F920GOT-K	<p>The "Select Project" dialog box appears.</p> <p>The "System Environment" dialog box appears.</p> <p>The "Setting" dialog box appears.</p>
GOT type	Model name (name)											
F940WGOT(480×234)<WIDE>	F940WGOT											
F94*GOT(320×240)	F940GOT Handy GOT											
F93*GOT(240×80)	F930GOT F930GOT-K											
F920GOT(128×64)	F920GOT-K											

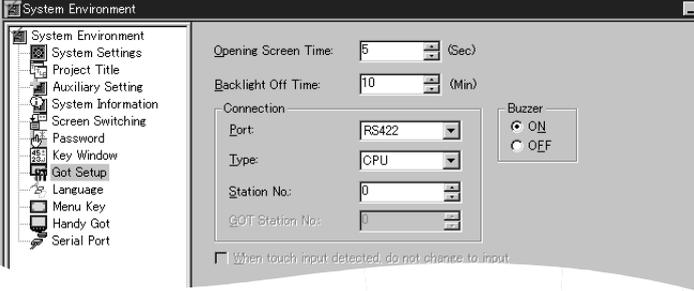
	Operation	Display (screen name)
	<p>Click "Got Setup" in the tree of the system environment menu.</p>  <p>e) Set the following.</p> <p>Port : RS-422 RS-232C</p> <p>Type : LINK</p> <p>Station No. : 00 to 31</p> <p>GOT Station No. : -</p> <p><u>In the case of F943 Handy GOT</u> Without regard to the port setting (RS-422 or RS-232C), the COM0 side of the RS-232C is fixed for PLC connection.</p>	
[Change method]	<p>Change the connection type of the already created data as follows.</p> <p>a) Open GT Designer2.</p> <p>b) Click the [Project]-[Open] button.</p> <p>c) Open (read) the screen data to be changed.</p> <p>d) On the menu, select "Common"- "System Environment".</p> <ul style="list-style-type: none"> <li>- For the contents of setting, refer to c) of [Creation] above.</li> <li>- For selection of the RS-422 or the RS-232C on the SYSMAC C Series PLCs, refer to e) of [Creation] above.</li> </ul>	<p>The "Select Project" dialog box appears.</p> <p>The "System Environment" dialog box appears.</p>

3) GT Designer

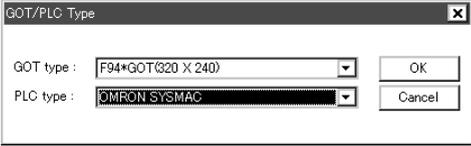
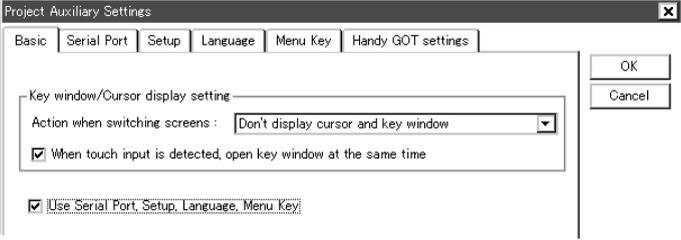
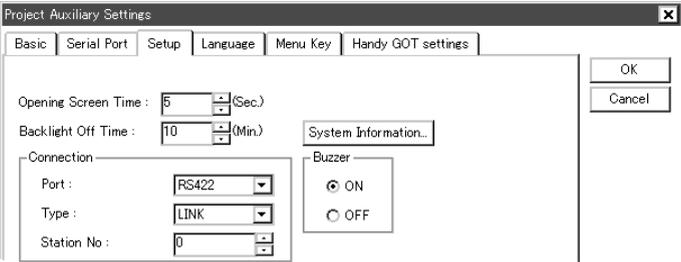
	Operation	Display (screen name)								
[Creation]	<p>a) Open GT Designer (Screen Designer).</p> <p>b) Click the [New] button.</p>  <p>c) Set the following.                      GOT type: F940WGOT (480 × 234) &lt;WIDE&gt;                      F94*GOT (320 × 240)                      F93*GOT (240 × 80)                      PLC type: OMRON SYSMAC                      Selection of "GOT type"</p> <table border="1" data-bbox="497 768 1106 981"> <thead> <tr> <th>GOT type</th> <th>Model name</th> </tr> </thead> <tbody> <tr> <td>F940WGOT(480×234)&lt;WIDE&gt;</td> <td>F940WGOT</td> </tr> <tr> <td>F94*GOT(320×240)</td> <td>F940GOT Handy GOT</td> </tr> <tr> <td>F93*GOT(240×80)</td> <td>F930GOT-K F930GOT</td> </tr> </tbody> </table> <p>Click [OK].</p> <p>d) Set link connection (RS-422/RS-232C) of the GOT-F900.                      This setting is enabled in the SW4D5C-GOTR-PACKE version A or later.                      Click the check box of "Use Serial Port, Setup, Language, Menu Key" to give a check mark (✓).</p>  <p>Click the "Setup" tab.</p> 	GOT type	Model name	F940WGOT(480×234)<WIDE>	F940WGOT	F94*GOT(320×240)	F940GOT Handy GOT	F93*GOT(240×80)	F930GOT-K F930GOT	<p>The "Select Project" dialog box appears.</p> <p>The "GOT/PLC Type" dialog box appears.</p>
GOT type	Model name									
F940WGOT(480×234)<WIDE>	F940WGOT									
F94*GOT(320×240)	F940GOT Handy GOT									
F93*GOT(240×80)	F930GOT-K F930GOT									

Operation		Display (screen name)
	<p>In the case of SW4D5C-GOTR-PACKE earlier than version A, perform the setting in the GOT-F900. (Set the connection in "CONNECTION" in the GOT-F900.) For the setting method, refer to "1) GOT-F900 Series" on the previous page.</p> <p>e) Set the following.</p> <p>Port : RS-422 RS-232C</p> <p>Type : LINK</p> <p>DST Station No. (Station No.) : 00 to 31</p> <p>GOT Station No. (-) : -</p>	
[Change method]	<p>Change the connection type of the already created data as follows.</p> <p>a) Open GT Designer.</p> <p>b) Click the [Open] button.</p> <p>c) Open (read) the screen data to be changed.</p> <p>d) On the menu, select "Common"-&gt;"GOT/PLC Type".</p> <ul style="list-style-type: none"> <li>- For the contents of setting, refer to c) of [Creation] above.</li> <li>- For selection of the RS-422 or the RS-232C on the SYSMAC C Series PLCs, refer to e) of [Creation] above.</li> </ul>	<p>The "Select Project" dialog box appears.</p> <p>The "GOT/PLC Type" dialog box appears.</p>

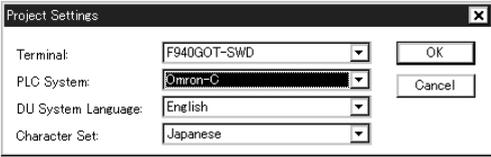
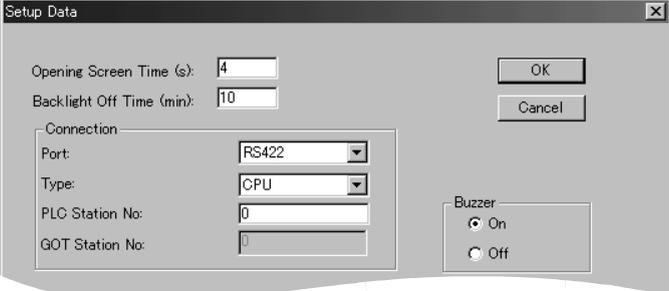

4) DU/WIN

	Operation	Display (screen name)										
[Creation]	<p>a) Open DU/WIN.</p> <p>b) On the menu, select "File"-"New".</p>  <p>c) Set the following.                      Terminal: F940WGOT-TWD (V) (H)                      F940GOT-LWD                      F940GOT-SWD                      F930GOT-BWD (V) (H)                      PLC System: Omron-C                      Select "Terminal" in accordance with the LC display color.</p> <table border="1" data-bbox="467 819 1136 1108"> <thead> <tr> <th>Terminal</th> <th>Model name</th> </tr> </thead> <tbody> <tr> <td>F940WGOT-TWD (V) (H)</td> <td>F940WGOT (color)</td> </tr> <tr> <td>F940GOT-LWD</td> <td>F940GOT (black and white) Handy GOT (black and white)</td> </tr> <tr> <td>F940GOT-SWD</td> <td>F940GOT (color) Handy GOT (color)</td> </tr> <tr> <td>F930GOT-BWD (V) (H)</td> <td>F930GOT-K (blue) F930GOT (blue)</td> </tr> </tbody> </table> <p>d) Set link connection (RS-422/RS-232C) of the GOT-F900.                      On the menu, select "View/Project"-"System Settings"-"Setup Data".</p>  <p>e) Set the following.                      Port: RS-422                      RS-232C                      Type: LINK                      DST Station No. (Station No.): 0 to 31                      GOT Station No. (-) : -</p>	Terminal	Model name	F940WGOT-TWD (V) (H)	F940WGOT (color)	F940GOT-LWD	F940GOT (black and white) Handy GOT (black and white)	F940GOT-SWD	F940GOT (color) Handy GOT (color)	F930GOT-BWD (V) (H)	F930GOT-K (blue) F930GOT (blue)	<p>The "Project settings" dialog box appears.</p> <p>The "Setup Data" dialog box appears.</p>
Terminal	Model name											
F940WGOT-TWD (V) (H)	F940WGOT (color)											
F940GOT-LWD	F940GOT (black and white) Handy GOT (black and white)											
F940GOT-SWD	F940GOT (color) Handy GOT (color)											
F930GOT-BWD (V) (H)	F930GOT-K (blue) F930GOT (blue)											
[Change method]	<p>Change the connection type of the already created data as follows.</p> <p>a) Open DU/WIN.</p> <p>b) On the menu, select "File"-"Open".</p> <p>c) Select and open (read) the file of the screen data to be changed.</p> <p>d) When changing "Terminal" (GOT-F900), select "View/Project"-"System Settings"-"Project settings" on the menu.                      - For the contents of setting, refer to c) of [Creation] above.                      - For selection of the RS-422 or the RS-232C on the SYSMAC C Series PLCs, refer to d) of [Creation] above.</p>	<p>The "Open" dialog box appears.</p>										

## 15.9 Cable Diagram

This section explains cable connection diagrams to connect the GOT-F900 and the SYSMAC C Series PLC manufactured by Omron.

### 15.9.1 Cautions on preparing cables

- 1) When preparing the cables, use the wire size of  $0.08\text{mm}^2$  or more (AWG28 or more) for communication,  $0.3\text{mm}^2$  or more (AWG22 or more) for the power supply, operation switch, and emergency stop switch.
- 2)  stands for a twisted pair cable. Prepare a twisted pair cable in combination of the pin numbers and signal lines described on the cable diagram.  
Do not use a twisted pair cable with the power supply wire and the communication wire.

15.9.2 Cable diagram

1) Cable for the GOT and the SYSMAC C Series PLC

 : Female type  : Male type The connector figure shows the engagement face.

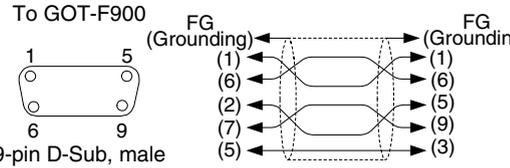
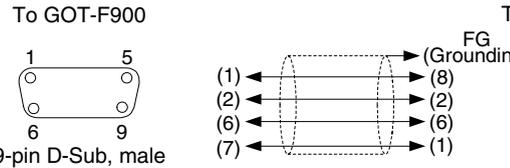
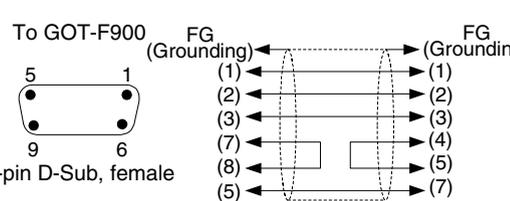
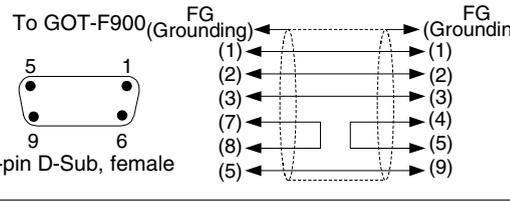
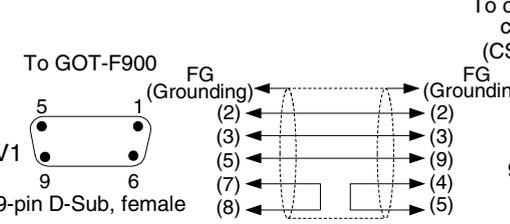
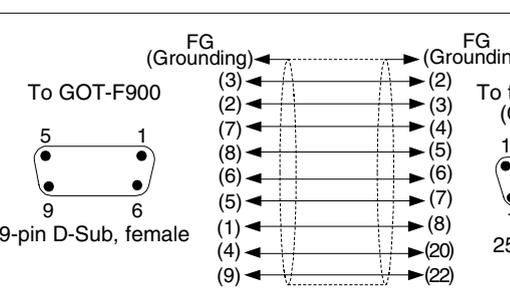
No.	Model name	Application	Connection diagram	Application
a)	<p><b>SYSMAC C Series</b></p> <p>RS-422 connection</p> <p>C200H-LK202-V1 Prepared by the user</p>	<p>To GOT-F900</p> <p>9-pin D-Sub, male</p>	 <p>FG (Grounding) (1) (6) (2) (7) (5)</p> <p>FG (Grounding) (1) (6) (5) (9) (3)</p>	<p>To host link unit side (C200H side)</p> <p>9-pin D-Sub, male</p>
b)	<p>CS1W-SCB41 CJ1W-SCU41 C200HW-COM06-V1 Prepared by the user</p> <p>RS-422 connection</p>	<p>To GOT-F900</p> <p>9-pin D-Sub, male</p>	 <p>FG (Grounding) (1) (2) (6) (7)</p> <p>FG (Grounding) (8) (2) (6) (1)</p>	<p>To communication unit (CS1, α side)</p> <p>9-pin D-Sub, male</p>
c)	<p>C200H-LK201-V1 Prepared by the user</p> <p>RS-232C connection</p>	<p>To GOT-F900</p> <p>9-pin D-Sub, female</p>	 <p>FG (Grounding) (1) (2) (3) (7) (8) (5)</p> <p>FG (Grounding) (1) (2) (3) (4) (5) (7)</p>	<p>To host link unit side (C200H side)</p> <p>25-pin D-Sub, male</p>
d)	<p>CQM1-CPU21 CQM1H-CPU61 Prepared by the user</p> <p>RS-232C connection</p>	<p>To GOT-F900</p> <p>9-pin D-Sub, female</p>	 <p>FG (Grounding) (1) (2) (3) (7) (8) (5)</p> <p>FG (Grounding) (1) (2) (3) (4) (5) (9)</p>	<p>To CQM1, CQM1H side (COM port)</p> <p>9-pin D-Sub, male</p>
e)	<p>CS1W-SCB41 CS1W-SCU21 CJ1W-SCU41 C200HW-COM06-V1 C200HX-CPU44-Z CS1G-CPU45-V1 CPM2A-30CDR-A CPM2C-10CDR-D+CPM2C-CIF01-V1 CPM2C-10CDR-D+CPM2C-CN111 CJ1M-CPU12 CJ1G-CPU44 Prepared by the user</p> <p>RS-232C connection</p>	<p>To GOT-F900</p> <p>9-pin D-Sub, female</p>	 <p>FG (Grounding) (1) (2) (3) (5) (7) (8)</p> <p>FG (Grounding) (2) (3) (9) (4) (5)</p>	<p>To communication board/communication unit (CS1, CJ1, CPM, α side)</p> <p>9-pin D-Sub, male</p>
f)	<p>CPM1A-10CDR-A+CQM1-CIF01 Prepared by the user</p> <p>RS-232C connection</p>	<p>To GOT-F900</p> <p>9-pin D-Sub, female</p>	 <p>FG (Grounding) (3) (2) (7) (8) (6) (5) (1) (4) (9)</p> <p>FG (Grounding) (2) (3) (4) (5) (7) (8) (20) (22)</p>	<p>To tool connection cable (CQM1-CIF01 side)</p> <p>25-pin D-Sub, female</p>

2) Cable for the Handy GOT and the SYSMAC C Series PLC

When using the Handy GOT RH model, refer to the cable diagrams below for the RS-422/RS-232C connector, but not the wiring for the power supply, the operation switches, and the emergency stop switch because it is different. For details, refer to Section 5.18.

 : Female type  : Male type The connector figure shows the engagement face.

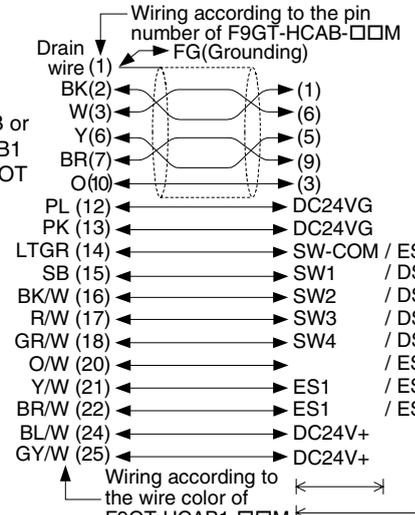
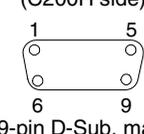
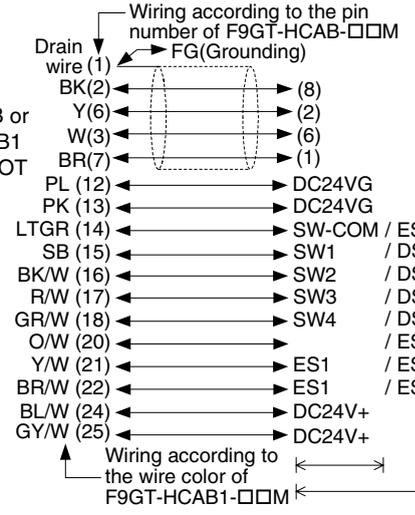
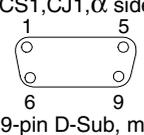
No.	Model name	Application	Connection diagram	Application	
a)	F9GT-HCAB-3M F9GT-HCAB-10M	<div style="border: 1px solid black; padding: 2px; display: inline-block;">RS-422 connection</div> <div style="border: 1px solid black; padding: 2px; display: inline-block;">RS-232C connection</div>	Dedicated connector on Handy GOT side	The connector on the leader side of the Handy GOT is dedicated, and cannot be prepared by the user.	To F9GT-HCAB3-150  25-pin D-Sub, male
b)	F9GT-HCAB1-3M F9GT-HCAB1-10M	<div style="border: 1px solid black; padding: 2px; display: inline-block;">RS-422 connection</div> <div style="border: 1px solid black; padding: 2px; display: inline-block;">RS-232C connection</div>	Dedicated connector on Handy GOT side	The connector on the leader side of the Handy GOT is dedicated, and cannot be prepared by the user.	Loose wires (no connector)
c)	SYSMAC C Series C200H-LK202-V1 Prepared by the user	<div style="border: 1px solid black; padding: 2px; display: inline-block;">RS-422 connection</div>	To cable F9GT-HCAB or F9GT-HCAB1 on Handy GOT side 	To host link unit side (C200H side)  9-pin D-Sub, male Wire the power supply, the operation switches and the emergency stop switch.	Old cable description New cable description
d)	CS1W-SCB41 CJ1W-SCU41 C200HW-COM06-V1 Prepared by the user	<div style="border: 1px solid black; padding: 2px; display: inline-block;">RS-422 connection</div>	To cable F9GT-HCAB or F9GT-HCAB1 on Handy GOT side 	To communication unit (CS1,CJ1,α side)  9-pin D-Sub, male Wire the power supply, the operation switches and the emergency stop switch.	Old cable description New cable description

: Female type : Male type The connector figure shows the engagement face.

No.	Model name	Application	Connection diagram	Application
e)	C200H-LK201-V1 Prepared by the user	RS-232C connection	<p>Wiring according to the pin number of F9GT-HCAB-□□M</p> <p>Drain wire (1) → FG (Grounding)</p> <p>To cable F9GT-HCAB or Handy GOT side: R(4), BK(2), Y(6), BR(7), O(10)</p> <p>To host link unit side (C200H side): 1, 13, 14, 25</p> <p>25-pin D-Sub, male</p> <p>Wiring according to the wire color of F9GT-HCAB1-□□M</p> <p>Old cable description → New cable description</p>	<p>To host link unit side (C200H side)</p> <p>Wire the power supply, the operation switches and the emergency stop switch.</p>
f)	CQM1-CPU21 CQM1H-CPU61 Prepared by the user	RS-232C connection	<p>Wiring according to the pin number of F9GT-HCAB-□□M</p> <p>Drain wire (1) → FG (Grounding)</p> <p>To cable F9GT-HCAB or Handy GOT side: R(4), BK(2), Y(6), BR(7), O(10)</p> <p>To CQM1, CQM1H side (COM port): 1, 5, 6, 9</p> <p>9-pin D-Sub, male</p> <p>Wiring according to the wire color of F9GT-HCAB1-□□M</p> <p>Old cable description → New cable description</p>	<p>To CQM1, CQM1H side (COM port)</p> <p>Wire the power supply, the operation switches and the emergency stop switch.</p>
g)	CS1W-SCB41 CS1W-SCU21 CJ1W-SCU41 C200HW-COM06-V1 C200HX-CPU44-Z CS1G-CPU45-V1 CPM2A-30CDR-A CPM2C-10CDR-D +CPM2C-CIF01-V1 CPM2C-10CDR-D +CPM2C-CN111 CJ1M-CPU12 CJ1G-CPU44 Prepared by the user	RS-232C connection	<p>Wiring according to the pin number of F9GT-HCAB-□□M</p> <p>Drain wire (1) → FG (Grounding)</p> <p>To cable F9GT-HCAB or Handy GOT side: R(4), BK(2), O(10), Y(6), BR(7)</p> <p>To communication board/communication unit (CS1, CJ1, CPM, α side): 1, 5, 6, 9</p> <p>9-pin D-Sub, male</p> <p>Wiring according to the wire color of F9GT-HCAB1-□□M</p> <p>Old cable description → New cable description</p>	<p>To communication board/communication unit (CS1, CJ1, CPM, α side)</p> <p>Wire the power supply, the operation switches and the emergency stop switch.</p>

 : Female type  : Male type The connector figure shows the engagement face.

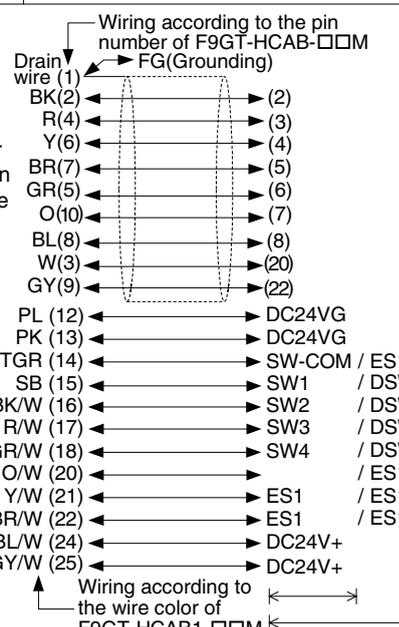
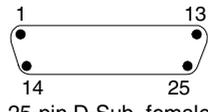
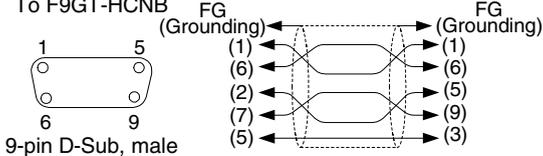
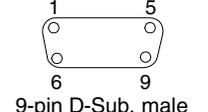
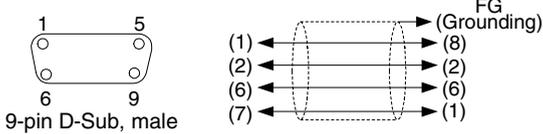
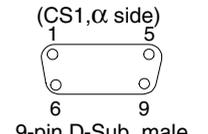
No.	Model name	Application	Connection diagram	Application
h)	CPM1A-10CDR-A+CQM1-CIF01 Prepared by the user	<p><b>RS-232C connection</b></p> <p>To cable F9GT-HCAB or F9GT-HCAB1 on Handy GOT side</p>	<p>Wiring according to the pin number of F9GT-HCAB-□□M</p>  <p>Drain wire (1) → FG (Grounding)</p> <p>BK(2) → (2) R(4) → (3) Y(6) → (4) BR(7) → (5) GR(5) → (6) O(10) → (7) BL(8) → (8) W(3) → (20) GY(9) → (22)</p> <p>PL(12) → DC24VG PK(13) → DC24VG LTGR(14) → SW-COM / ES1-2 SB(15) → SW1 / DSW2 BK/W(16) → SW2 / DSW2 R/W(17) → SW3 / DSW1 GR/W(18) → SW4 / DSW1 O/W(20) → / ES1-2 Y/W(21) → ES1 / ES1-1 BR/W(22) → ES1 / ES1-1 BL/W(24) → DC24V+ GY/W(25) → DC24V+</p> <p>Wiring according to the wire color of F9GT-HCAB1-□□M</p>	<p>To tool connection cable (CQM1-CIF01 side)</p>  <p>25-pin D-Sub, female</p> <p>Wire the power supply, the operation switches and the emergency stop switch.</p> <p>Old cable description → New cable description</p>
i)	SYSMAC C Series C200H-LK202-V1 Prepared by the user	<p><b>RS-422 connection</b></p> <p>To F9GT-HCNB</p>	 <p>FG (Grounding) → FG (Grounding)</p> <p>(1) → (1) (6) → (6) (2) → (5) (7) → (9) (5) → (3)</p>	<p>To host link unit side (C200H side)</p>  <p>9-pin D-Sub, male</p>
j)	CS1W-SCB41 CJ1W-SCU41 C200HW-COM06-V1 Prepared by the user	<p><b>RS-422 connection</b></p> <p>To F9GT-HCNB</p>	 <p>FG (Grounding) → FG (Grounding)</p> <p>(1) → (8) (2) → (2) (6) → (6) (7) → (1)</p>	<p>To communication board/communication unit (CS1, α side)</p>  <p>9-pin D-Sub, male</p>

## 15.10 Troubleshooting

For reference, this section summarizes frequently asked questions about connection of the GOT-F900 to the SYSMAC C Series PLC manufactured by Omron.

### 1) GOT-F900

Contents of trouble	Check points and countermeasures	OS version		
		F940W	F940	F930
"COMMUNICATION ERROR OCCURS" is displayed when a screen changeover or numeric data input is performed on the GOT-F900 screen.	<p>The power of the SYSMAC C Series PLC is turned off.</p> <ul style="list-style-type: none"> <li>• Cause Communication is disabled because the power of the SYSMAC C Series PLC is turned off.</li> <li>• Countermeasures Turn on the power.</li> </ul>	From first product	From first product	From first product
	<p>Something is wrong with the cable between the GOT-F900 and the SYSMAC C Series PLC.</p> <ul style="list-style-type: none"> <li>• Causes The wrong cable is used or the connection is bad.</li> <li>• Countermeasures Check the cable.</li> </ul>			
"DISPLAY SCREEN IS NOT AVAILABLE." is displayed on the GOT-F900 screen.	<p>Changeover to a nonexistent screen by a touch key or the SYSMAC C Series PLC was tried.</p> <ul style="list-style-type: none"> <li>• Cause The changeover destination screen has not been created yet.</li> <li>• Countermeasures Create the screen.</li> </ul>	–	Earlier than 6.00	Earlier than 4.00
"DISPLAY SCREEN IS NOT AVAILABLE. (NO. ####)" is displayed on the GOT-F900 screen.	<p>A nonexistent screen was tried to be displayed.</p> <ul style="list-style-type: none"> <li>• Cause The screen No. #### has not been created yet.</li> <li>• Countermeasures Create the screen.</li> </ul>	From first product	6.00 or later	4.00 or later
"DISPLAY SCREEN IS NOT AVAILABLE." is displayed on the GOT-F900 screen.	<p>A device that does not exist in the SYSMAC C Series PLC was referenced. (Example: While an C200H is connected, a device exists only in the CS1 is specified for numeric input.)</p> <ul style="list-style-type: none"> <li>• Cause On the changeover destination screen (excluding the head screen), a nonexistent device in the connected SYSMAC C Series PLC is specified.</li> <li>• Countermeasures Check the devices used on the head screen.</li> </ul>	–	Earlier than 6.00	Earlier than 4.00
	<p>There is an error on the screen to be displayed.</p> <ul style="list-style-type: none"> <li>• Cause One of the screen objects is placed outside the available screen area.</li> <li>• Countermeasures Check the placement of screen objects.</li> </ul>			

11

Connection of  
MELSEC-Q  
Series PLC

12

Connection of  
FX Series  
Positioning

13

Connection of  
FREQROL  
Inverter

14

Connection of  
Microcom-  
puter

15

Connection of  
SYSMAC C  
Series PLC

16

Connection of  
FLEX-PCN  
Series PLC

17

Connection of  
Machine Con-  
troller

18

Connection of  
FP Series PLC

19

Connection of  
SLC500  
Series PLC

20

Connection of  
SIMATIC S7  
Series PLC

Contents of trouble	Check points and countermeasures	OS version		
		F940W	F940	F930
"DISPLAY SCREEN IS NOT AVAILABLE. (NO. ####)" is displayed on the GOT-F900 screen.	<p>The display screen contains an error.</p> <ul style="list-style-type: none"> <li>Causes A device that does not exist in the connected PLC is referenced on the screen No. ####, or one of the screen objects is placed outside the available screen area.</li> <li>Countermeasures Check the devices used and placement of screen objects.</li> </ul>	From first product	6.00 or later	4.00 or later
"DATA IS NOT FOUND." is displayed on the GOT-F900 screen.	<p>There is not data because the unit is new or the memory clear has been executed.</p> <ul style="list-style-type: none"> <li>Cause There is no screen data.</li> <li>Countermeasures Write the screen data using the screen creation software.</li> </ul>	-	Earlier than 6.00	Earlier than 4.00
	<p>A device that does not exist in the SYSMAC C Series PLC was referenced. (Example: While an C200H is connected, a device exists only in the CS1 is specified for numeric input.)</p> <ul style="list-style-type: none"> <li>Cause On the head screen, a nonexistent device in the connected SYSMAC C Series PLC is specified. (The head screen is the screen No. 1 in the GT Designer, and the screen No. 0 in the DU/WIN.)</li> <li>Countermeasures Check the devices used on the head screen.</li> </ul>			
	<p>There is not data because the unit is new or the memory clear has been executed.</p> <ul style="list-style-type: none"> <li>Cause There is no screen data.</li> <li>Countermeasures Write the screen data using the screen creation software.</li> </ul>	From first product	6.00 or later	4.00 or later
"CAN NOT WRITE TO PLC MEMORY." is displayed on the GOT-F900 screen.	This error is not displayed.	Earlier than 1.10	Earlier than 6.10	Earlier than 4.10
"CAN NOT WRITE." is displayed on the GOT-F900 screen.	This error is not displayed.	1.10 or later	6.10 or later	4.10 or later
"CAN NOT USE THE FUNCTION WHILE PROTECTED." is displayed on the GOT-F900 screen.	This error is not displayed.	From first product	From first product	From first product
"PLC IS RUNNING." is displayed on the GOT-F900 screen.	This error is not displayed.	From first product	From first product	From first product



2) Software

	Contents of trouble	Check points and countermeasures
Screen creation software	Communication with the screen creation software and screen data cannot be transferred.	<p>A SYSMAC C Series PLC, bar code reader or printer is connected.</p> <ul style="list-style-type: none"> <li>• Causes The RS-232C connector to which the personal computer is connected is set to be used for another piece of equipment.</li> <li>• Countermeasures In the GOT-F900, select by hand "SELECT MODE"- "OTHER MODE"- "DATA TRANSFER". Or set a bar code reader to invalid and a printer to "DON'T USE".</li> </ul>
		<p>Something is wrong with the cable between the GOT-F900 and the personal computer.</p> <ul style="list-style-type: none"> <li>• Causes The connected cable is not proper. Or cable connection is not correct.</li> <li>• Countermeasures Check the cable.</li> </ul>

11 Connection of MELSEC-Q Series PLC

12 Connection of FX Series Positioning

13 Connection of FREQROL Inverter

14 Connection of Microcomputer

15 Connection of SYSMAC C Series PLC

16 Connection of FLEX-PC N Series PLC

17 Connection of Machine Controller

18 Connection of FP Series PLC

19 Connection of SLC500 Series PLC

20 Connection of SIMATIC S7 Series PLC

## MEMO

## 16. Connection of FLEX-PC N Series PLC (Manufactured by Fuji Electric)

This chapter explains the procedure to connect the GOT-F900 Series display unit to the FLEX-PC N Series PLC manufactured by Fuji Electric.

### Connection Procedure

This section introduces the procedure to connect the GOT-F900 to the FLEX-PC N Series PLC.

#### 1. Preparation

Item name	Description	Reference
System Condition	You can learn the connection availability as well as the version of the GOT-F900 OS and the screen creation software.	16.1
System Configuration	You can select the configuration between the GOT and the FLEX-PC N Series PLC and proper cables.	16.2

#### 2. Setting

Item name	Description	Reference		
Setting in Link Unit	You can learn the communication specifications and the contents of setting.		16.3	
	Communication Setting Specifications	The communication specifications between the link unit and the GOT unit		16.3.1
	Setting Examples	The contents and position of setting in each link unit		16.3.2
Caution on Use of FLEX-PC N Series PLC	You can learn the restrictions in connecting the GOT to the FLEX-PC N Series PLC.	16.4		
Setting of Connected Equipment for GOT	Set the PLC type using the GOT or the screen creation software.	16.5		

#### 3. Others

Item name	Description	Reference
Cable Diagram	Cable diagrams for FLEX-PC N Series PLC/GOT connection	16.6
Troubleshooting	Description of errors and how to fix them	16.7

### 16.1 System Condition

When connecting the FLEX-PC N Series PLC, check the COM port designation, the OS version of the GOT-F900, and applicable versions of the screen creation software.

Compatibility when connecting FLEX-PC N Series PLC

GOT-F900 Series	COM port		Connection type		OS version of GOT-F900	Version of screen creation software		
	RS-422	RS-232C	1:1	Two or more GOT units		GT Designer2	GT Designer	DU/WIN
F920GOT-K	-	-	-	-	-	-	-	-
F930GOT	✓	✓	✓	-	1.00	SW1-C	Not applicable	2.20
F930GOT-K	✓	✓	✓	-	4.60	SW1-C	Not applicable	2.70
F940GOT	✓	✓	✓	-	1.00	SW1-C	Not applicable	2.00
F940WGOT	✓	✓	✓	-	1.00	SW1-C	Not applicable	2.50
F940 Handy GOT	✓	-	✓	-	1.00	SW1-C	Not applicable	2.10
F943 Handy GOT	-	✓	✓	-	1.00	SW1-C	Not applicable	2.10

- The screen creation software version corresponds to the model of the GOT-F900 Series. Refer to section 3.2.

## 16.2 System Configuration

The FLEX-PC N Series PLC can be connected to the GOT via RS-422 or RS-232C using a link unit. This section explains the cables and options required to connect the FLEX-PC N Series PLC.

### 16.2.1 Applicable model

The GOT-F900 can be connected to the following equipment in accordance with its OS version. Operations are not assured when the GOT-F900 is connected to any other equipment. For details of the OS version of the GOT-F900 and applicable equipment, refer to "3.1 OS Version and Correspondence to Connected Equipment of GOT-F900".

CPU	OPTION	COMMUNICATION PORT
NJ-CPU-B16	–	Connection to built-in RS-232C port
NB series	NB-RS1-AC	Connection to link unit
NJ series	NJ-RS4 NJ-RS2	
NS series	NJ-RS1	

### 16.2.2 Configuration for Link Unit Connection (RS-422)

The GOT-F900 and the link unit can be connected on the 1:1 basis.

#### 1) F930GOT/F930GOT-K/F940GOT/F940WGOT

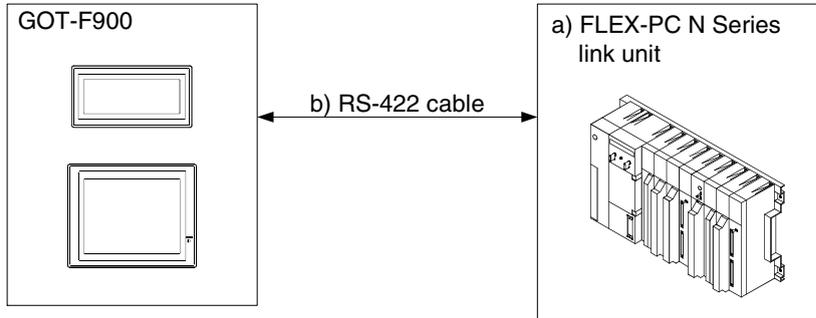

a) FLEX-PC N Series		b) RS-422 cable	Remarks
NB-RS1-AC NJ-RS4 NS-RS1	Terminal block	Prepared by the user	

- Applicable FLEX-PC N Series products in the column a) are link units equipped with built-in RS-422 interface.

#### 2) F940 Handy GOT

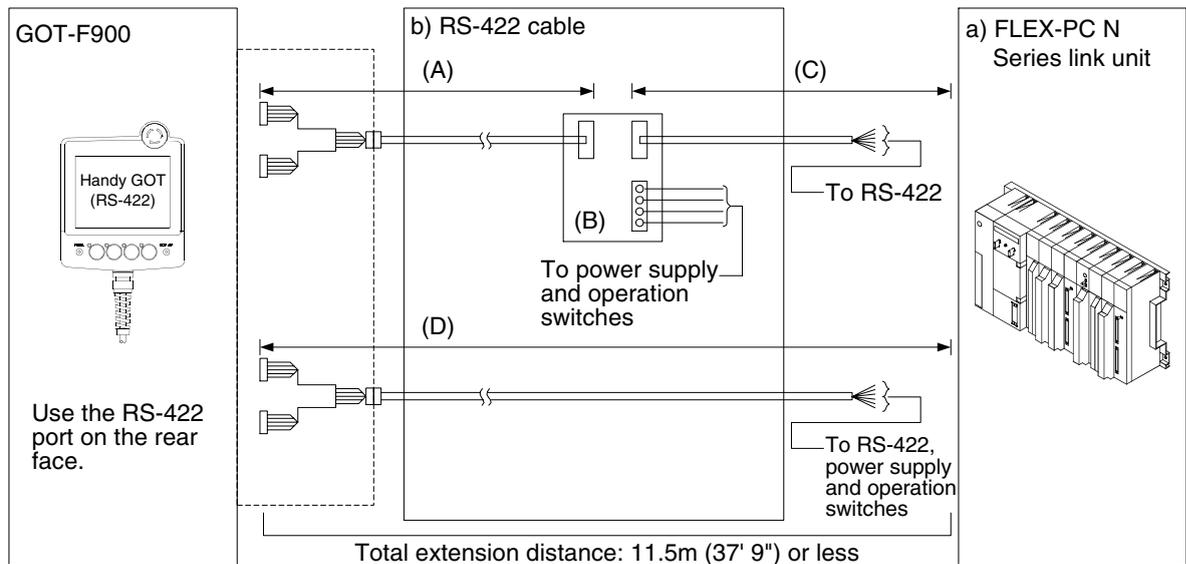

a) FLEX-PC N Series		b) RS-422 cable	Remarks
NB-RS1-AC NJ-RS4 NS-RS1	Terminal block	(A) F9GT-HCAB-□□M (B) F9GT-HCNCB (C) Prepared by the user. (D) F9GT-HCAB1-□□M	

- Applicable FLEX-PC N Series products in the column a) are link units equipped with built-in RS-422 interface.

### 16.2.3 Configuration for Link Unit Connection (RS-232C)

The GOT-F900 and the link unit can be connected on the 1:1 basis.

#### 1) F930GOT/F930GOT-K/F940GOT/F940WGOT

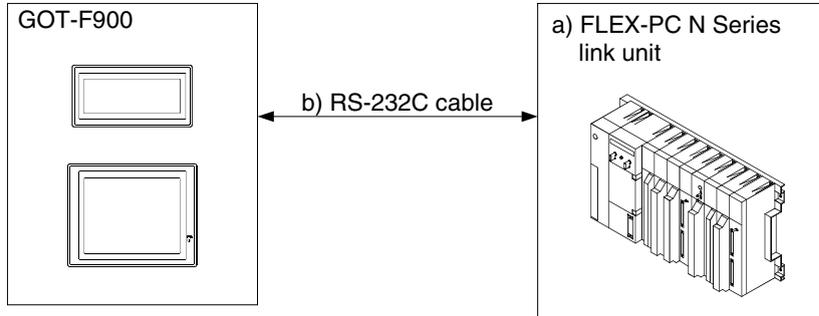

a) FLEX-PC N Series		b) RS-232C cable	Remarks
NB-RS1-AC	25-pin D-Sub	Prepared by the user	
NJ-RS2			
NS-RS1			
NJ-CPU-B16	15-pin D-Sub	Prepared by the user	

- Applicable FLEX-PC N Series products in the column a) are link units equipped with built-in RS-232C interface.

#### 2) F943 Handy GOT

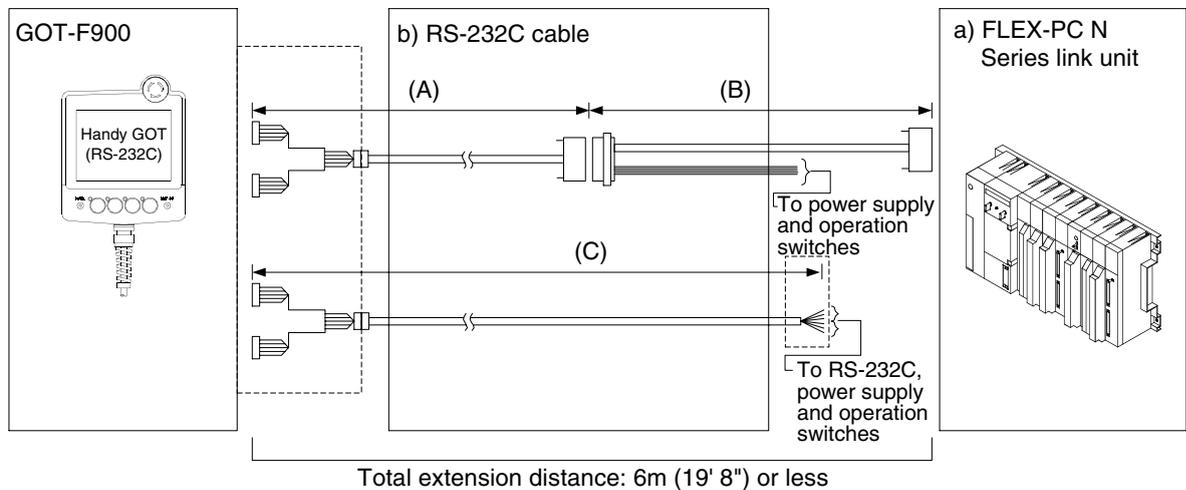

a) FLEX-PC N Series		b) RS-232C cable	Remarks
NB-RS1-AC	25-pin D-Sub	(A) F9GT-HCAB-□□M (B) Prepared by the user (C) F9GT-HCAB1-□□M	
NJ-RS2			
NS-RS1			
NJ-CPU-B16	15-pin D-Sub		

- Applicable FLEX-PC N Series products in the column a) are link units equipped with built-in RS-232C interface.  
 - Make sure that the total cable extension distance "(A) + (B)" or (C) is 6m (19' 8") or less.

## 16.3 Setting in Link Unit

When connecting the link unit, the switches in the link unit should be set as described below.

### 16.3.1 Communication Setting Specifications

This section explains the setting in the link unit.

#### 1) Setting the mode setting switch (link connection)

Set the mode so that the COM port of the link unit connected to the GOT-F900 is the asynchronous system and no protocol. (In the NJ-CPU-B16, the setting below is not required.)

COM port	Set value	Remarks
RS-422	3	Command setting type: asynchronous system, no protocol
RS-232C	1	Command setting type: asynchronous system, no protocol

#### 2) Setting the transmission specifications

Set the transmission specifications in the link unit as shown in the table below. For the switch setting method, refer to the manual of the link unit.

Item	Link unit connection		CPU direct connection
	RS-422	RS-232C	RS-232C
Transmission speed	19200 bps		
Data format	Data bit	7 bits (JIS)	8 bits (HEX)
	Parity bit	Even	Odd
	Stop bit	1 bit	

- The specifications such as the transmission speed are fixed on the GOT-F900 side, and cannot be changed.

#### 3) Setting the station number setting switches (link connection)

(In the NJ-CPU-B16, the station number cannot be set.)

The setting range varies depending on the OS version as shown in the table below.

GOT-F900	OS version	Setting
F920GOT-K	-	-
F930GOT	3.00 or later	Set the value set in the GOT-F900 (0 to 31).
F930GOT-K	4.60 or later	
F940GOT	5.00 or later	
F940WGOT	1.00 or later	
F940 Handy GOT	5.00 or later	
F943 Handy GOT	5.00 or later	
Any version earlier than above		Set the value set in the GOT-F900 (0 to 15).

11

Connection of MELSEC-Q Series PLC

12

Connection of FX Series Positioning

13

Connection of FREQROL Inverter

14

Connection of Microcomputer

15

Connection of SYSMAC C Series PLC

16

Connection of FLEX-PC N Series PLC

17

Connection of Machine Controller

18

Connection of FP Series PLC

19

Connection of SLC500 Series PLC

20

Connection of SIMATIC S7 Series PLC

### 16.3.2 Setting Examples

While referring to the setting examples in the link units, set the transmission specifications. The examples below explain the setting in the NJ-CPU-B16 (link unit), the NJ-RS4 and the NJ-RS2.

#### 1) NJ-CPU-B16

In the NJ-CPU-B16, use the parameter (50H) for setting.

Parameter	Data value	Contents of setting
50H	0057H	Baud rate: 19200 bps Stop bit: 1 bit Character length: 8 bits Parity: Odd

#### 2) NJ-RS4

In the NJ-RS4, use each switch for setting.

Switch position	Setting item	Description		Remarks
Front face	Mode	MODE SW	3	Command setting type: asynchronous system, no protocol
	Station number	Station number setting SW × 10	–	Upper digit
		Station number setting SW × 1	–	Lower digit
Rear face	Terminal resistor	Selector SW 1	ON	Receive line provided
		Selector SW 2	ON	Transmission line provided
	Communication condition	DIP.SW	1:OFF 2~8:ON	Set the condition using switches: 19200 bps, 7 bits, 1 stop bit and even parity

#### 3) NJ-RS2

In the NJ-RS2, use each switch for setting.

Switch position	Setting item	Description		Remarks
Rear face	Mode	MODE SW	1	Command setting type: asynchronous system, no protocol
	Communication condition	DIP.SW	1:OFF 2 to 8:ON	Set the condition using switches: 19200 bps, 7 bits, 1 stop bit and even parity

## 16.4 Caution on Use of FLEX-PC N Series PLC

When using the GOT-F900 connected to the FLEX-PC N Series PLC, observe the following caution on use.

### 16.4.1 Devices which can be monitored

When the GOT-F900 is connected to the FLEX-PC N Series link unit, set values of the timer (T) and the counter (C) cannot be monitored.



## 16.5 Setting of Connected Equipment for GOT

The setting for connection to the FLEX-PC N Series PLC can be executed using the GOT-F900 and the screen creation software (GT Designer2 or DU/WIN).

### Setting the Connection Type

Set the connection type in accordance with the connected equipment as shown in the table below. Have in mind that the NJ-CPU-B16 (link unit) requires CPU direct connection.

Connected equipment [classification in manual]	GOT-F900	DU/WIN	Remarks
	CONNECTION	Type	
[Link unit] NJ-CPU-B16(RS-232C)	CPU direct connection (RS-232C)		Executes communication as programming port
[Link unit] NB-RS1-AC(RS-422/RS-232C) NJ-RS4(RS-422) NJ-RS2(RS-232C) NS-RS1(RS-422/RS-232C)	Link connection (RS-422) or link connection (RS-232C)		Executes communication as link unit

#### 1) GOT-F900 Series

When the main menu screen change operation is disabled.

Operation	Display (screen name)
a) While pressing and holding the upper left corner of the screen, turn on the power. Keep holding the upper left corner for about 25 seconds more. Then, press "END" at the upper right corner. b) Press "PLC TYPE". c) Set the following. PLC TYPE: FUJI N SERIES CONNECTION: CPU PORT (RS-232C) LINK PORT (RS-422) LINK PORT (RS-232C) DST STATION # (STATION #) : 00 to 31 GOT STATION # (-) : -	The "LANGUAGE" screen appears.  The "SET-UP MODE" screen appears. The "PLC TYPE" screen appears.

When the main menu screen change operation is enabled.

Operation	Display (screen name)
a) Press the upper left corner of the screen. (The position to be pressed can be changed in the GOT and the screen creation software.) b) Press "OTHER MODE" on the menu. c) Press "SET-UP MODE" on the menu. d) Press "PLC TYPE". e) Set the following. PLC TYPE: FUJI N SERIES CONNECTION: CPU PORT (RS-232C) LINK PORT (RS-422) LINK PORT (RS-232C) DST STATION # (STATION #) : 00 to 31 GOT STATION # (-) : -	The "SELECT MODE" screen appears.  The "OTHER MODE" screen appears. The "SET-UP MODE" screen appears. The "PLC TYPE" screen appears.

- When the screen data is transferred to the GOT-F900, the old data including the PLC type, connection type, and station number are overwritten.

11 Connection of MELSEC-Q Series PLC  
12 Connection of FX Series Positioning  
13 Connection of FREQROL Inverter  
14 Connection of Microcomputer  
15 Connection of SYSMAC C Series PLC  
16 Connection of FLEX-PC N Series PLC  
17 Connection of Machine Controller  
18 Connection of FP Series PLC  
19 Connection of SLC500 Series PLC  
20 Connection of SIMATIC S7 Series PLC

2) GT Designer2

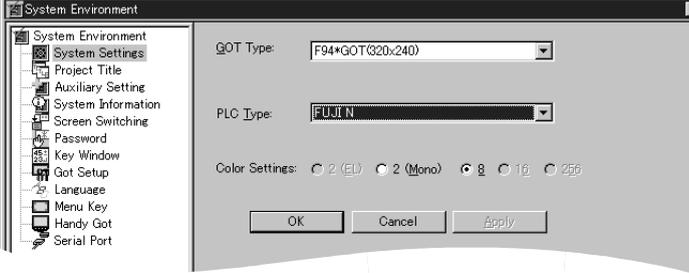
	Operation	Display (screen name)								
[Creation]	<p>a) Open GT Designer2.</p> <p>b) Click the [NEW] button. The dialog box shown below is displayed. If it is not displayed, click "System Environment" in the tree displayed in the project work space, then click "System settings" in the tree.</p>  <p>c) Set the following. GOT type: F940WGOT (480 × 234) F94*GOT (320 × 240) F93*GOT (240 × 80) PLC type: Fuji-N Selection of "GOT type"</p> <table border="1" data-bbox="483 1021 1114 1240"> <thead> <tr> <th>GOT type</th> <th>Model name (name)</th> </tr> </thead> <tbody> <tr> <td>F940WGOT(480×234)&lt;WIDE&gt;</td> <td>F940WGOT</td> </tr> <tr> <td>F94*GOT(320×240)</td> <td>F940GOT Handy GOT</td> </tr> <tr> <td>F930GOT(240×80)</td> <td>F930GOT F930GOT-K</td> </tr> </tbody> </table> <p>Click [OK].</p>	GOT type	Model name (name)	F940WGOT(480×234)<WIDE>	F940WGOT	F94*GOT(320×240)	F940GOT Handy GOT	F930GOT(240×80)	F930GOT F930GOT-K	<p>The "Select Project" dialog box appears.</p> <p>The "System Environment" dialog box appears.</p>
GOT type	Model name (name)									
F940WGOT(480×234)<WIDE>	F940WGOT									
F94*GOT(320×240)	F940GOT Handy GOT									
F930GOT(240×80)	F930GOT F930GOT-K									

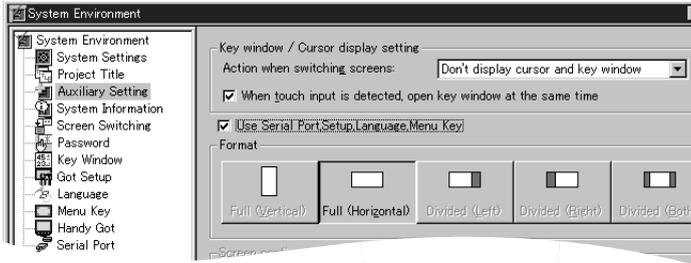
	Operation	Display (screen name)												
	<p>d) Set CPU direct connection (RS-232C) or link connection (RS-422/RS-232C) of the GOT-F900.                      Click "Auxiliary Setting" in the tree of the system environment menu.                      Click the check box of "Use Serial Port, Setup, Language, Menu Key" to give a check mark (✓).</p>  <p>Click "Got Setup" in the tree of the system environment menu.</p>  <p>e) Set the following.</p> <p>Port : RS-422                      RS-232C</p> <p>Type : CPU                      LINK</p> <p>Station No. : 00 to 31                      GOT Station No. : -</p> <p><u>In the case of F943 Handy GOT</u>                      Without regard to the port setting (RS-422 or RS-232C), the COM0 side of the RS-232C is fixed for PLC connection.                      Combinations of "Port" and "Type" are as follows.</p> <table border="1" data-bbox="470 1411 1133 1624"> <thead> <tr> <th>Connection destination</th> <th>Port</th> <th>Type</th> </tr> </thead> <tbody> <tr> <td>NB-RS1-AC(RS-422/RS-232C)</td> <td rowspan="3">RS-422/ RS-232C</td> <td rowspan="3">LINK</td> </tr> <tr> <td>NJ-RS4(RS-422)</td> </tr> <tr> <td>NJ-RS2(RS-232C)</td> </tr> <tr> <td>NS-RS1(RS-422/RS-232C)</td> <td rowspan="2">RS-232C</td> <td rowspan="2">CPU</td> </tr> <tr> <td>NJ-CPU-B16(RS-232C)</td> </tr> </tbody> </table>	Connection destination	Port	Type	NB-RS1-AC(RS-422/RS-232C)	RS-422/ RS-232C	LINK	NJ-RS4(RS-422)	NJ-RS2(RS-232C)	NS-RS1(RS-422/RS-232C)	RS-232C	CPU	NJ-CPU-B16(RS-232C)	<p>The "Auxiliary Settings" dialog box appears.</p>
Connection destination	Port	Type												
NB-RS1-AC(RS-422/RS-232C)	RS-422/ RS-232C	LINK												
NJ-RS4(RS-422)														
NJ-RS2(RS-232C)														
NS-RS1(RS-422/RS-232C)	RS-232C	CPU												
NJ-CPU-B16(RS-232C)														
<p>[Change method]</p>	<p>Change the connection type of the already created data as follows.</p> <p>a) Open GT Designer2.                      b) Click the [Project]-[Open] button.                      c) Open (read) the screen data to be changed.                      d) On the menu, select "Common"- "System Environment".                      - For the contents of setting, refer to c) of [Creation] above.                      - For selection of the RS-422 or the RS-232C on the FLEX-PC-N Series PLCs, refer to e) of [Creation] above.</p>	<p>The "Select Project" dialog box appears.</p> <p>The "System Environment" dialog box appears.</p>												

3) GT Designer

GT Designer cannot create screens for the FLEX-PC N Series PLC.

4) DU/WIN

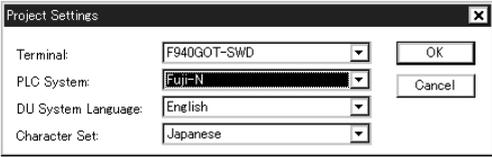
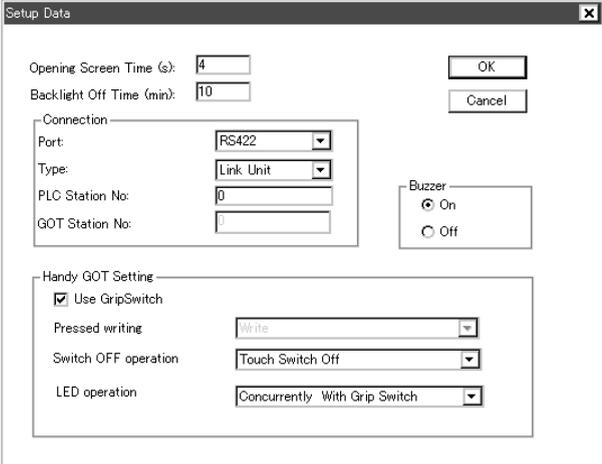
	Operation	Display (screen name)										
[Creation]	<p>a) Open DU/WIN.</p> <p>b) On the menu, select "File"-"New".</p>  <p>c) Set the following.                      Terminal: F940WGOT-TWD (V)(H)                      F940GOT-LWD                      F940GOT-SWD                      F930GOT-BWD (V)(H)                      PLC System: Fuji-N</p> <p>Select "Terminal" in accordance with the LC display color.</p> <table border="1" data-bbox="464 819 1134 1111"> <thead> <tr> <th>Terminal</th> <th>Model name</th> </tr> </thead> <tbody> <tr> <td>F940WGOT-TWD (V)(H)</td> <td>F940WGOT (color)</td> </tr> <tr> <td>F940GOT-LWD</td> <td>F940GOT (black and white) Handy GOT (black and white)</td> </tr> <tr> <td>F940GOT-SWD</td> <td>F940GOT (color) Handy GOT (color)</td> </tr> <tr> <td>F930GOT-BWD (V)(H)</td> <td>F930GOT-K (blue) F930GOT (blue)</td> </tr> </tbody> </table> <p>d) Set CPU direct connection (RS-232C) or link connection (RS-422/RS-232C) of the GOT-F900.                      On the menu, select "View/Project"-"System Settings"-"Setup Data".</p> 	Terminal	Model name	F940WGOT-TWD (V)(H)	F940WGOT (color)	F940GOT-LWD	F940GOT (black and white) Handy GOT (black and white)	F940GOT-SWD	F940GOT (color) Handy GOT (color)	F930GOT-BWD (V)(H)	F930GOT-K (blue) F930GOT (blue)	<p>The "Project settings" dialog box appears.</p>
Terminal	Model name											
F940WGOT-TWD (V)(H)	F940WGOT (color)											
F940GOT-LWD	F940GOT (black and white) Handy GOT (black and white)											
F940GOT-SWD	F940GOT (color) Handy GOT (color)											
F930GOT-BWD (V)(H)	F930GOT-K (blue) F930GOT (blue)											

Operation		Display (screen name)									
	<p>e)Set the following.</p> <p>Port: RS-422 RS-232C</p> <p>Type: CPU LINK</p> <p>Station No. : 0 to 31 GOT Station No. : -</p> <p>Combinations of "Port" and "Type" are as follows.</p> <table border="1"> <thead> <tr> <th>Connection destination</th> <th>Port</th> <th>Type</th> </tr> </thead> <tbody> <tr> <td>NB-RS1-AC(RS-422/RS-232C) NJ-RS4(RS-422) NJ-RS2(RS-232C) NS-RS1(RS-422/RS-232C)</td> <td>RS-422/ RS-232C</td> <td>LINK</td> </tr> <tr> <td>NJ-CPU-B16(RS-232C)</td> <td>RS-232C</td> <td>CPU</td> </tr> </tbody> </table>	Connection destination	Port	Type	NB-RS1-AC(RS-422/RS-232C) NJ-RS4(RS-422) NJ-RS2(RS-232C) NS-RS1(RS-422/RS-232C)	RS-422/ RS-232C	LINK	NJ-CPU-B16(RS-232C)	RS-232C	CPU	<p>The "Setup Data" dialog box appears.</p>
Connection destination	Port	Type									
NB-RS1-AC(RS-422/RS-232C) NJ-RS4(RS-422) NJ-RS2(RS-232C) NS-RS1(RS-422/RS-232C)	RS-422/ RS-232C	LINK									
NJ-CPU-B16(RS-232C)	RS-232C	CPU									
[Change method]	<p>Change the connection type of the already created data as follows.</p> <p>a)Open DU/WIN.</p> <p>b)On the menu, select "File"-"Open".</p> <p>c)Select and open (read) the file of the screen data to be changed.</p> <p>d)When changing "Terminal" (GOT-F900), select "View/Project"-"System Settings"-"Project settings" on the menu.</p> <ul style="list-style-type: none"> <li>- For the contents of setting, refer to c) of [Creation] above.</li> <li>- For selection of the RS-422 or the RS-232C on the FLEX-PC-N Series PLCs, refer to e) of [Creation] above.</li> </ul>	<p>The "Open" dialog box appears.</p> <p>The "Project settings" dialog box appears.</p>									

11

Connection of MELSEC-Q Series PLC

12

Connection of FX Series Positioning

13

Connection of FREQROL Inverter

14

Connection of Microcomputer

15

Connection of SYSMAC C Series PLC

16

Connection of FLEX-PC N Series PLC

17

Connection of Machine Controller

18

Connection of FP Series PLC

19

Connection of SLC500 Series PLC

20

Connection of SIMATIC S7 Series PLC

## 16.6 Cable Diagram

This section explains cable diagrams to connect the GOT-F900 and the FLEX-PC N Series PLC manufactured by Fuji Electric.

### 16.6.1 Cautions on preparing cables

1) When preparing the cables, use the wire size of 0.08mm<sup>2</sup> or more (AWG28 or more) for communication, 0.3mm<sup>2</sup> or more (AWG22 or more) for the power supply, operation switch, and emergency stop switch.

2)  stands for a twisted pair cable. Prepare a twisted pair cable in combination of the pin numbers and signal lines described on the cable diagram.

Do not use a twisted pair cable with the power supply wire and the communication wire.

### 16.6.2 Cable diagram

#### 1) Cable for the GOT and the FLEX-PC N Series PLC manufactured by Fuji Electric

 : Female type  : Male type The connector figure shows the engagement face.

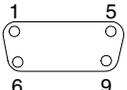
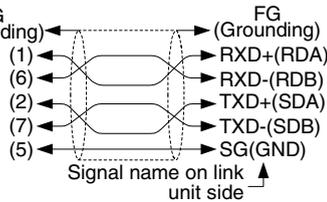
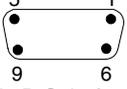
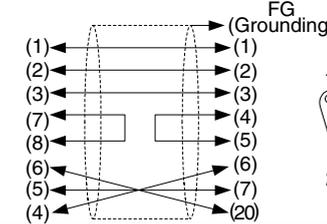
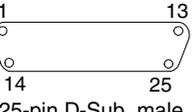
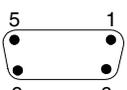
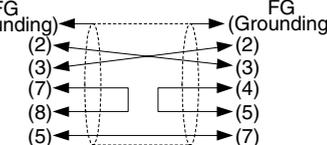
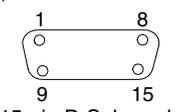
No.	Model name	Application	Connection diagram	Application
a)	<p>RS-422 connection</p> <p>FLEX-PC N Series Prepared by the user</p>	<p>To GOT-F900</p>  <p>9-pin D-Sub, male</p>	 <p>Signal name on link unit side ↑</p>	<p>Terminal block</p> <p>To link unit side (PLC side)</p>
b)	<p>RS-232C connection</p> <p>Prepared by the user</p>	<p>To GOT-F900</p>  <p>9-pin D-Sub, female</p>		<p>To link unit side (PLC side)</p>  <p>25-pin D-Sub, male</p>
c)	<p>RS-232C connection</p> <p>Prepared by the user</p>	<p>To GOT-F900</p>  <p>9-pin D-Sub, female</p>		<p>To PLC side</p>  <p>15-pin D-Sub, male</p>

2) Cable for the Handy GOT and the FLEX-PC N Series PLC manufactured by Fuji Electric

When using the Handy GOT RH model, refer to the cable diagrams below for the RS-422/RS-232C connector, but not the wiring for the power supply, the operation switches, and the emergency stop switch because it is different. For details, refer to Section 5.18.

 : Female type  : Male type The connector figure shows the engagement face.

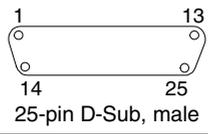
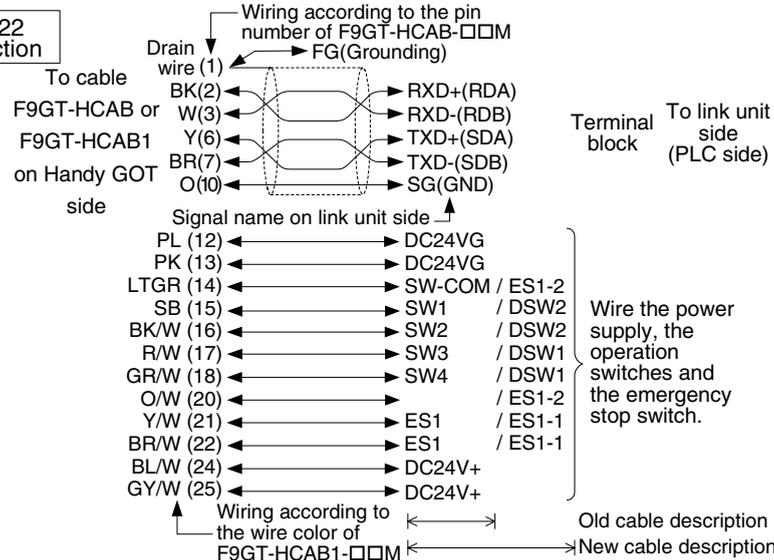
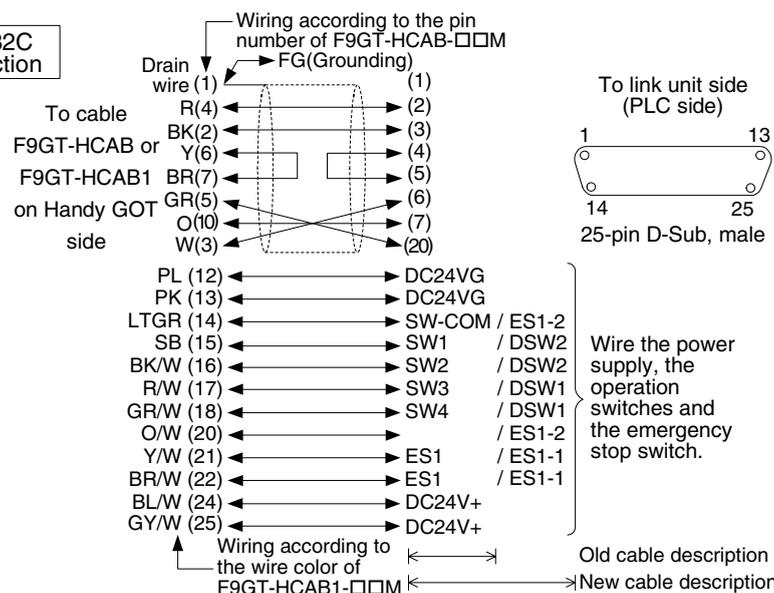
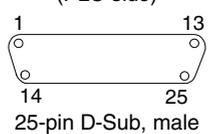
No.	Model name	Application	Connection diagram	Application
a)	F9GT-HCAB-3M F9GT-HCAB-10M	<div style="border: 1px solid black; padding: 2px; display: inline-block;">RS-422 connection</div> <div style="border: 1px solid black; padding: 2px; display: inline-block;">RS-232C connection</div> Dedicated connector on Handy GOT side	The connector on the leader side of the Handy GOT is dedicated, and cannot be prepared by the user.	To F9GT-HCAB3-150  1 13 14 25 25-pin D-Sub, male
b)	F9GT-HCAB1-3M F9GT-HCAB1-10M	<div style="border: 1px solid black; padding: 2px; display: inline-block;">RS-422 connection</div> <div style="border: 1px solid black; padding: 2px; display: inline-block;">RS-232C connection</div> Dedicated connector on Handy GOT side	The connector on the leader side of the Handy GOT is dedicated, and cannot be prepared by the user.	Loose wires (no connector)
c)	FLEX-PC N Series Prepared by the user	<div style="border: 1px solid black; padding: 2px; display: inline-block;">RS-422 connection</div>	 <p>Wiring according to the pin number of F9GT-HCAB-□□□M</p> <p>Wiring according to the wire color of F9GT-HCAB1-□□□M</p> <p>Old cable description</p> <p>New cable description</p>	Terminal block To link unit side (PLC side) Wire the power supply, the operation switches and the emergency stop switch.
d)	Prepared by the user	<div style="border: 1px solid black; padding: 2px; display: inline-block;">RS-232C connection</div>	 <p>Wiring according to the pin number of F9GT-HCAB-□□□M</p> <p>Wiring according to the wire color of F9GT-HCAB1-□□□M</p> <p>Old cable description</p> <p>New cable description</p>	To link unit side (PLC side)  1 13 14 25 25-pin D-Sub, male Wire the power supply, the operation switches and the emergency stop switch.

11	Connection of MELSEC-Q Series PLC
12	Connection of FX Series Positioning
13	Connection of FREQROL Inverter
14	Connection of Microcomputer
15	Connection of SYSMAC C Series PLC
16	Connection of FLEX-PC N Series PLC
17	Connection of Machine Controller
18	Connection of FP Series PLC
19	Connection of SLC500 Series PLC
20	Connection of SIMATIC S7 Series PLC

Female type Male type The connector figure shows the engagement face.

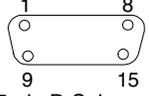
No.	Model name	Application	Connection diagram	Application
e)	Prepared by the user	<p>RS-232C connection</p> <p>To cable side</p> <p>Drain wire (1)</p> <p>R(4)</p> <p>BK(2)</p> <p>Y(6)</p> <p>BR(7)</p> <p>O(10)</p> <p>W(3)</p> <p>PL (12)</p> <p>PK (13)</p> <p>LTGR (14)</p> <p>SB (15)</p> <p>BK/W (16)</p> <p>R/W (17)</p> <p>GR/W (18)</p> <p>O/W (20)</p> <p>Y/W (21)</p> <p>BR/W (22)</p> <p>BL/W (24)</p> <p>GY/W (25)</p>	<p>Wiring according to the pin number of F9GT-HCAB-□□M</p> <p>FG(Grounding)</p> <p>(2)</p> <p>(3)</p> <p>(6)</p> <p>(4)</p> <p>(5)</p> <p>(7)</p> <p>DC24VG</p> <p>DC24VG</p> <p>SW-COM / ES1-2</p> <p>SW1 / DSW2</p> <p>SW2 / DSW2</p> <p>SW3 / DSW1</p> <p>SW4 / DSW1</p> <p>ES1 / ES1-2</p> <p>ES1 / ES1-1</p> <p>DC24V+</p> <p>DC24V+</p> <p>Wiring according to the wire color of F9GT-HCAB1-□□M</p>	<p>To PLC side</p>  <p>15-pin D-Sub, male</p> <p>Wire the power supply, the operation switches and the emergency stop switch.</p> <p>Old cable description</p> <p>New cable description</p>



## 16.7 Troubleshooting

For reference, this section summarizes frequently asked questions about connection of the GOT-F900 to the FLEX-PC N Series PLC.

### 1) GOT-F900

Contents of trouble	Check points and countermeasures	OS version		
		F940W	F940	F930
"COMMUNICATION ERROR OCCURS" is displayed when a screen changeover or numeric data input is performed on the GOT-F900 screen.	<p>The power of the FLEX-PC N Series PLC is turned off.</p> <ul style="list-style-type: none"> <li>• Cause Communication is disabled because the power of the FLEX-PC N Series PLC is turned off.</li> <li>• Countermeasures Turn on the power.</li> </ul>	From first product	From first product	From first product
	<p>Something is wrong with the cable between the GOT-F900 and the FLEX-PC N Series PLC.</p> <ul style="list-style-type: none"> <li>• Causes The wrong cable is used or the connection is bad.</li> <li>• Countermeasures Check the cable.</li> </ul>			
"DISPLAY SCREEN IS NOT AVAILABLE." is displayed on the GOT-F900 screen.	<p>Changeover to a nonexistent screen by a touch key or the FLEX-PC N Series PLC was tried.</p> <ul style="list-style-type: none"> <li>• Cause The changeover destination screen has not been created yet.</li> <li>• Countermeasures Create the screen.</li> </ul>	–	Earlier than 6.00	Earlier than 4.00
"DISPLAY SCREEN IS NOT AVAILABLE. (NO. ####)" is displayed on the GOT-F900 screen.	<p>A nonexistent screen was tried to be displayed.</p> <ul style="list-style-type: none"> <li>• Cause The screen No. #### has not been created yet.</li> <li>• Countermeasures Create the screen.</li> </ul>	From first product	6.00 or later	4.00 or later
"DISPLAY SCREEN IS NOT AVAILABLE." is displayed on the GOT-F900 screen.	<p>A device that does not exist in the FLEX-PC N Series PLC was referenced.</p> <ul style="list-style-type: none"> <li>• Cause On the changeover destination screen (excluding the head screen), a nonexistent device in the connected FLEX-PC N Series PLC is specified.</li> <li>• Countermeasures Check the devices used on the head screen.</li> </ul>	–	Earlier than 6.00	Earlier than 4.00
	<p>There is an error on the screen to be displayed.</p> <ul style="list-style-type: none"> <li>• Cause One of the screen objects is placed outside the available screen area.</li> <li>• Countermeasures Check the placement of screen objects.</li> </ul>			

Contents of trouble	Check points and countermeasures	OS version		
		F940W	F940	F930
"DISPLAY SCREEN IS NOT AVAILABLE. (NO. ####)" is displayed on the GOT-F900 screen.	<p>The display screen contains an error.</p> <ul style="list-style-type: none"> <li>Causes A device that does not exist in the connected PLC is referenced on the screen No. ####, or one of the screen objects is placed outside the available screen area.</li> <li>Countermeasures Check the devices used and placement of screen objects.</li> </ul>	From first product	6.00 or later	4.00 or later
"DATA IS NOT FOUND." is displayed on the GOT-F900 screen.	<p>There is not data because the unit is new or the memory clear has been executed.</p> <ul style="list-style-type: none"> <li>Cause There is no screen data.</li> <li>Countermeasures Write the screen data using the screen creation software.</li> </ul>	-	Earlier than 6.00	Earlier than 4.00
	<p>A device that does not exist in the FLEX-PC N Series PLC was referenced.</p> <ul style="list-style-type: none"> <li>Cause On the head screen, a nonexistent device in the connected FLEX-PC N Series PLC is specified. (The head screen is the screen No. 1 in the GT Designer, and the screen No. 0 in the DU/WIN.)</li> <li>Countermeasures Check the devices used on the head screen.</li> </ul>			
	<p>There is not data because the unit is new or the memory clear has been executed.</p> <ul style="list-style-type: none"> <li>Cause There is no screen data.</li> <li>Countermeasures Write the screen data using the screen creation software.</li> </ul>	From first product	6.00 or later	4.00 or later
"CAN NOT WRITE TO PLC MEMORY." is displayed on the GOT-F900 screen.	This error is not displayed.	Earlier than 1.10	Earlier than 6.10	Earlier than 4.10
"CAN NOT WRITE." is displayed on the GOT-F900 screen.	This error is not displayed.	1.10 or later	6.10 or later	4.10 or later
"CAN NOT USE THE FUNCTION WHILE PROTECTED." is displayed on the GOT-F900 screen.	This error is not displayed.	From first product	From first product	From first product
"PLC IS RUNNING." is displayed on the GOT-F900 screen.	This error is not displayed.	From first product	From first product	From first product

2) Software

	Contents of trouble	Check points and countermeasures
Screen creation software	Communication with the screen creation software and screen data cannot be transferred.	<p>A FLEX-PC N Series PLC, bar code reader or printer is connected.</p> <ul style="list-style-type: none"> <li>• Causes The RS-232C connector to which the personal computer is connected is set to be used for another piece of equipment.</li> <li>• Countermeasures In the GOT-F900, select by hand "SELECT MODE"- "OTHER MODE"- "DATA TRANSFER". Or set a bar code reader to invalid and a printer to "DON'T USE".</li> </ul>
		<p>Something is wrong with the cable between the GOT-F900 and the personal computer.</p> <ul style="list-style-type: none"> <li>• Causes The connected cable is not proper. Or cable connection is not correct.</li> <li>• Countermeasures Check the cable.</li> </ul>

11

Connection of MELSEC-Q Series PLC

12

Connection of FX Series Positioning

13

Connection of FREQROL Inverter

14

Connection of Microcomputer

15

Connection of SYSMAC C Series PLC

16

Connection of FLEX-PC N Series PLC

17

Connection of Machine Controller

18

Connection of FP Series PLC

19

Connection of SLC500 Series PLC

20

Connection of SIMATIC S7 Series PLC

## **MEMO**

## 17. Connection of Machine Controller CP9200SH (PLC Manufactured by Yaskawa Electric)

This chapter explains the procedure to connect the GOT-F900 Series display unit to the MP900/CP9200SH machine controller.

### Connection Procedure

This section introduces the procedure to connect the GOT-F900 to the MP900/CP9200SH machine controller.

#### 1. Preparation

Item name	Description	Reference
System Condition	You can learn the connection availability as well as the version of the GOT-F900 OS and the screen creation software.	17.1
System Configuration	You can select the configuration between the GOT and the machine controller MP900/CP9200SH and proper cables.	17.2

#### 2. Setting

Item name	Description	Reference	
Setting in Machine Controller	You can learn the communication specifications and the contents of setting.	17.3	
	<table border="1"> <tr> <td>Communication Setting Specifications</td> <td>The communication specifications set in the machine controller.</td> <td>17.3.1</td> </tr> </table>		Communication Setting Specifications
Communication Setting Specifications	The communication specifications set in the machine controller.	17.3.1	
Setting of Connected Equipment for GOT	Set the PLC type using the GOT or the screen creation software.	17.4	

#### 3. Others

Item name	Description	Reference
Cable Diagram	Cable diagrams for Machine controller/GOT connection	17.5
Troubleshooting	Description of errors and how to fix them	17.6

### 17.1 System Condition

When connecting the machine controller MP900/CP9200SH, check the COM port designation, the OS version of the GOT-F900, and applicable versions of the screen creation software.

Compatibility when connecting Machine Controller CP9200SH

GOT-F900 Series	COM port		Connection type		OS version of GOT-F900	Version of screen creation software		
	RS-422	RS-232C	1:1	Two or more GOT units		GT Designer2	GT Designer	DU/WIN
F920GOT-K	–	–	–	–	–	–	–	–
F930GOT	✓	✓	✓	–	3.00	SW1-C	SW4-F	–
F930GOT-K	✓	✓	✓	–	4.60	SW1-C	SW5-26C	–
F940GOT	✓	✓	✓	–	5.00	SW1-C	SW4-F	–
F940WGOT	✓	✓	✓	–	1.00	SW1-C	SW5-F	–
F940 Handy GOT	✓	–	✓	–	5.00	SW1-C	SW4-F	–
F943 Handy GOT	–	✓	✓	–	5.00	SW1-C	SW4-F	–

- The screen creation software version corresponds to connection of the machine controller CP9200SH. Refer to section 3.2.

## 17.2 System Configuration

The MP900/CP9200SH machine controller can be directly connected to the GOT via RS-422 or RS-232C. This section explains the cables and options required in such a system.

### 17.2.1 Applicable model

The GOT-F900 can be connected to the following equipment in accordance with its OS version. Operations are not assured when the GOT-F900 is connected to any other equipment.

For details of the OS version of the GOT-F900 and applicable equipment, refer to "3.1 OS Version and Correspondence to Connected Equipment of GOT-F900".

CPU	OPTION	COMMUNICATION PORT
CP9200SH	CP-217IF	Connection to MEMOBUS unit
MP920	–	Connection to Built-in RS-232C port
	CP-217IF	Connection to MEMOBUS unit
MP930	–	Connection to Built-in RS-232C port

### Connectable Model and Connector Shape

The table below shows applicable models and their connector shape.

Machine controller					Remarks
Model	Unit	Port		Connector shape	
CP9200SH	CP-217IF	CN1	RS-232C	9-pin D-Sub, male	MEMOBUS unit
		CN2	RS-232C	25-pin D-Sub, male	
		CN3	RS-422	8-pin connector, male	
MP920	CPU equipped with built-in ports	PORT1	RS-232C	9-pin D-Sub, male	Built-in port
		PORT2	RS-232C	9-pin D-Sub, male	
	CP-217IF	CN1	RS-232C	9-pin D-Sub, male	MEMOBUS unit
		CN2	RS-232C	9-pin D-Sub, male	
		CN3	RS-422	8-pin connector, male	
MP930	CPU equipped with built-in ports	PORT1	RS-232C	9-pin D-Sub, male	Built-in port
		PORT2	RS-232C	9-pin D-Sub, male	

### 17.2.2 Configuration for CPU Direct Connection (RS-422)

Connect the MP900/CP9200SH machine controller to the COM port of the MEMOBUS unit and the RS-422 communication port of the GOT.

The GOT-F900 and the machine controller can be connected on the 1:1 basis.

#### 1) F930GOT/F930GOT-K/F940GOT/F940WGOT

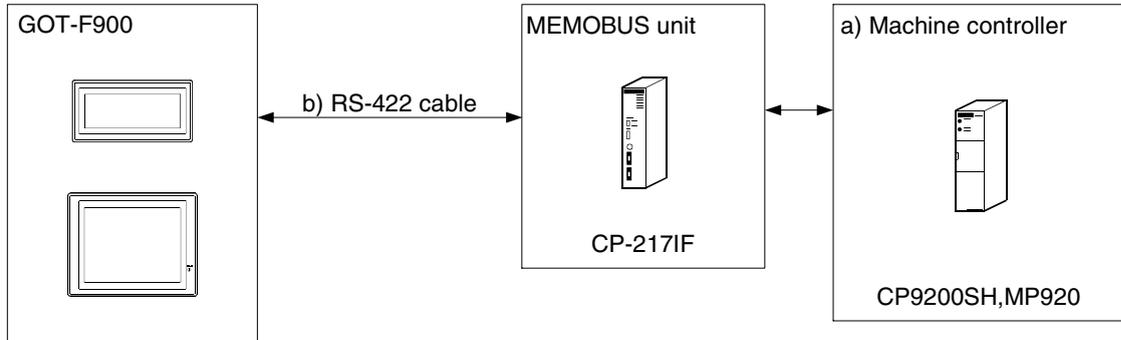

a) Machine controller	MEMOBUS unit		b) RS-422 cable	Remarks
CP9200SH	CP-217IF	Dedicated 8-pin connector	Prepared by the user	
MP920				

- Applicable machine controller product in the column a) is a MEMOBUS unit equipped with built-in RS-422 interface.

11 Connection of MELSEC-Q Series PLC

12 Connection of FX Series Positioning

13 Connection of FREQROL Inverter

14 Connection of Micro-computer

15 Connection of SYSMAC C Series PLC

16 Connection of FLEX-PC N Series PLC

17 Connection of Machine Controller

18 Connection of FP Series PLC

19 Connection of SLC500 Series PLC

20 Connection of SIMATIC S7 Series PLC

2) F940 Handy GOT

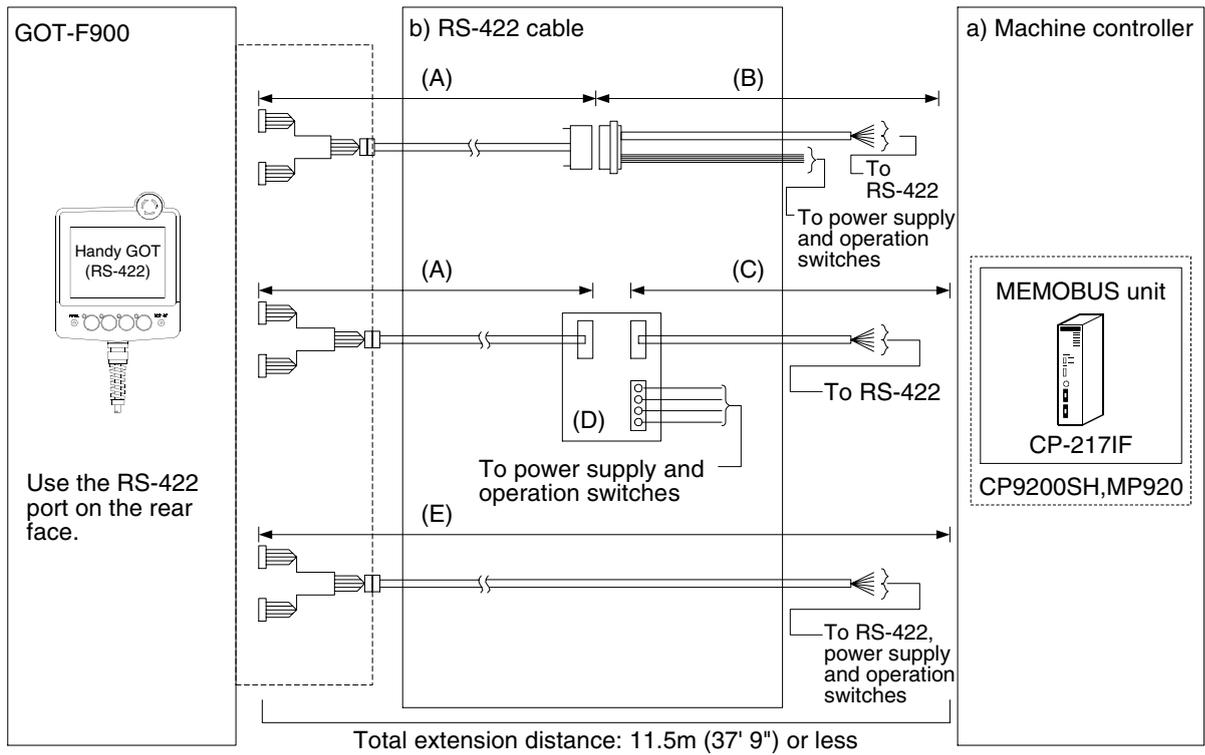

a) Machine controller	MEMOBUS unit		b) RS-422 cable	Remarks
CP9200SH MP920	CP-217IF	Dedicated 8-pin connector	(A) F9GT-HCAB-□□□ (B) Prepared by the user (C) Prepared by the user (D) F9GT-HCNB (E) F9GT-HCAB1-□□□	

- Applicable machine controller product in the column a) is a MEMOBUS unit equipped with built-in RS-422 interface.



### 17.2.3 Configuration for CPU Direct Connection (RS-232C)

Connect the MP900/CP9200SH machine controller to the MEMOBUS port built in the CPU unit or the COM port of the MEMOBUS unit and the RS-232C communication port of the GOT. The GOT-F900 and the machine controller can be connected on the 1:1 basis.

#### 1) F930GOT/F930GOT-K/F940GOT/F940WGOT

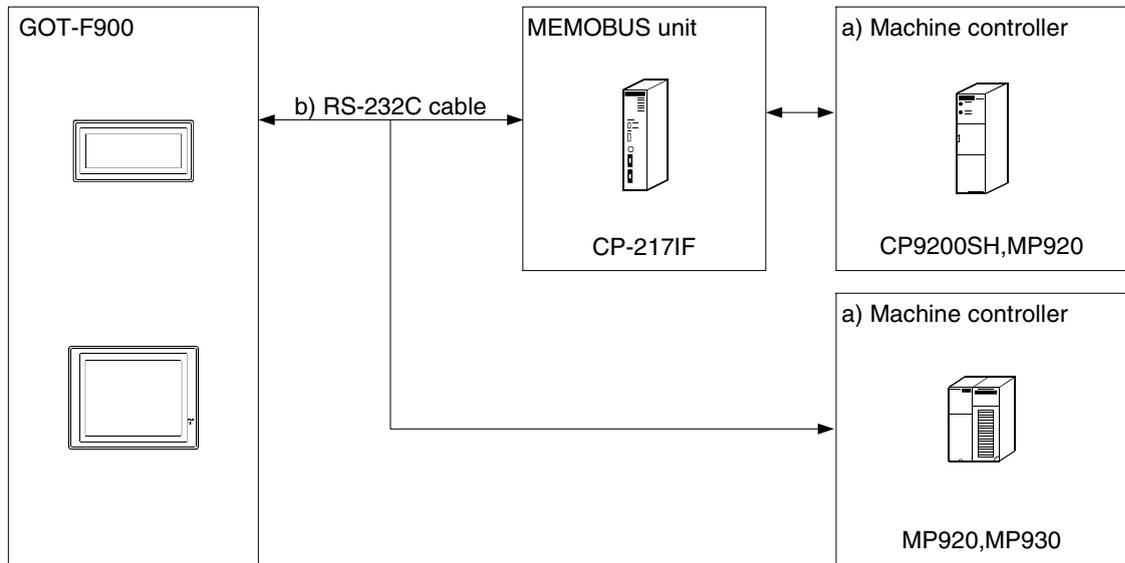

a) Machine controller	MEMOBUS unit		b) RS-422 cable	Remarks
CP9200SH	CP-217IF	9-pin D-Sub <sup>*1</sup> 25-pin D-Sub	Prepared by the user	
MP920	-			Connection to Built-in RS-232C port
	CP-217IF	9-pin D-Sub <sup>*1</sup> 25-pin D-Sub		
MP930	-			Connection to Built-in RS-232C port

- Applicable machine controller products in the column a) are CPU or MEMOBUS units equipped with built-in RS-232C interface.

\*1 In the CP-217IF, the COM1 is the 9-pin D-Sub port and the COM2 is the 25-pin D-Sub port. (The COM3 is an RS-422 port.)

2) F943 Handy GOT

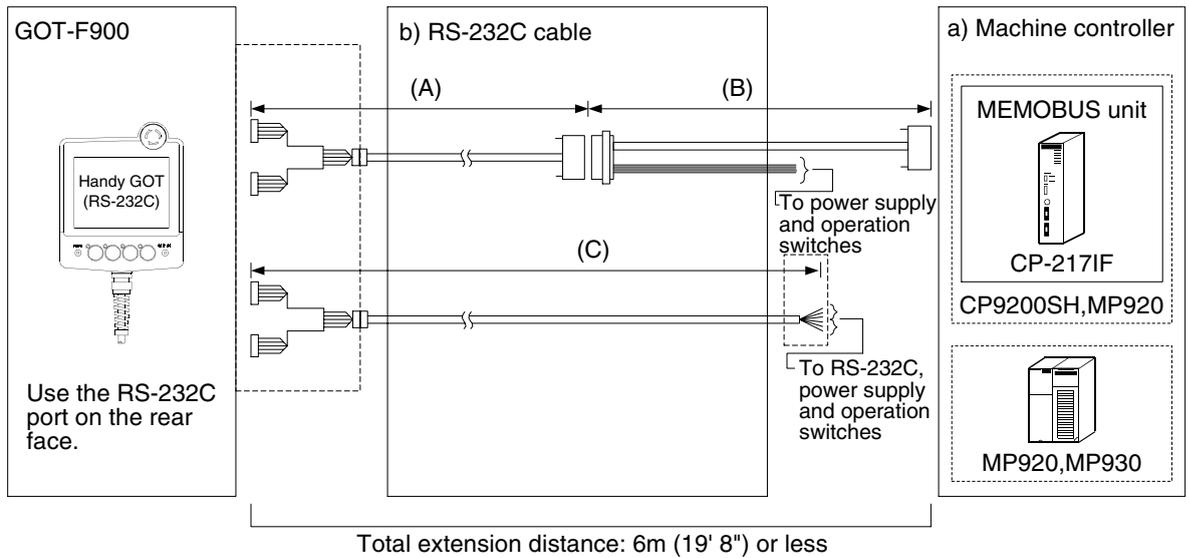

a) Machine controller	MEMOBUS unit		b) RS-422 cable	Remarks
CP9200SH	CP-217IF	9-pin D-Sub <sup>*1</sup> 25-pin D-Sub	(A) F9GT-HCAB-3M (B) Prepared by the user (C) F9GT-HCAB1-□□M	
MP920	-			Connection to Built-in RS-232C port
	CP-217IF	9-pin D-Sub <sup>*1</sup> 25-pin D-Sub		
MP930	-		Connection to Built-in RS-232C port	

- Applicable machine controller products in the column a) are CPU or MEMOBUS units equipped with built-in RS-232C interface.

\*1 In the CP-217IF, the COM1 is the 9-pin D-Sub port and the COM2 is the 25-pin D-Sub port. (The COM3 is an RS-422 port.)

## 17.3 Setting in Machine Controller

When connecting the MP900/CP9200SH machine controller, the communication setting of the MEMOBUS port should be changed using peripheral equipment.

### 17.3.1 Communication Setting Specifications

#### 1) Setting the transmission specifications

Set the transmission specifications in the MP900/CP9200SH machine controller as shown in the table below. For the setting method, refer to the manual of the machine controller.

Item		Set value
Protocol		MEMOBUS
Mode		RTU
Slave address		1 to 16
Transmission speed		19200 bps
Data format	Data bit	8 bits
	Parity bit	Provided (even)
	Stop bit	1 bit

- The specifications such as the transmission speed are fixed on the GOT-F900 side, and cannot be changed.

#### 2) Setting the slave address (station number) setting switch

The slave address is regarded as the station number in the GOT-F900.  
Align the slave address setting switch to the value (1 to 16) set in the GOT-F900.  
If the station number of the GOT-F900 is set to "00", it is treated as "01".

11

Connection of  
MELSEC-Q  
Series PLC

12

Connection of  
FX Series  
Positioning

13

Connection of  
FREQUOL  
Inverter

14

Connection of  
Microcom-  
puter

15

Connection of  
SYSMAC C  
Series PLC

16

Connection of  
FLEX-PC N  
Series PLC

17

Connection of  
Machine Con-  
troller

18

Connection of  
FP Series PLC

19

Connection of  
SLC500  
Series PLC

20

Connection of  
SIMATIC S7  
Series PLC

## 17.4 Setting of Connected Equipment for GOT

The setting for connection to the machine controller MP900/CP9200SH can be executed using the GOT-F900 and the screen creation software (GT Designer2, GT Designer or DU/WIN).

### 1) GOT-F900 Series

When the main menu screen change operation is disabled.

Operation	Display (screen name)
a) While pressing and holding the upper left corner of the screen, turn on the power. Keep holding the upper left corner for about 25 seconds more. Then, press "END" at the upper right corner.	The "LANGUAGE" screen appears.
b) Press "PLC TYPE".	The "SET-UP MODE" screen appears.
c) Set the following. PLC TYPE: YASKAWA CP9200SH CONNECTION: CPU PORT (RS-422) CPU PORT (RS-232C) DST STATION # (STATION #) : 01 to 16 ("00" is treated as "01".) GOT STATION # (-) : -	The "PLC TYPE" screen appears.

When the main menu screen change operation is enabled.

Operation	Display (screen name)
a) Press the upper left corner of the screen. (The position to be pressed can be changed in the GOT and the screen creation software.)	The "SELECT MODE" screen appears.
b) Press "OTHER MODE" on the menu.	The "OTHER MODE" screen appears.
c) Press "SET-UP MODE" on the menu.	The "SET-UP MODE" screen appears.
d) Press "PLC TYPE".	The "PLC TYPE" screen appears.
e) Set the following. PLC TYPE: YASKAWA CP9200SH CONNECTION: CPU PORT (RS-422) CPU PORT (RS-232C) DST STATION # (STATION #) : 01 to 16 ("00" is treated as "01".) GOT STATION # (-) : -	

- When the screen data is transferred to the GOT-F900, the old data including the PLC type, connection type, and station number are overwritten.

2) GT Designer2

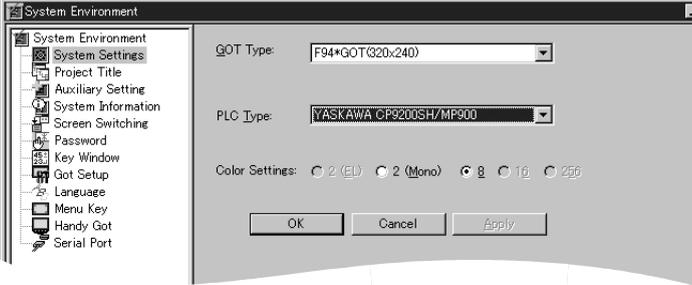
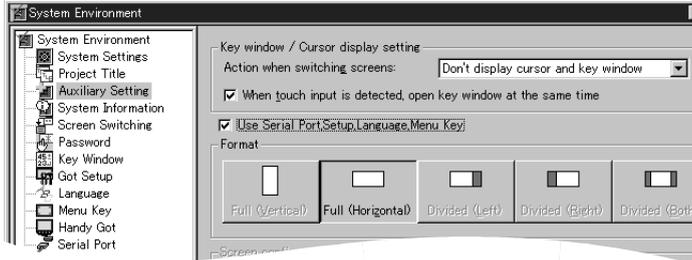
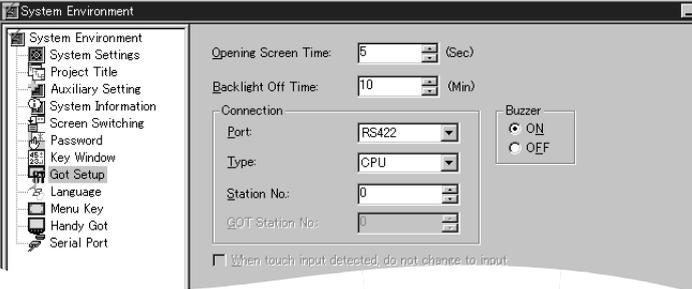
	Operation	Display (screen name)								
[Creation]	<p>a) Open GT Designer2.</p> <p>b) Click the [NEW] button. The dialog box shown below is displayed. If it is not displayed, click "System Environment" in the tree displayed in the project work space, then click "System settings" in the tree.</p>  <p>c) Set the following. GOT type: F940WGOT (480 × 234) F94*GOT (320 × 240) F93*GOT (240 × 80) PLC type: YASKAWA CP9200SH/MP900 Selection of "GOT type"</p> <table border="1" data-bbox="483 1025 1114 1247"> <thead> <tr> <th>GOT type</th> <th>Model name (name)</th> </tr> </thead> <tbody> <tr> <td>F940WGOT(480×234)&lt;WIDE&gt;</td> <td>F940WGOT</td> </tr> <tr> <td>F94*GOT(320×240)</td> <td>F940GOT Handy GOT</td> </tr> <tr> <td>F93*GOT(240×80)</td> <td>F930GOT F930GOT-K</td> </tr> </tbody> </table> <p>Click [OK].</p> <p>d) Setting the port (RS-422 or RS-232C) of the GOT-F900 Click "Auxiliary Setting" in the tree of the system environment menu. Click the check box of "Use Serial Port, Setup, Language, Menu Key" to give a check mark (✓).</p>  <p>Click "Got Setup" in the tree of the system environment menu.</p> 	GOT type	Model name (name)	F940WGOT(480×234)<WIDE>	F940WGOT	F94*GOT(320×240)	F940GOT Handy GOT	F93*GOT(240×80)	F930GOT F930GOT-K	<p>The "Select Project" dialog box appears.</p> <p>The "System Environment" dialog box appears.</p> <p>The "Auxiliary Settings" dialog box appears.</p>
GOT type	Model name (name)									
F940WGOT(480×234)<WIDE>	F940WGOT									
F94*GOT(320×240)	F940GOT Handy GOT									
F93*GOT(240×80)	F930GOT F930GOT-K									

	Operation	Display (screen name)
	e)Set the following. Port : RS-422 RS-232C Type : CPU Station No. : 01 to 16 ("00" is treated as "01".) GOT Station No. : – <u>In the case of F943 Handy GOT</u> Without regard to the port setting (RS-422 or RS-232C), the COM0 side of the RS-232C is fixed for PLC connection.	
[Change method]	Change the connection type of the already created data as follows. a)Open GT Designer2. b)Click the [Project]-[Open] button. c)Open (read) the screen data to be changed. d)On the menu, select "Common"- "System Environment". - For the contents of setting, refer to c) of [Creation] above. - For selection of the RS-422 or the RS-232C on the Machine Controller PLCs, refer to e) of [Creation] above.	The "Select Project" dialog box appears.  The "System Environment" dialog box appears.



Operation		Display (screen name)
	<p>In the case of SW4D5C-GOTR-PACKE earlier than version A, perform the setting in the GOT-F900. (Set the connection in "CONNECTION" in the GOT-F900.) For the setting method, refer to "1) GOT-F900 Series" on the previous page.</p> <p>e) Set the following.</p> <p>Port : RS-422 RS-232C</p> <p>Type : CPU</p> <p>DST Station No. (Station No.): 01 to 16 ("00" is treated as "01".) GOT Station No. (-) : -</p>	
[Change method]	<p>Change the connection type of the already created data as follows.</p> <p>a) Open GT Designer.</p> <p>b) Click the [Open] button.</p> <p>c) Open (read) the screen data to be changed.</p> <p>d) On the menu, select "Common"-&gt;"GOT/PLC Type". - For the contents of setting, refer to c) of [Creation] above. - For selection of the RS-422 or the RS-232C on the Machine Controller PLCs, refer to e) of [Creation] above.</p>	<p>The "Select Project" dialog box appears.</p> <p>The "GOT/PLC Type" dialog box appears.</p>



## 17.5 Cable Diagram

This section explains cable diagrams to connect the GOT-F900 and the MP900/CP9200SH machine controller.

### 17.5.1 Cautions on preparing cables

1) When preparing the cables, use the wire size of 0.08mm<sup>2</sup> or more (AWG28 or more) for communication, 0.3mm<sup>2</sup> or more (AWG22 or more) for the power supply, operation switch, and emergency stop switch.

2)  stands for a twisted pair cable. Prepare a twisted pair cable in combination of the pin numbers and signal lines described on the cable diagram.

Do not use a twisted pair cable with the power supply wire and the communication wire.

### 17.5.2 Cable diagram

#### 1) Cable for the GOT and the machine controller

 : Female type   
  : Male type   
 The connector figure shows the engagement face.

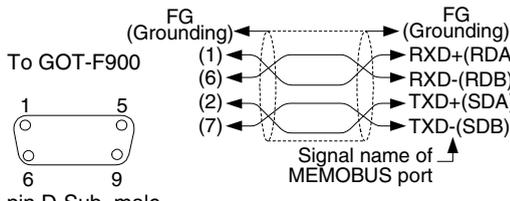
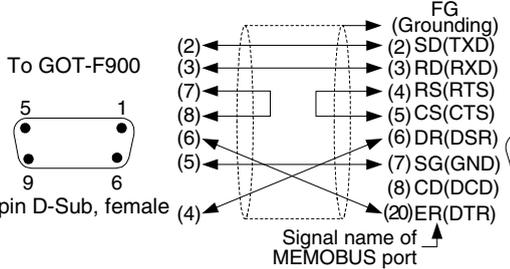
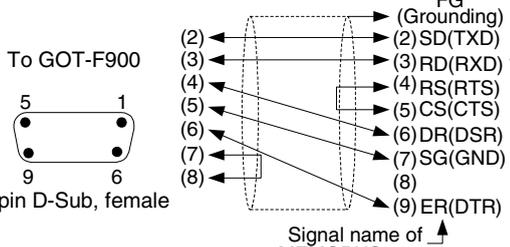
No.	Model name	Application	Connection diagram	Application
a)	RS-422 connection Machine controller CP-217IF Prepared by the user	To GOT-F900		To CP-217IF MEMOBUS unit CN3
b)	RS-232C connection Machine controller CP-217IF Prepared by the user	To GOT-F900		To CP-217IF MEMOBUS unit CN2
c)	RS-232C connection MP920, MP930, CP-217IF Prepared by the user	To GOT-F900		To MEMOBUS unit, CPU unit

2) Cable for the Handy GOT and the machine controller

When using the Handy GOT RH model, refer to the cable diagrams below for the RS-422/RS-232C connector, but not the wiring for the power supply, the operation switches, and the emergency stop switch because it is different. For details, refer to Section 5.18.

 : Female type  : Male type The connector figure shows the engagement face.

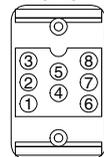
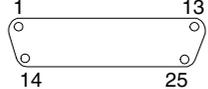
No.	Model name	Application	Connection diagram	Application	
a)	F9GT-HCAB-3M F9GT-HCAB-10M	<div style="border: 1px solid black; padding: 2px; display: inline-block;">RS-422 connection</div> <div style="border: 1px solid black; padding: 2px; display: inline-block;">RS-232C connection</div>	Dedicated connector on Handy GOT side	The connector on the leader side of the Handy GOT is dedicated, and cannot be prepared by the user.	To F9GT-HCAB3-150  25-pin D-Sub, male
b)	F9GT-HCAB1-3M F9GT-HCAB1-10M	<div style="border: 1px solid black; padding: 2px; display: inline-block;">RS-422 connection</div> <div style="border: 1px solid black; padding: 2px; display: inline-block;">RS-232C connection</div>	Dedicated connector on Handy GOT side	The connector on the leader side of the Handy GOT is dedicated, and cannot be prepared by the user.	Untied cable
c)	Machine controller CP-217IF Prepared by the user	<div style="border: 1px solid black; padding: 2px; display: inline-block;">RS-422 connection</div>	Wiring according to the pin number of F9GT-HCAB-□□□M Drain wire (1) → FG (Grounding) To cable side: BK(2), W(3), Y(6), BR(7) On Handy GOT side: (2)RXD+(RDA), (1)RXD-(RDB), (7)TXD+(SDA), (6)TXD-(SDB)	To CP-217IF MEMOBUS unit CN3  8-pin, male Wire the power supply, the operation switches and the emergency stop switch.	
			Signal name of MEMOBUS port PL (12) ↔ DC24VG PK (13) ↔ DC24VG LTGR (14) ↔ SW-COM / ES1-2 SB (15) ↔ SW1 / DSW2 BK/W (16) ↔ SW2 / DSW2 R/W (17) ↔ SW3 / DSW1 GR/W (18) ↔ SW4 / DSW1 O/W (20) ↔ / ES1-2 Y/W (21) ↔ ES1 / ES1-1 BR/W (22) ↔ ES1 / ES1-1 BL/W (24) ↔ DC24V+ GY/W (25) ↔ DC24V+	Old cable description New cable description	
d)	Machine controller CP-217IF Prepared by the user	<div style="border: 1px solid black; padding: 2px; display: inline-block;">RS-232C connection</div>	Wiring according to the pin number of F9GT-HCAB-□□□M Drain wire (1) → FG (Grounding) To cable side: R(4), BK(2), Y(6), BR(7), GR(5), O(10), W(3) On Handy GOT side: (1)FG (Drain wire), (2)SD(TXD), (3)RD(RXD), (4)RS(RTS), (5)CS(CTS), (6)DR(DSR), (7)SG(GND), (8)CD(DCD), (20)ER(DTR)	To CP-217IF MEMOBUS unit CN2  25-pin D-Sub, male Wire the power supply, the operation switches and the emergency stop switch.	
			Signal name of MEMOBUS port PL (12) ↔ DC24VG PK (13) ↔ DC24VG LTGR (14) ↔ SW-COM / ES1-2 SB (15) ↔ SW1 / DSW2 BK/W (16) ↔ SW2 / DSW2 R/W (17) ↔ SW3 / DSW1 GR/W (18) ↔ SW4 / DSW1 O/W (20) ↔ / ES1-2 Y/W (21) ↔ ES1 / ES1-1 BR/W (22) ↔ ES1 / ES1-1 BL/W (24) ↔ DC24V+ GY/W (25) ↔ DC24V+	Old cable description New cable description	

: Female type : Male type The connector figure shows the engagement face.

No.	Model name	Application	Connection diagram	Application
e)	MP920, MP930, CP-217IF Prepared by the user	RS-232C connection	<p>Wiring according to the pin number of F9GT-HCAB-□□□□</p> <p>Drain wire (1) → FG (Grounding) R (4) → SD (TXD) W (3) → RD (RXD) O (10) → RS (RTS) GR (5) → CS (CTS) Y (6) → DR (DSR) BR (7) → SG (GND) → CD (DCD) → ER (DTR)</p> <p>Signal name of MEMOBUS port</p> <ul style="list-style-type: none"> <li>PL (12) ↔ DC24VG</li> <li>PK (13) ↔ DC24VG</li> <li>LTGR (14) ↔ SW-COM / ES1-2</li> <li>SB (15) ↔ SW1 / DSW2</li> <li>BK/W (16) ↔ SW2 / DSW2</li> <li>R/W (17) ↔ SW3 / DSW1</li> <li>GR/W (18) ↔ SW4 / DSW1</li> <li>O/W (20) ↔ / ES1-2</li> <li>Y/W (21) ↔ ES1 / ES1-1</li> <li>BR/W (22) ↔ ES1 / ES1-1</li> <li>BL/W (24) ↔ DC24V+</li> <li>GY/W (25) ↔ DC24V+</li> </ul> <p>Wiring according to the wire color of F9GT-HCAB1-□□□□</p> <p>Old cable description ↔ New cable description</p> <p>To MEMOBUS unit CPU unit</p> <p>9-pin D-Sub, male</p> <p>Wire the power supply, the operation switches and the emergency stop switch.</p>	
f)	Machine controller CP-217IF Prepared by the user	RS-422 connection	<p>FG (Grounding) → FG (Grounding) (1) → (2) RXD+ (RDA) (6) → (1) RXD- (RDB) (2) → (7) TXD+ (SDA) (7) → (6) TXD- (SDB)</p> <p>Signal name of MEMOBUS port</p> <p>To F9GT-HCNB</p> <p>9-pin D-Sub, male</p> <p>To CP-217IF MEMOBUS unit CN3</p> <p>8-pin, male</p>	

11	Connection of MELSEC-Q Series PLC
12	Connection of FX Series Positioning
13	Connection of FREQROL Inverter
14	Connection of Microcomputer
15	Connection of SYMAC C Series PLC
16	Connection of FLEX-PC N Series PLC
17	Connection of Machine Controller
18	Connection of FP Series PLC
19	Connection of SLC500 Series PLC
20	Connection of SIMATIC S7 Series PLC

## 17.6 Troubleshooting

For reference, this section summarizes frequently asked questions about connection of the GOT-F900 to the MP900/CP9200SH machine controller.

### 1) GOT-F900

Contents of trouble	Check points and countermeasures	OS version		
		F940W	F940	F930
"COMMUNICATION ERROR OCCURS" is displayed when a screen changeover or numeric data input is performed on the GOT-F900 screen.	<p>The power of the machine controller is turned off.</p> <ul style="list-style-type: none"> <li>• Cause Communication is disabled because the power of the machine controller is turned off.</li> <li>• Countermeasures Turn on the power.</li> </ul>	From first product	From first product	From first product
	<p>Something is wrong with the cable between the GOT-F900 and the machine controller.</p> <ul style="list-style-type: none"> <li>• Causes The wrong cable is used or the connection is bad.</li> <li>• Countermeasures Check the cable.</li> </ul>			
"DISPLAY SCREEN IS NOT AVAILABLE." is displayed on the GOT-F900 screen.	<p>Changeover to a nonexistent screen by a touch key or the machine controller was tried.</p> <ul style="list-style-type: none"> <li>• Cause The changeover destination screen has not been created yet.</li> <li>• Countermeasures Create the screen.</li> </ul>	–	Earlier than 6.00	Earlier than 4.00
"DISPLAY SCREEN IS NOT AVAILABLE. (NO. ####)" is displayed on the GOT-F900 screen.	<p>A nonexistent screen was tried to be displayed.</p> <ul style="list-style-type: none"> <li>• Cause The screen No. #### has not been created yet.</li> <li>• Countermeasures Create the screen.</li> </ul>	From first product	6.00 or later	4.00 or later
"DISPLAY SCREEN IS NOT AVAILABLE." is displayed on the GOT-F900 screen.	<p>A device that does not exist in the machine controller was referenced. (Example: While a MP900 is connected, a device exists only in the CP9200SH is specified for numeric input.)</p> <ul style="list-style-type: none"> <li>• Cause On the changeover destination screen (excluding the head screen), a nonexistent device in the connected machine controller is specified.</li> <li>• Countermeasures Check devices used on the head screen.</li> </ul>	–	Earlier than 6.00	Earlier than 4.00
	<p>There is an error on the screen to be displayed.</p> <ul style="list-style-type: none"> <li>• Cause One of the screen objects is placed outside the available screen area.</li> <li>• Countermeasures Check the placement of screen objects.</li> </ul>			

Contents of trouble	Check points and countermeasures	OS version		
		F940W	F940	F930
"DISPLAY SCREEN IS NOT AVAILABLE. (NO. ####)" is displayed on the GOT-F900 screen.	<p>The display screen contains an error.</p> <ul style="list-style-type: none"> <li>Causes A device that does not exist in the connected PLC is referenced on the screen No. ####, or one of the screen objects is placed outside the available screen area.</li> <li>Countermeasures Check the devices used and placement of screen objects.</li> </ul>	From first product	6.00 or later	4.00 or later
"DATA IS NOT FOUND." is displayed on the GOT-F900 screen.	<p>There is not data because the unit is new or the memory clear has been executed.</p> <ul style="list-style-type: none"> <li>Cause There is no screen data.</li> <li>Countermeasures Write the screen data using the screen creation software.</li> </ul>	-	Earlier than 6.00	Earlier than 4.00
	<p>A device that does not exist in the machine controller was referenced. (Example: While a MP900 is connected, a device exists only in the CP9200SH is specified for numeric input.)</p> <ul style="list-style-type: none"> <li>Cause On the head screen, a nonexistent device in the connected machine controller is specified. (The head screen is the screen No. 1 in the GT Designer, and the screen No. 0 in the DU/WIN.)</li> <li>Countermeasures Check the devices used on the head screen.</li> </ul>			
	<p>There is not data because the unit is new or the memory clear has been executed.</p> <ul style="list-style-type: none"> <li>Cause There is no screen data.</li> <li>Countermeasures Write the screen data using the screen creation software.</li> </ul>			
"CAN NOT WRITE TO PLC MEMORY." is displayed on the GOT-F900 screen.	This error is not displayed.	Earlier than 1.10	Earlier than 6.10	Earlier than 4.10
"CAN NOT WRITE." is displayed on the GOT-F900 screen.	This error is not displayed.	1.10 or later	6.10 or later	4.10 or later
"CAN NOT USE THE FUNCTION WHILE PROTECTED." is displayed on the GOT-F900 screen.	This error is not displayed.	From first product	From first product	From first product
"PLC IS RUNNING." is displayed on the GOT-F900 screen.	This error is not displayed.	From first product	From first product	From first product

11

Connection of  
MELSEC-Q  
Series PLC

12

Connection of  
FX Series  
Positioning

13

Connection of  
FREQROL  
Inverter

14

Connection of  
Microcom-  
puter

15

Connection of  
SYSMAC C  
Series PLC

16

Connection of  
FLEX-PC N  
Series PLC

17

Connection of  
Machine Con-  
troller

18

Connection of  
FP Series PLC

19

Connection of  
SLC500  
Series PLC

20

Connection of  
SIMATIC S7  
Series PLC

## 2) Software

	Contents of trouble	Check points and countermeasures
Screen creation software	Communication with the screen creation software and screen data cannot be transferred.	<p>A machine controller, bar code reader or printer is connected.</p> <ul style="list-style-type: none"> <li>• Causes The RS-232C connector to which the personal computer is connected is set to be used for another piece of equipment.</li> <li>• Countermeasures In the GOT-F900, select by hand "SELECT MODE"-"OTHER MODE"-"DATA TRANSFER". Or set o bar code reader to invalid and a printer to "DON'T USE".</li> </ul> <p>Something is wrong with the cable between the GOT-F900 and the personal computer.</p> <ul style="list-style-type: none"> <li>• Causes The connected cable is not proper. Or cable connection is not correct.</li> <li>• Countermeasures Check the cable.</li> </ul>

## 18. Connection of FP Series PLC (Manufactured by Matsushita Electric Works)

This chapter explains connection of the GOT-F900 Series display unit to the FP Series PLC manufactured by Matsushita Electric Works.

### Connection Procedure

This section introduces the procedure to connect the GOT-F900 to the FP Series PLC.

#### 1. Preparation

Item name	Description	Reference
System Condition	You can learn the connection availability as well as the version of the GOT-F900 OS and the screen creation software.	18.1
System Configuration	You can select the configuration between the GOT and the FP Series PLC and proper cables.	18.2

#### 2. Setting

Item name	Description	Reference						
FP Selection	You can learn the communication specifications and the contents of setting.	18.3						
	<table border="1"> <tr> <td>Communication Setting Specifications</td> <td>The communication specifications between the FP Series PLC and the GOT unit.</td> <td>18.3.1</td> </tr> <tr> <td>Setting Examples</td> <td>The contents and position of setting in each FP Series PLC.</td> <td>18.3.2</td> </tr> </table>		Communication Setting Specifications	The communication specifications between the FP Series PLC and the GOT unit.	18.3.1	Setting Examples	The contents and position of setting in each FP Series PLC.	18.3.2
	Communication Setting Specifications		The communication specifications between the FP Series PLC and the GOT unit.	18.3.1				
Setting Examples	The contents and position of setting in each FP Series PLC.	18.3.2						
Cautions on Use of FP Series	You can learn the restrictions in connecting the GOT to the FP Series PLC.	18.4						
Setting of Connected Equipment for GOT	Set the PLC type using the GOT or the screen creation software.	18.5						

#### 3. Others

Item name	Description	Reference
Cable Diagram	Cable diagrams for FP Series PLC/GOT connection	18.6
Troubleshooting	Description of errors and how to fix them	18.7

## 18.1 System Condition

When connecting the FP Series PLC, check the COM port designation, the OS version of the GOT-F900, and applicable versions of the screen creation software.

### Compatibility when connecting FP0/FP2SH Series PLC

GOT-F900 Series	COM port		Connection type		OS version of GOT-F900	Version of screen creation software		
	RS-422	RS-232C	1:1	Two or more GOT units		GT Designer2	GT Designer	DU/WIN
F920GOT-K(5V)	–	–	–	–	–	–	–	–
F920GOT-K(24V)	–	✓	✓	–	1.20	SW1-C	–	–
F930GOT	–	✓	✓	–	4.10	SW1-C	SW5-K	2.60
F930GOT-K	–	✓	✓	–	4.60	SW1-C	SW5-26C	2.70
F940GOT	–	✓	✓	–	6.10	SW1-C	SW5-K	2.60
F940WGOT	–	✓	✓	–	1.10	SW1-C	SW5-K	2.60
F940 Handy GOT	–	–	It cannot be connected. (Select the F943 Handy GOT.)					
F943 Handy GOT	–	✓	✓	–	6.10	SW1-C	SW5-K	2.60

### Compatibility when connecting FPΣ Series PLC

Type	F920GOT-K	F930GOT	F930GOT-K	F940GOT	F940WGOT	Handy GOT
Applicable version of GOT-F900	1.20*2	4.62	4.62	6.62	1.62	6.62

- The screen creation software version corresponds to the model of the GOT-F900 Series. Refer to section 3.2.

\*1 Though RS-422 can be selected in the GOT-F900 and the screen creation software, FP Series products which can be connected to the GOT are not equipped with RS-422 interface.

\*2 Excluding the 5V type F920GOT-K.

### 18.1.1 Classification of Product Names

PLC CPU names are classified by the series as shown in the table below.

For the product model name and the built-in interface specifications corresponding to each series name mentioned here, refer to catalogs offered by Matsushita Electric Works.

Name	Series name	Built-in interface
Control unit	FP0 Series PLC FPΣ Series PLC	Tool port COM port (which is not built in some models)
CPU unit	FP2SH Series PLC	Tool port COM port
Computer communication unit	FP2SH Series CCU	COM port × 2 channels
Communication cassette	FPΣ Series FPG-COM	COM port × 1 channel or 2 channels



## 18.2 System Configuration

The FP Series PLC can be directly connected to the GOT RS-232C using a control unit, CPU unit or computer communication unit. This section explains the cables and options required in such a system.

### 18.2.1 Applicable model

The GOT-F900 can be connected to the following equipment in accordance with its OS version.

Operations are not assured when the GOT-F900 is connected to any other equipment.

For details of the OS version of the GOT-F900 and applicable equipment, refer to "3.1 OS Version and Correspondence to Connected Equipment of GOT-F900".

CPU	OPTION	COMMUNICATION PORT
FP0-T32CT	–	Connection to Tool port or COM port
FP2-C2	–	Connection to Tool port or COM port
	FP2-CCU	Connection to computer communication unit
FPG-C32T	–	Connection to Tool port
	FPG-COM1	Connection to computer communication unit
	FPG-COM2	

11

Connection of  
MELSEC-Q  
Series PLC

12

Connection of  
FX Series  
Positioning

13

Connection of  
FREQUOL  
Inverter

14

Connection of  
Microcom-  
puter

15

Connection of  
SYSMAC C  
Series PLC

16

Connection of  
FLEX-PC N  
Series PLC

17

Connection of  
Machine Con-  
troller

18

Connection of  
FP Series PLC

19

Connection of  
SLC500  
Series PLC

20

Connection of  
SIMATIC S7  
Series PLC

### 18.2.2 Configuration for CPU Direct Connection (RS-232C)

The FPΣ/FP0 Series control unit and the FP2SH Series CPU unit is equipped with built-in tool port and COM port (RS-232C interface). Only one GOT unit can be connected to an either interface.

#### 1) F920GOT-K (24V type)/F930GOT/F930GOT-K/F940GOT/F940WGOT

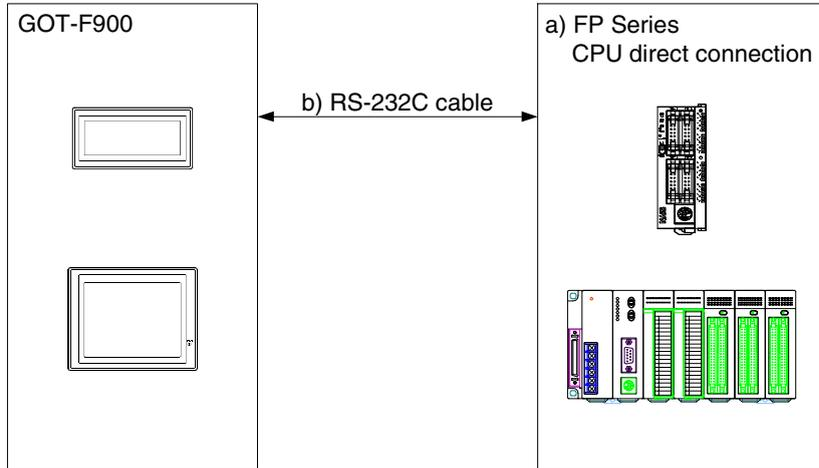

a) FP		b) RS-232C cable	Remarks
FP0 Series FP0-T32CT	5-pin MINI DIN	Prepared by the user (tool port)	Cable AFC8503S manufactured by Matsushita Electric Works is available.
	3-wire type	Prepared by the user (RS-232C COM port)	COM port may not be built in some models.
FP2SH Series FP2-C2	5-pin MINI DIN	Prepared by the user (tool port)	Cable AFC8503S manufactured by Matsushita Electric Works is available.
	3-wire type	Prepared by the user (RS-232C COM port)	
FP2SH Series FP2-C2+FP2-CCU	9-pin D-Sub	Prepared by the user (RS-232C COM port)	
FPΣ Series FPG-C32T	5-pin MINI DIN	Prepared by the user (tool port)	Cable AFC8503S manufactured by Matsushita Electric Works is available.
FPΣ Series FPG-C32T+FPG-COM1 FPG-C32T+FPG-COM2	3-wire type	Prepared by the user (RS-232C COM port)	

- Applicable FP Series products in the column a) are control units, CPU units and computer communication units equipped with built-in RS-232C interface.

2) F943 Handy GOT

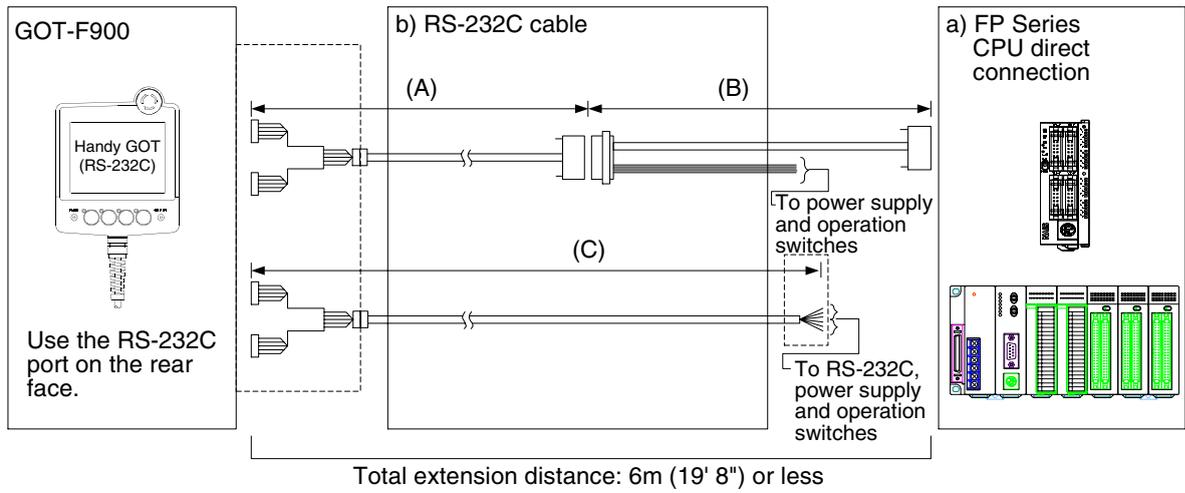

a) FP		b) RS-232C cable		Remarks
FP0 Series FP0-T32CT	5-pin MINI DIN	(A) F9GT-HCAB-3M (B) Prepared by the user (tool port) (C) F9GT-HCAB1-□□M		
	3-wire type	(A) F9GT-HCAB-3M (B) Prepared by the user (RS-232C COM port) (C) F9GT-HCAB1-□□M		COM port may not be built in some models.
FP2SH Series FP2-C2	5-pin MINI DIN	(A) F9GT-HCAB-3M (B) Prepared by the user (tool port) (C) F9GT-HCAB1-□□M		
	3-wire type	(A) F9GT-HCAB-3M (B) Prepared by the user (RS-232C COM port) (C) F9GT-HCAB1-□□M		
FP2SH Series FP2-C2+FP2-CCU	9-pin D-Sub	(A) F9GT-HCAB-3M (B) Prepared by the user (RS-232C COM port) (C) F9GT-HCAB1-□□M		
FPΣ Series FPG-C32T	5-pin MINI DIN	(A) F9GT-HCAB-3M (B) Prepared by the user (tool port) (C) F9GT-HCAB1-□□M		
FPΣ Series FPG-C32T+FPG-COM1 FPG-C32T+FPG-COM2	3-wire type	(A) F9GT-HCAB-3M (B) Prepared by the user (RS-232C COM port) (C) F9GT-HCAB1-□□M		

- Applicable FP Series products in the column a) are control units, CPU units and computer communication units equipped with built-in RS-232C interface.
- Make sure that the total cable extension distance "(A) + (B)" or (C) is 6m (19' 8") or less.

## 18.3 Setting of Series

When connecting the control unit or the CPU unit, the following setting should be executed using the Programming tool for the FP Series. When connecting the computer communication unit, the following setting should be executed using the DIP switches.

Further information for method of setting operation can be in relevant manual FP Series.

### 18.3.1 Communication Setting Specifications

This section explains the setting in the FP Series.

#### 1) Setting the transmission specifications

Set the transmission specifications as shown in the table below in the FP0/FPΣ Series control unit and the FP2SH Series CPU unit using the peripheral equipment for the FP Series or in the computer communication unit using the DIP switches.

For the DIP switch setting method, refer to the manual of the computer communication unit.

Item		CPU direct connection	Remarks
Transmission speed		19200bps	
Data format	Data length	7 bits	
	Parity check	Provided (even)	Fixed in the FP2-CCU
	Stop bit	1 bit	Fixed in the FP2-CCU
	Start code	STX not provided	Fixed in the FP2-CCU
	End code	CR	Fixed in the FP2-CCU

- The specifications such as the transmission speed are fixed on the GOT-F900 side, and cannot be changed.

#### 2) Setting the station number

Align the station number to the value (01 to 31) set in the GOT-F900.

If "00" is set in the GOT-F900, it is treated as "01".

The sample screens above are in Japanese.

### 18.3.2 Setting Examples in Computer Communication Unit

While referring to the setting examples shown below, set the transmission specifications using the DIP switches in the computer communication unit.

#### FP2-CCU

In the FP2-CCU, use the DIP switches for setting.

The settings of the communication speed and the data length of both the COM1 and the COM2 can be changed using the DIP switches provided on the rear face.

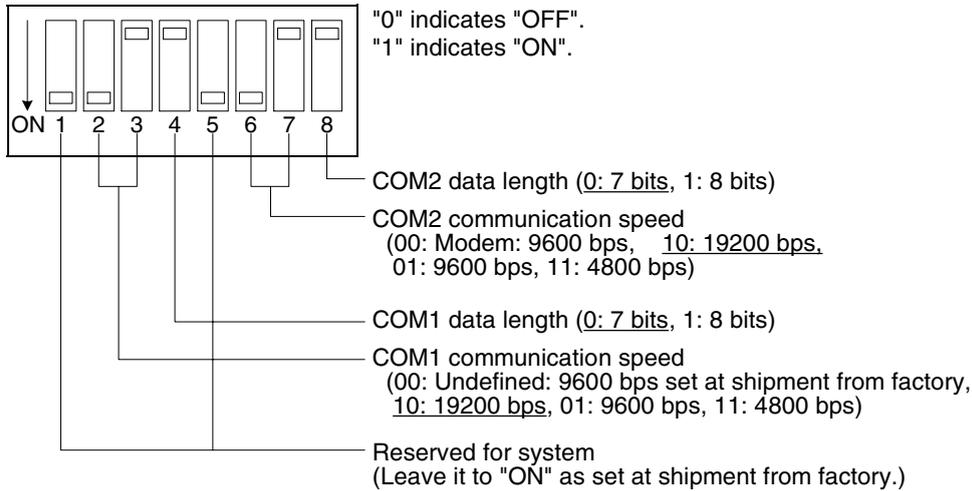

11

Connection of  
MELSEC-Q  
Series PLC

12

Connection of  
FX Series  
Positioning

13

Connection of  
FREQROL  
Inverter

14

Connection of  
Microcom-  
puter

15

Connection of  
SYSMAC C  
Series PLC

16

Connection of  
FLEX-PC N  
Series PLC

17

Connection of  
Machine Con-  
troller

18

Connection of  
FP Series PLC

19

Connection of  
SLC500  
Series PLC

20

Connection of  
SIMATIC S7  
Series PLC

## 18.4 Cautions on Use of FP Series

When using the GOT-F900 connected to the FP Series PLC, observe the following caution on use.

### 18.4.1 Device specification

Bit devices cannot be specified as word devices. Word devices cannot be specified as bit devices. (Pulse relays (P) and index registers (IX, IY, I) are not available.)

Only devices described in section 3.3 can be specified.

### 18.4.2 Devices which can be monitored

- Data register DT0 to DT16383 is available in the GOT-F900. Special data registers (DT9000 to DT9255) within this range can be monitored. In some FP Series models, however, DT9000 to DT9255 cannot be monitored. For the details, refer to the specifications described in the manual of the FP Series CPU.
- As to file registers, only the bank 0 can be monitored.
- Input relay (X), Error alarm relay (E), Timer contact (T) and Counter contact (C) cannot be written from the GOT-F900.

### 18.4.3 Cautions on connection of the control unit, the CPU unit and the computer communication unit

When connecting the control unit or the CPU unit

Connect the GOT-F900 to either one between the tool port and the COM port.

When connecting the computer communication unit or the communication cassette

Connect the GOT-F900 to either one between the COM1 port and the COM2 port.

Connection of two GOT units to one computer communication unit at the same time is not allowed.

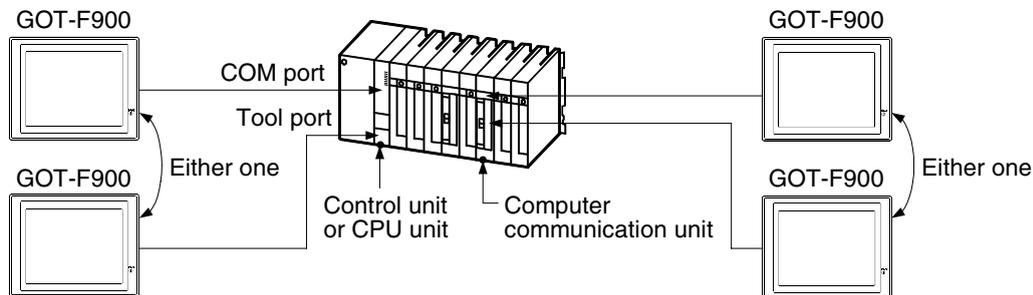

## 18.5 Setting of Connected Equipment for GOT

The setting for connection to the FP Series PLC can be executed using the GOT-F900 and the screen creation software (GT Designer2, GT Designer or DU/WIN).

### Setting the Connection Type

Set the connection type in accordance with the connected equipment as shown in the table below.

Connected equipment [classification in manual]	GOT-F900	DU/WIN	Remarks
	CONNECTION	Type	
Control unit	CPU direct connection (RS-232C)		FP0 Series
CPU unit			FP2SH Series, FPΣ Series
Computer communication unit			FP2-CCU
Communication cassette			FPΣ Series

#### 1) GOT-F900 Series

When the main menu screen change operation is disabled.

Operation	Display (screen name)
a) While pressing and holding the upper left corner of the screen, turn on the power. Keep holding the upper left corner for about 25 seconds more. Then, press "END" at the upper right corner.	The "LANGUAGE" screen appears.
b) Press "PLC TYPE".	The "SET-UP MODE" screen appears. The "PLC TYPE" screen appears.
c) Set the following. PLC TYPE: MEW FP SERIES CONNECTION: CPU PORT (RS-232C) DST STATION # (STATION #): 00 to 31 ("00" is treated as "01".) GOT STATION # (-) : -	

When the main menu screen change operation is enabled.

Operation	Display (screen name)
a) Press the upper left corner of the screen. (The position to be pressed can be changed in the GOT and the screen creation software.)	The "SELECT MODE" screen appears.
b) Press "OTHER MODE" on the menu.	The "OTHER MODE" screen appears.
c) Press "SET-UP MODE" on the menu.	The "SET-UP MODE" screen appears.
d) Press "PLC TYPE".	The "PLC TYPE" screen appears.
e) Set the following. PLC TYPE: MEW FP SERIES CONNECTION: CPU PORT (RS-232C) DST STATION # (STATION #): 00 to 31 ("00" is treated as "01".) GOT STATION # (-) : -	

- When the screen data is transferred to the GOT-F900, the old data including the PLC type, connection type, and station number are overwritten.

2) GT Designer2

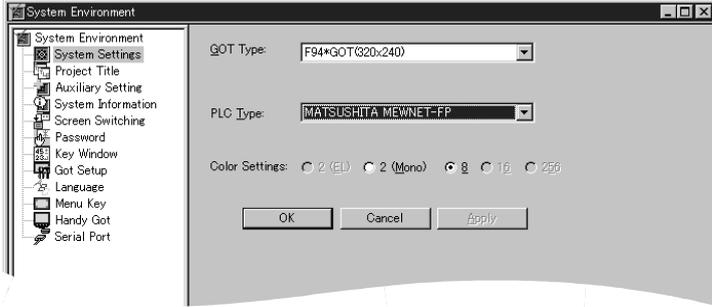
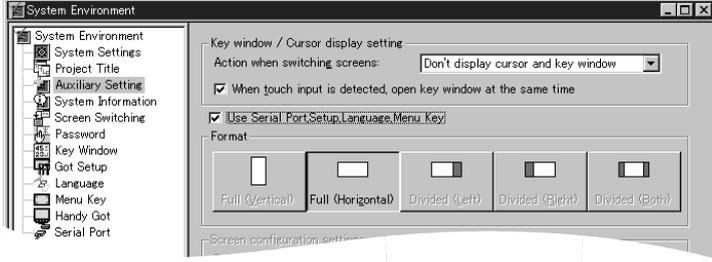
	Operation	Display (screen name)										
[Creation]	<p>a) Open GT Designer2.</p> <p>b) Click the [NEW] button. The dialog box shown below is displayed. If it is not displayed, click "System Environment" in the tree displayed in the project work space, then click "System settings" in the tree.</p>  <p>c) Set the following. GOT type: F940WGOT (480 × 234) F94*GOT (320 × 240) F93*GOT (240 × 80) F920GOT (128 × 64) PLC type: MATSUSHITA MEWNET-FP Selection of "GOT type"</p> <table border="1" data-bbox="483 1055 1114 1301"> <thead> <tr> <th>GOT type</th> <th>Model name (name)</th> </tr> </thead> <tbody> <tr> <td>F940WGOT(480×234)&lt;WIDE&gt;</td> <td>F940WGOT</td> </tr> <tr> <td>F94*GOT(320×240)</td> <td>F940GOT Handy GOT</td> </tr> <tr> <td>F93*GOT(240×80)</td> <td>F930GOT F930GOT-K</td> </tr> <tr> <td>F920GOT(128×64)</td> <td>F920GOT-K (24V)</td> </tr> </tbody> </table> <p>Click [OK].</p> <p>d) Setting the port (RS-232C) of the GOT-F900 Click "Auxiliary Setting" in the tree of the system environment menu. Click the check box of "Use Serial Port, Setup, Language, Menu Key" to give a check mark (✓).</p> 	GOT type	Model name (name)	F940WGOT(480×234)<WIDE>	F940WGOT	F94*GOT(320×240)	F940GOT Handy GOT	F93*GOT(240×80)	F930GOT F930GOT-K	F920GOT(128×64)	F920GOT-K (24V)	<p>The "Select Project" dialog box appears.</p> <p>The "System Environment" dialog box appears.</p> <p>The "Setting" dialog box appears.</p>
GOT type	Model name (name)											
F940WGOT(480×234)<WIDE>	F940WGOT											
F94*GOT(320×240)	F940GOT Handy GOT											
F93*GOT(240×80)	F930GOT F930GOT-K											
F920GOT(128×64)	F920GOT-K (24V)											

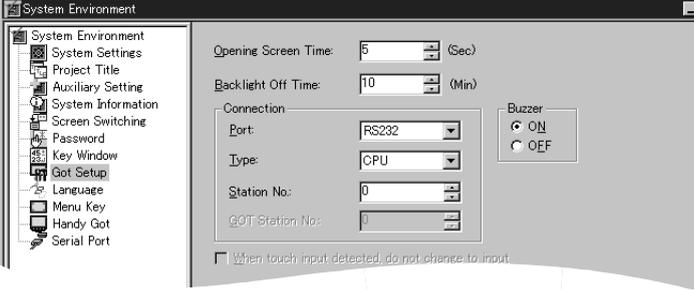

	Operation	Display (screen name)
	<p>Click "Got Setup" in the tree of the system environment menu.</p>  <p>e) Set the following.</p> <p>Port : RS-232C          Type : CPU          Station No. : 00 to 31 ("00" is treated as "01").          GOT Station No. : -</p> <p><u>In the case of F943 Handy GOT</u>          Without regard to the port setting (RS-422 or RS-232C), the COM0 side of the RS-232C is fixed for PLC connection.</p>	
[Change method]	<p>Change the connection type of the already created data as follows.</p> <p>a) Open GT Designer2.          b) Click the [Project]-[Open] button.          c) Open (read) the screen data to be changed.          d) On the menu, select "Common"- "System Environment".          - For the contents of setting, refer to c) of [Creation] above.          - For selection of the RS-232C on the FP Series PLCs, refer to e) of [Creation] above.</p>	<p>The "Select Project" dialog box appears.</p> <p>The "System Environment" dialog box appears.</p>

11

Connection of MELSEC-Q Series PLC

12

Connection of FX Series Positioning

13

Connection of FREQROL Inverter

14

Connection of Microcomputer

15

Connection of SYSMAC C Series PLC

16

Connection of FLEX-PC N Series PLC

17

Connection of Machine Controller

18

Connection of FP Series PLC

19

Connection of SLC500 Series PLC

20

Connection of SIMATIC S7 Series PLC



Operation		Display (screen name)
[Change method]	Change the connection type of the already created data as follows. a) Open GT Designer. b) Click the [Open] button. c) Open (read) the screen data to be changed. d) On the menu, select "Common"->"GOT/PLC Type". - For the contents of setting, refer to c) of [Creation] above. - For selection of the RS-232C on the FP Series PLCs, refer to e) of [Creation] above.	The "Select Project" dialog box appears.           The "GOT/PLC Type" dialog box appears.

11

Connection of MELSEC-Q Series PLC

12

Connection of FX Series Positioning

13

Connection of FREQROL Inverter

14

Connection of Microcomputer

15

Connection of SYSMAC C Series PLC

16

Connection of FLEX-PC N Series PLC

17

Connection of Machine Controller

18

Connection of FP Series PLC

19

Connection of SLC500 Series PLC

20

Connection of SIMATIC S7 Series PLC

4) DU/WIN

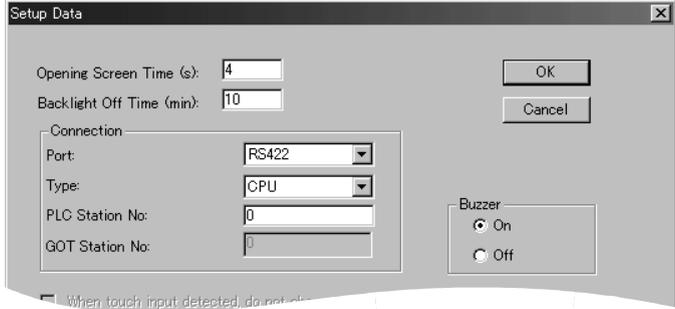
	Operation	Display (screen name)										
<p>[Creation]</p>	<p>a) Open the DU/WIN.</p> <p>b) On the menu, select "File"-"New".</p>  <p>c) Set the following.                      Terminal: F940WGOT-TWD (V)(H)                      F940GOT-LWD                      F940GOT-SWD                      F930GOT-BWD (V)(H)                      PLC System: Matsushita-FP</p> <p>Select "Terminal" in accordance with the LC display color.</p> <table border="1" data-bbox="464 864 1134 1155"> <thead> <tr> <th>Terminal</th> <th>Model name</th> </tr> </thead> <tbody> <tr> <td>F940WGOT-TWD (V)(H)</td> <td>F940WGOT (color)</td> </tr> <tr> <td>F940GOT-LWD</td> <td>F940GOT (black and white) Handy GOT (black and white)</td> </tr> <tr> <td>F940GOT-SWD</td> <td>F940GOT (color) Handy GOT (color)</td> </tr> <tr> <td>F930GOT-BWD (V)(H)</td> <td>F930GOT-K (blue) F930GOT (blue)</td> </tr> </tbody> </table> <p>d) Set CPU direct connection (RS-232C) of the GOT-F900.                      On the menu, select "View/Project"-"System Settings"-"Setup Data".</p>  <p>e) Set the following.                      Port: RS-232C                      Type: CPU                      DST Station No. (Station No.): 0 to 31                      GOT Station No. (-) : -</p>	Terminal	Model name	F940WGOT-TWD (V)(H)	F940WGOT (color)	F940GOT-LWD	F940GOT (black and white) Handy GOT (black and white)	F940GOT-SWD	F940GOT (color) Handy GOT (color)	F930GOT-BWD (V)(H)	F930GOT-K (blue) F930GOT (blue)	<p>The "Project settings" dialog box appears.</p> <p>The "Setup Data" dialog box appears.</p>
Terminal	Model name											
F940WGOT-TWD (V)(H)	F940WGOT (color)											
F940GOT-LWD	F940GOT (black and white) Handy GOT (black and white)											
F940GOT-SWD	F940GOT (color) Handy GOT (color)											
F930GOT-BWD (V)(H)	F930GOT-K (blue) F930GOT (blue)											
<p>[Change method]</p>	<p>Change the connection type of the already created data as follows.</p> <p>a) Open DU/WIN.</p> <p>b) On the menu, select "File"-"Open".</p> <p>c) Select and open (read) the file of the screen data to be changed.</p> <p>d) When changing "Terminal" (GOT-F900), select "View/Project"-"System Settings"-"Project settings" on the menu.                      - For the contents of setting, refer to c) of [Creation] above.                      - For selection of the RS-232C on the FP Series PLCs, refer to e) of [Creation] above.</p>	<p>The "Open" dialog box appears.</p> <p>The "Project settings" dialog box appears.</p>										

## 18.6 Cable Diagram

This section explains cable diagrams to connect the GOT-F900 and the FP Series PLC manufactured by Matsushita Electric Works controller.

### 18.6.1 Cautions on preparing cables

- When preparing the cables, use the wire size of 0.08mm<sup>2</sup> or more (AWG28 or more) for communication, 0.3mm<sup>2</sup> or more (AWG22 or more) for the power supply, operation switch, and emergency stop switch.
-  stands for a twisted pair cable. Prepare a twisted pair cable in combination of the pin numbers and signal lines described on the cable diagram. Do not use a twisted pair cable with the power supply wire and the communication wire.

### 18.6.2 Cable diagram

#### 1) Cable for the GOT and the FP Series PLC manufactured by Matsushita Electric Works

 : Female type  : Male type The connector figure shows the engagement face.

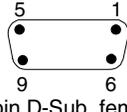
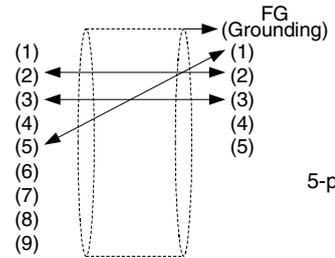
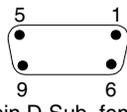
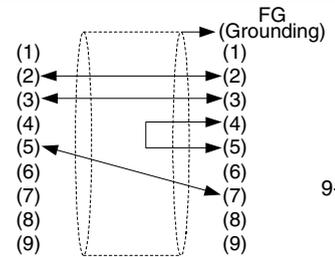
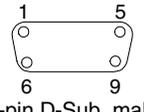
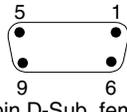
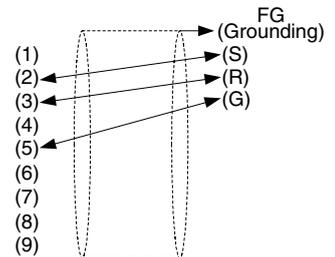
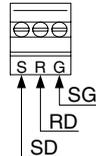
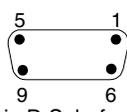
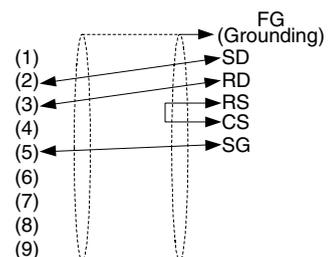
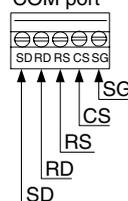
No.	Model name	Application	Connection diagram	Application
a)	<p>FP,FPΣ Series Prepared by the user (Cable AFC8503S manufactured by Matsushita Electric Works is available.)</p>	<p>To GOT-F900</p>  <p>9-pin D-Sub, female</p>	<p>RS-232C connection</p> 	<p>To tool port</p>  <p>5-pin MINI DIN, male</p>
b)	<p>FP Series Prepared by the user</p>	<p>To GOT-F900</p>  <p>9-pin D-Sub, female</p>	<p>RS-232C connection</p> 	<p>To COM port</p>  <p>9-pin D-Sub, male</p>
c)	<p>FP Series Prepared by the user</p>	<p>To GOT-F900</p>  <p>9-pin D-Sub, female</p>	<p>RS-232C connection</p> 	<p>To COM port</p>  <p>3-wire type</p>
d)	<p>FPΣ Series Prepared by the user</p>	<p>To GOT-F900</p>  <p>9-pin D-Sub, female</p>	<p>RS-232C connection</p> 	<p>To communication cassette FPG-COM1 COM port</p>  <p>3-wire type</p>

 : Female type  : Male type The connector figure shows the engagement face.

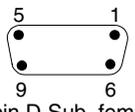
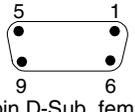
No.	Model name	Application	Connection diagram	Application
e)	<p style="text-align: center;"><b>RS-232C connection</b></p> <p><b>FPΣ Series</b> Prepared by the user (The GOT-F900 can be connected to either the port 1 or the port 2.)</p>	<p>To GOT-F900</p>  <p>9-pin D-Sub, female</p> <p>To GOT-F900</p>  <p>9-pin D-Sub, female</p>	<p>(1) → FG (Grounding)</p> <p>(2) → S1</p> <p>(3) → R1</p> <p>(4) → G</p> <p>(5) →</p> <p>(6) →</p> <p>(7) →</p> <p>(8) →</p> <p>(9) →</p> <p>(1) → FG (Grounding)</p> <p>(2) → S2</p> <p>(3) → R2</p> <p>(4) → G</p> <p>(5) →</p> <p>(6) →</p> <p>(7) →</p> <p>(8) →</p> <p>(9) →</p>	<p>To communication cassette FPG-COM2 COM port</p>  <p>S1 R1 S2 R2 SG</p> <p>3-wire type</p> <p>S1</p> <p>R1</p> <p>R2</p> <p>SG</p>

2) Cable for the F943 Handy GOT and the FP Series PLC manufactured by Matsushita Electric Works  
 When using the Handy GOT RH model, refer to the cable diagrams below for the RS-422/RS-232C connector, but not the wiring for the power supply, the operation switches, and the emergency stop switch because it is different. For details, refer to Section 5.18.

 : Female type  : Male type The connector figure shows the engagement face.

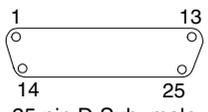
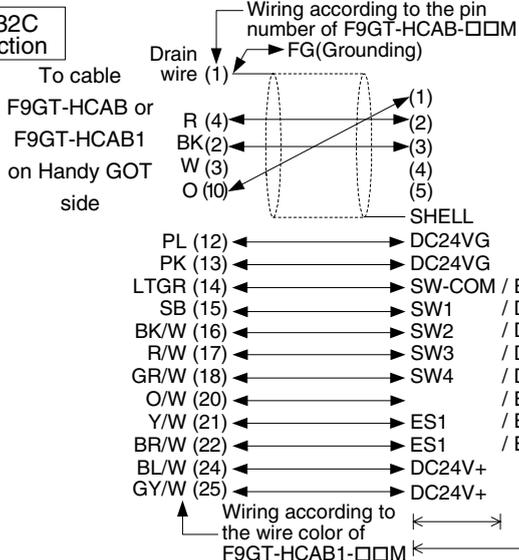
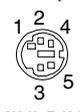
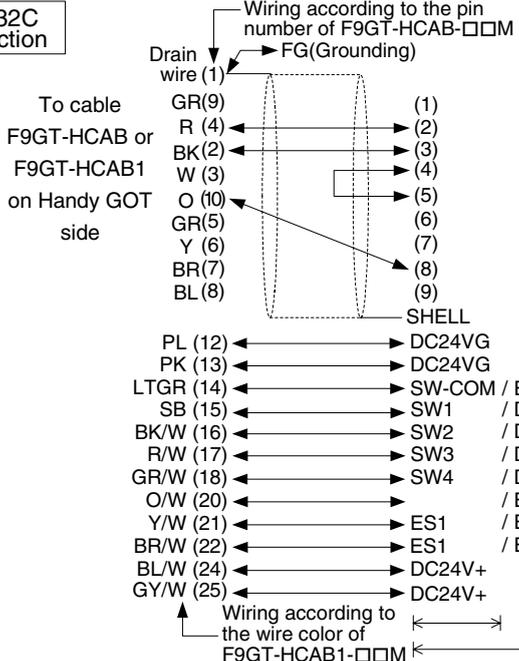
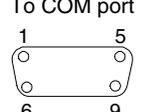
No.	Model name	Application	Connection diagram	Application
a)	F9GT-HCAB-3M F9GT-HCAB-10M	<div style="border: 1px solid black; padding: 2px; display: inline-block;">RS-422 connection</div> <div style="border: 1px solid black; padding: 2px; display: inline-block;">RS-232C connection</div> Dedicated connector on Handy GOT side	The connector on the leader side of the Handy GOT is dedicated, and cannot be prepared by the user.	To F9GT-HCAB3-150  25-pin D-Sub, male
b)	F9GT-HCAB1-3M F9GT-HCAB1-10M	<div style="border: 1px solid black; padding: 2px; display: inline-block;">RS-422 connection</div> <div style="border: 1px solid black; padding: 2px; display: inline-block;">RS-232C connection</div> Dedicated connector on Handy GOT side	The connector on the leader side of the Handy GOT is dedicated, and cannot be prepared by the user.	Loose wires (no connector)
c)	FP, FPΣ Series Prepared by the user	<div style="border: 1px solid black; padding: 2px; display: inline-block;">RS-232C connection</div> To cable F9GT-HCAB or F9GT-HCAB1 on Handy GOT side	 <p>Wiring according to the pin number of F9GT-HCAB-□□M</p> <p>Drain wire (1) → FG (Grounding)</p> <p>PL (12) ←→ DC24VG                      PK (13) ←→ DC24VG                      LTGR (14) ←→ SW-COM / ES1-2                      SB (15) ←→ SW1 / DSW2                      BK/W (16) ←→ SW2 / DSW2                      R/W (17) ←→ SW3 / DSW1                      GR/W (18) ←→ SW4 / DSW1                      O/W (20) ←→ / ES1-2                      Y/W (21) ←→ ES1 / ES1-1                      BR/W (22) ←→ ES1 / ES1-1                      BL/W (24) ←→ DC24V+                      GY/W (25) ←→ DC24V+</p> <p>Wiring according to the wire color of F9GT-HCAB1-□□M</p>	To tool port  5-pin MINI-DIN, male Wire the power supply, the operation switches and the emergency stop switch. Old cable description ←→ New cable description
d)	FP Series Prepared by the user	<div style="border: 1px solid black; padding: 2px; display: inline-block;">RS-232C connection</div> To cable F9GT-HCAB or F9GT-HCAB1 on Handy GOT side	 <p>Wiring according to the pin number of F9GT-HCAB-□□M</p> <p>Drain wire (1) → FG (Grounding)</p> <p>GR(9) → (1)                      R (4) → (2)                      BK(2) → (3)                      W (3) → (4)                      O (10) → (5)                      GR(5) → (6)                      Y (6) → (7)                      BR(7) → (8)                      BL (8) → (9)</p> <p>PL (12) ←→ DC24VG                      PK (13) ←→ DC24VG                      LTGR (14) ←→ SW-COM / ES1-2                      SB (15) ←→ SW1 / DSW2                      BK/W (16) ←→ SW2 / DSW2                      R/W (17) ←→ SW3 / DSW1                      GR/W (18) ←→ SW4 / DSW1                      O/W (20) ←→ / ES1-2                      Y/W (21) ←→ ES1 / ES1-1                      BR/W (22) ←→ ES1 / ES1-1                      BL/W (24) ←→ DC24V+                      GY/W (25) ←→ DC24V+</p> <p>Wiring according to the wire color of F9GT-HCAB1-□□M</p>	To COM port  9-pin D-Sub, male Wire the power supply, the operation switches and the emergency stop switch. Old cable description ←→ New cable description

11 Connection of MELSEC-Q Series PLC  
 12 Connection of FX Series Positioning  
 13 Connection of FREQROL Inverter  
 14 Connection of Microcomputer  
 15 Connection of SYSMAC C Series PLC  
 16 Connection of FLEX-PC N Series PLC  
 17 Connection of Machine Controller  
 18 Connection of FP Series PLC  
 19 Connection of SLC500 Series PLC  
 20 Connection of SIMATIC S7 Series PLC

: Female type : Male type The connector figure shows the engagement face.

No.	Model name	Application	Connection diagram	Application
e)	FP Series Prepared by the user	RS-232C connection To cable F9GT-HCAB or F9GT-HCAB1 on Handy GOT side	<p>Wiring according to the pin number of F9GT-HCAB-□□M</p> <p>Wiring according to the wire color of F9GT-HCAB1-□□M</p>	<p>To COM port</p> <p>3-wire type</p> <p>Wire the power supply, the operation switches and the emergency stop switch.</p> <p>Old cable description New cable description</p>
f)	FPΣ Series Prepared by the user	RS-232C connection To cable F9GT-HCAB or F9GT-HCAB1 on Handy GOT side	<p>Wiring according to the pin number of F9GT-HCAB-□□M</p> <p>Wiring according to the wire color of F9GT-HCAB1-□□M</p>	<p>To communication cassette FPG-COM1 COM port</p> <p>3-wire type</p> <p>Wire the power supply, the operation switches and the emergency stop switch.</p> <p>Old cable description New cable description</p>



: Female type : Male type The connector figure shows the engagement face.

No.	Model name	Application	Connection diagram	Application
g)	<p><b>RS-232C connection</b></p> <p><b>FPΣ Series</b> Prepared by the user (The GOT-F900 can be connected to either the port 1 or the port 2.)</p>	<p>To cable F9GT-HCAB or F9GT-HCAB1 on Handy GOT side</p>	<p>Wiring according to the pin number of F9GT-HCAB-□□M</p> <p>Drain wire (1) → FG (Grounding)</p> <p>R (4) → S1 BK (2) → R1 W (3) → G</p> <p>O (10)</p> <p>BR (5) Y (6) BR (7) BL (8) GR (9)</p> <p>Wiring according to the pin number of F9GT-HCAB-□□M</p> <p>Drain wire (1) → FG (Grounding)</p> <p>R (4) → S2 BK (2) → R2 W (3) → G</p> <p>O (10)</p> <p>BR (5) Y (6) BR (7) BL (8) GR (9)</p> <p>PL (12) → DC24VG PK (13) → DC24VG LTGR (14) → SW-COM / ES1-2 SB (15) → SW1 / DSW2 BK/W (16) → SW2 / DSW2 R/W (17) → SW3 / DSW1 GR/W (18) → SW4 / DSW1 O/W (20) → ES1 / ES1-2 Y/W (21) → ES1 / ES1-1 BR/W (22) → ES1 / ES1-1 BL/W (24) → DC24V+ GY/W (25) → DC24V+</p> <p>Wiring according to the wire color of F9GT-HCAB1-□□M</p>	<p>To communication cassette FPG-COM2 COM port</p> <p>3-wire type</p> <p>SG R2 S2 R1 S1</p> <p>Wire the power supply, the operation switches and the emergency stop switch.</p> <p>Old cable description New cable description</p>

11	Connection of MELSEC-Q Series PLC
12	Connection of FX Series Positioning
13	Connection of FREQROL Inverter
14	Connection of Microcomputer
15	Connection of SYSMAC C Series PLC
16	Connection of FLEX-PC N Series PLC
17	Connection of Machine Controller
18	Connection of FP Series PLC
19	Connection of SLC500 Series PLC
20	Connection of SIMATIC S7 Series PLC

## 18.7 Troubleshooting

For reference, this section summarizes frequently asked questions about connection of the GOT-F900 to the FP Series PLC manufactured by Matsushita Electric Works.

### 1) GOT-F900

Contents of trouble	Check points and countermeasures	OS version		
		F940W	F940	F930
"COMMUNICATION ERROR OCCURS" is displayed when a screen changeover or numeric data input is performed on the GOT-F900 screen.	<p>The power of the FP Series PLC is turned off.</p> <ul style="list-style-type: none"> <li>• Cause Communication is disabled because the power of the FP Series PLC is turned off.</li> <li>• Countermeasures Turn on the power.</li> </ul>	From first product	From first product	From first product
	<p>Something is wrong with the cable between the GOT-F900 and the FP Series PLC.</p> <ul style="list-style-type: none"> <li>• Causes The wrong cable is used or the connection is bad.</li> <li>• Countermeasures Check the cable.</li> </ul>			
"DISPLAY SCREEN IS NOT AVAILABLE." is displayed on the GOT-F900 screen.	<p>Canaveral to a nonexistent screen by a touch key or the FP Series PLC was tried.</p> <ul style="list-style-type: none"> <li>• Cause The changeover destination screen has not been created yet.</li> <li>• Countermeasures Create the screen.</li> </ul>	–	Earlier than 6.00	Earlier than 4.00
"DISPLAY SCREEN IS NOT AVAILABLE. (NO. ####)" is displayed on the GOT-F900 screen.	<p>A nonexistent screen was tried to be displayed.</p> <ul style="list-style-type: none"> <li>• Cause The screen No. #### has not been created yet.</li> <li>• Countermeasures Create the screen.</li> </ul>	From first product	6.00 or later	4.00 or later
"DISPLAY SCREEN IS NOT AVAILABLE." is displayed on the GOT-F900 screen.	<p>A device that does not exist in the FP Series PLC was referenced. (Example: While an FP0 is connected, a device exists only in the FP2SH is specified for numeric input.)</p> <ul style="list-style-type: none"> <li>• Cause On the changeover destination screen (excluding the head screen), a nonexistent device in the connected FP Series PLC is specified.</li> <li>• Countermeasures Check the devices used on the head screen.</li> </ul>	–	Earlier than 6.00	Earlier than 4.00
	<p>There is an error on the screen to be displayed.</p> <ul style="list-style-type: none"> <li>• Cause One of the screen objects is placed outside the available screen area.</li> <li>• Countermeasures Check the placement of screen objects.</li> </ul>			

Contents of trouble	Check points and countermeasures	OS version		
		F940W	F940	F930
"DISPLAY SCREEN IS NOT AVAILABLE. (NO. ####)" is displayed on the GOT-F900 screen.	<p>The display screen contains an error.</p> <ul style="list-style-type: none"> <li>Causes A device that does not exist in the connected PLC is referenced on the screen No. ####, or one of the screen objects is placed outside the available screen area.</li> <li>Countermeasures Check the devices used and placement of screen objects.</li> </ul>	From first product	6.00 or later	4.00 or later
"DATA IS NOT FOUND." is displayed on the GOT-F900 screen.	<p>There is not data because the unit is new or the memory clear has been executed.</p> <ul style="list-style-type: none"> <li>Cause There is no screen data.</li> <li>Countermeasures Write the screen data using the screen creation software.</li> </ul>	-	Earlier than 6.00	Earlier than 4.00
	<p>A device that does not exist in the FP Series PLC is referenced. (Example: While an FP0 is connected, a device exists only in the FP2SH is specified for numeric input.)</p> <ul style="list-style-type: none"> <li>Cause On the head screen, a nonexistent device in the connected FP Series PLC is specified. (The head screen is the screen No. 1 in the GT Designer, and the screen No. 0 in the DU/WIN.)</li> <li>Countermeasures Check the devices used on the head screen.</li> </ul>			
	<p>There is not data because the unit is new or the memory clear has been executed.</p> <ul style="list-style-type: none"> <li>Cause There is no screen data.</li> <li>Countermeasures Write the screen data using the screen creation software.</li> </ul>			
"CAN NOT WRITE TO PLC MEMORY." is displayed on the GOT-F900 screen.	This error is not displayed.	Earlier than 1.10	Earlier than 6.10	Earlier than 4.10
"CAN NOT WRITE." is displayed on the GOT-F900 screen.	This error is not displayed.	1.10 or later	6.10 or later	4.10 or later
"CAN NOT USE THE FUNCTION WHILE PROTECTED." is displayed on the GOT-F900 screen.	This error is not displayed.	From first product	From first product	From first product
"PLC IS RUNNING." is displayed on the GOT-F900 screen.	This error is not displayed.	From first product	From first product	From first product

11	Connection of MELSEC-Q Series PLC
12	Connection of FX Series Positioning
13	Connection of FREQROL Inverter
14	Connection of Microcomputer
15	Connection of SYSMAC C Series PLC
16	Connection of FLEX-PC N Series PLC
17	Connection of Machine Controller
18	Connection of FP Series PLC
19	Connection of SLC500 Series PLC
20	Connection of SIMATIC S7 Series PLC

## 2) Software

	Contents of trouble	Check points and countermeasures
Screen creation software	Communication with the screen creation software and screen data cannot be transferred.	<p>An FP Series PLC, bar code reader or printer is connected.</p> <ul style="list-style-type: none"> <li>• Causes The RS-232C connector to which the personal computer is connected is set to be used for another piece of equipment.</li> <li>• Countermeasures In the GOT-F900, select by hand "SELECT MODE"-"OTHER MODE"-"DATA TRANSFER". Or set a bar code reader to invalid and a printer to "DON'T USE".</li> </ul> <p>Something is wrong with the cable between the GOT-F900 and the personal computer.</p> <ul style="list-style-type: none"> <li>• Causes The connected cable is not proper. Or cable connection is not correct.</li> <li>• Countermeasures Check the cable.</li> </ul>

## 19. Connection of SLC500/MicroLogix Series PLC (Manufactured by Allen-Bradley)

This chapter explains the procedure to connect the GOT-F900 Series display unit to the SLC500/MicroLogix Series PLC.

### Connection Procedure

This section introduces the procedure to connect the GOT-F900 to the SLC500/MicroLogix Series PLC.

#### 1. Preparation

Item name	Description	Reference
System Condition	You can learn the connection availability as well as the version of the GOT-F900 OS and the screen creation software.	19.1
System Configuration	You can select the configuration between the GOT and the SLC500/MicroLogix Series PLC and proper cables.	19.2

#### 2. Setting

Item name	Description	Reference		
Setting in SLC500	You can learn the communication specifications and the contents of setting.		19.3	
	Communication Setting Specifications	The the transmission specifications set in the SLC500 CPU		19.3.1
	GOT-F900 Transmission Specifications	The communication specifications set in the GOT		19.3.2
	Example of Setting Screen of RSLogix500 Software	The setting screen of the package software RSLogix500		19.3.3
Setting in MicroLogix	You can learn the communication specifications and the contents of setting.		19.4	
	Communication Setting Specifications	The transmission specifications set in the MicroLogix CPU		19.4.1
	GOT-F900 Transmission Specifications	The communication specifications set in the GOT		19.4.2
	Example of Setting Screen of RSLogix500 Software	The setting screen of the package software RSLogix500		19.4.3
Device Specification Method	You can learn devices which can be monitored in the GOT and their formats.		19.5	
	Device Format	How to see devices		19.5.1
	File Number and Element Range	The file number and allowable element specification range		19.5.2
	Restriction in Device Specification	Cautions on unsupported devices		19.5.3
Caution on Use of SLC500/MicroLogix Series PLC	You can learn the restrictions in connecting the GOT to the SLC500/MicroLogix Series PLC.	19.6		
Setting of Connected Equipment for GOT	Set the PLC type using the GOT or the screen creation software.	19.7		

### 3. Others

Item name	Description	Reference
Cable Diagram	Cable diagrams for SLC500/MicroLogix Series PLC and GOT connection	19.8
Troubleshooting	Description of errors and how to fix them	19.9

## 19.1 System Condition

When connecting the SLC500/MicroLogix Series PLC, check the COM port designation, the OS version of the GOT-F900, and applicable versions of the screen creation software.

Compatibility when connecting SLC500 Series PLC

GOT-F900 Series	COM port		Connection type		OS version of GOT-F900	Version of screen creation software		
	RS-422	RS-232C	1:1	Two or more GOT units		GT Designer2	GT Designer	DU/WIN
F920GOT-K(5V)	–	–	–	–	–	–	–	–
F920GOT-K(24V)	–	✓	✓	–	1.20	SW1-C	–	–
F930GOT	–	✓	✓	–	2.00	SW1-C	SW1-H	2.30
F930GOT-K	–	✓	✓	–	4.60	SW1-C	SW5-26C	2.70
F940GOT	–	✓	✓	–	2.00	SW1-C	SW1-A	2.30
F940WGOT	–	✓	✓	–	1.00	SW1-C	SW5-F	2.50
F940 Handy GOT	–	–	It cannot be connected. Select the F943 Handy GOT.					
F943 Handy GOT	–	✓	✓	–	2.00	SW1-C	SW1-D	2.30

Compatibility when connecting MicroLogix Series PLC

Type	F920GOT-K	F930GOT	F930GOT-K	F940GOT	F940WGOT	Handy GOT
GOT-F900 OS version	1.20 <sup>*1</sup>	4.00	4.60	6.00	1.00	6.00

- The screen creation software (GT Designer) Version SW5-F (5.05F) or later which is applicable to the MicroLogix Series is required.  
Screens cannot be created using a version earlier than SW5-F (5.05F). Prepare an applicable version.
- The screen creation software (DU/WIN) version 2.50 or later which is applicable to the MicroLogix Series is required.  
Screens cannot be created using a version earlier than 2.50. Prepare an applicable version.

\*1 Excluding the 5V type F920GOT-K.

## 19.2 System Configuration

The SLC500/MicroLogix Series PLC can be directly connected to the GOT via RS-232C. This section explains the cables and options required in such a system.

### 19.2.1 Applicable model

The GOT-F900 can be connected to the following equipment in accordance with its OS version. Operations are not assured when the GOT-F900 is connected to any other equipment. For details of the OS version of the GOT-F900 and applicable equipment, refer to "3.1 OS Version and Correspondence to Connected Equipment of GOT-F900".

CPU	OPTION	COMMUNICATION PORT
SLC5/03	-	Connection to Built-in port
SLC5/04		
MicroLogix1000*1		
MicroLogix1000 Analog		
MicroLogix1200		
MicroLogix1500		

\*1 Only the Series D or later can be connected.

### 19.2.2 Configuration for CPU Direct Connection (RS-232C)

The GOT-F900 and the SLC500/MicroLogix Series CPU can be connected on the 1:1 basis. For the cable length or the detailed specifications of the SLC500/MicroLogix Series, refer to the corresponding manual.

#### 1) F920GOT-K (24V type)/F930GOT/F930GOT-K/F940GOT/F940WGOT

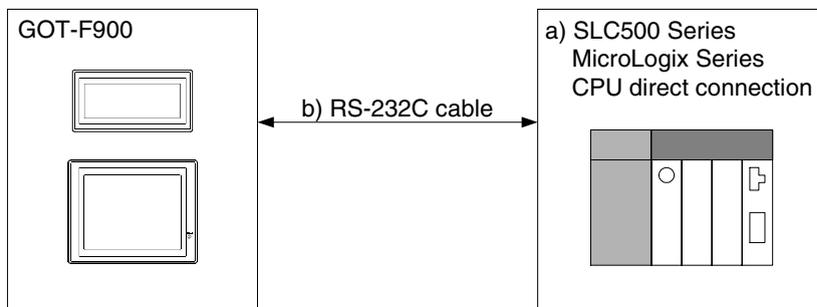

a) SLC500, MicroLogix		b) RS-232C cable	Remarks
SLC5/03	9-pin D-Sub, male	Prepared by the user	
SLC5/04			
MicroLogix1000*1	8-pin MINI DIN, female	Prepared by the user *2	
MicroLogix1000 Analog			
MicroLogix1200			
MicroLogix1500			

\*1 Only the Series D or later can be connected.

\*2 1761-CBL-PM02 cable (Series C or later) manufactured by Allen-Bradley is available.

2) F943 Handy GOT

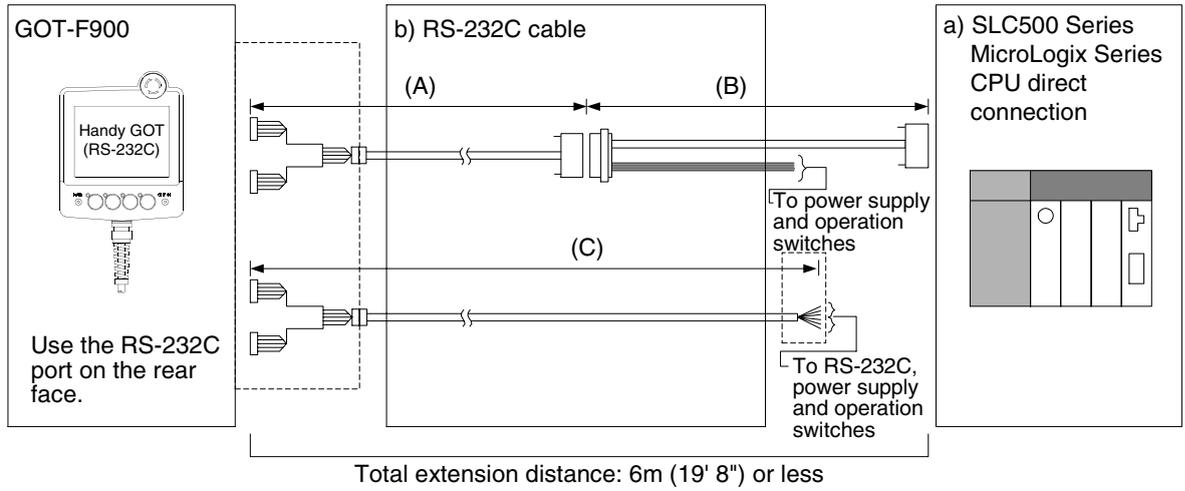

a) SLC500, MicroLogix		b) RS-232C cable	Remarks
SLC5/03	9-pin D-Sub, female	(A) F9GT-HCAB-3M	
SLC5/04		(B) Prepared by the user	
		(C) F9GT-HCAB1-□□M	
MicroLogix1000*1	8-pin MINI DIN, male	(A) F9GT-HCAB-3M	
MicroLogix1000 Analog		(B) Prepared by the user	
MicroLogix1200		(C) F9GT-HCAB1-□□M	
MicroLogix1500			

\*1 Only the Series D or later can be connected.

- Make sure that the total cable extension distance "(A) + (B)" or (C) is 6m (19' 8") or less.



## 19.3 Setting in SLC500

When directly connecting the SLC500 CPU, the usage of the RS-232C port should be changed using the peripheral equipment for the SLC500 Series (package software RSLogix500).

### 19.3.1 Communication Setting Specifications

Set the transmission specifications in the SLC500 as shown in the table below. For the setting method, refer to the manual of the SLC500 Series.

#### Setting the RS-232C (channel 0) Parameters

Parameter	Set value
System Mode Driver	DF1 Half-Duplex Slave
Others	Leave them in default values.

#### DF1 Half-Duplex Slave Channel Configuration

Set the parameters in shaded boxes. Leave other parameters in default values.

Parameter	Set value
Diagnostic File	–
Baud Rate	19200 bps
Parity	Even
Duplicate Packet Delection	Disabled
Node Address	0 to 31 (Align with the station number setting in the GOT.)
Error Delection	BCC
Poll Timeout	50
RTS Off Delay	0
RTS Send Delay	0
Message Retries	3
Control Line	No Handshanking
EOT Suppression	No

### 19.3.2 GOT-F900 Transmission Specifications

Item	Set value	
Transmission speed	19200 bps	
Data format	Data bit	8 bits
	Parity bit	Provided (even)
	Stop bit	1 bit
	Control method	Not provided

- The specifications such as the transmission speed are fixed on the GOT-F900 side, and cannot be changed.

11

Connection of  
MELSEC-Q  
Series PLC

12

Connection of  
FX Series  
Positioning

13

Connection of  
FREQROL  
Inverter

14

Connection of  
Microcom-  
puter

15

Connection of  
SYSMAC C  
Series PLC

16

Connection of  
FLEX-PC N  
Series PLC

17

Connection of  
Machine Con-  
troller

18

Connection of  
FP Series PLC

19

Connection of  
SLC500  
Series PLC

20

Connection of  
SIMATIC S7  
Series PLC

## 19.4 Setting in MicroLogix

When directly connecting the MicroLogix CPU, the usage of the RS-232C port should be changed using the peripheral equipment for the PLC (package software RSLogix500).

### 19.4.1 Communication Setting Specifications

Set the transmission specifications in the MicroLogix as shown in the table below. For the setting method, refer to the manual of the MicroLogix Series.

#### Setting the RS-232C (channel 0) Parameters

Parameter	Set value
System Mode Driver	DF1 Half-Duplex Slave
Others	Leave them in default values.

#### DF1 Half-Duplex Slave Channel Configuration

Set the parameters in shaded boxes. Leave other parameters in default values.

Parameter	Set value
Node Address	0 to 31 (Align with the station number setting in the GOT)
Baud Rate	9600 bps
Parity	None
Duplicate Packet Delection	Enable
Error Delection	CRC
Poll Timeout	3000
RTS Off Delay	0
RTS Send Delay	0
Message Retries	3
Control Line	No Handshanking
EOT Suppression	No

### 19.4.2 GOT-F900 Transmission Specifications

Item	Set value	
Transmission speed	9600 bps	
Data format	Data bit	8 bits
	Parity bit	Not provided
	Stop bit	1 bit
	Control method	Not provided

- The specifications such as the transmission speed are fixed on the GOT-F900 side, and cannot be changed.





## 19.5.2 File Number and Element Range

This section explains file numbers and element range of devices which can be monitored in the GOT-F900.

### 1) SLC500 Series

Device name (symbol)		Conventional format	New format	File number *1	Available element specification range
Bit device	Bit	(B)	(B)	3 10 to 255	0 to 255 <sup>*2</sup>
	Timer (timing bit)	(TT)	(T)	4 10 to 255	0 to 255
	Timer (completion bit)	(TN)	(T)	4 10 to 255	0 to 255
	Counter (up counter)	(CU)	(C)	5 10 to 255	0 to 255
	Counter (down counter)	(CD)	(C)	5 10 to 255	0 to 255
	Counter (completion bit)	(CN)	(C)	5 10 to 255	0 to 255
Word device	Timer (set value)	(TP)	(T)	4 10 to 255	0 to 255
	Timer (current value)	(TA)	(T)	4 10 to 255	0 to 255
	Counter (set value)	(CP)	(C)	5 10 to 255	0 to 255
	Counter (current value)	(CA)	(C)	5 10 to 255	0 to 255
	Integer	(N)	(N)	7 10 to 255	0 to 255

\*1 The file number 10 to 255 are available in the user settings.

\*2 The bit position can be specified in the range from 0 to F (15) for each element.

### 2) MicroLogix1000/1200/1500 Series

Device name (symbol)		File number *1	Available element specification range
Bit device	Bit	(B)	3 to 255
	Timer (timing bit)	(T)	3 to 255
	Timer (completion bit)	(T)	3 to 255
	Counter (up counter)	(C)	3 to 255
	Counter (down counter)	(C)	3 to 255
	Counter (completion bit)	(C)	3 to 255
Word device	Timer (set value)	(T)	3 to 255
	Timer (current value)	(T)	3 to 255
	Counter (set value)	(C)	3 to 255
	Counter (current value)	(C)	3 to 255
	Integer	(N)	3 to 255

\*1 The file numbers 3 to 255 are available in the user settings.

\*2 The bit position can be specified in the range from 0 to 15 for each element.

## 19.5.3 Restriction in Device Specification

- Word specification of bit devices and bit specification of word devices are not enabled in the GOT.
- Devices not shown in the tables above (devices related to input image, output image, status, control, floating point and network) are not available in the GOT.

## **19.6 Caution on Use of SLC500/MicroLogix Series PLC**

When using the GOT-F900 connected to the SLC500/Micro Logix Series PLC, observe the following caution on use.

### **19.6.1 Device setting in advance**

The user is required to set devices to be used for the SLC500/MicroLogix Series. Accordingly, if devices to be monitored or set are not specified in the PLC, a communication error occurs.

### **19.6.2 Caution on use of the sampling function**

The GOT-F900 is always monitoring sampling devices in the sampling mode even if the sampling condition is not set. As a result, a communication error occurs if sampling devices are not present. In such a case, change sampling devices or set devices in the SLC500/MicroLogix Series.

## 19.7 Setting of Connected Equipment for GOT

The setting for connection to the SLC500/MicroLogix Series PLC can be executed using the GOT-F900 and the screen creation software (GT Designer2, GT Designer or DU/WIN).

### 1) GOT-F900 Series

When the main menu screen change operation is disabled.

Operation	Display (screen name)
a) While pressing and holding the upper left corner of the screen, turn on the power. Keep holding the upper left corner for about 25 seconds more. Then, press "END" at the upper right corner.	The "LANGUAGE" screen appears.
b) Press "PLC TYPE".	The "SET-UP MODE" screen appears.
c) Set the following. PLC TYPE: AB SLC500 AB Micrologix CONNECTION: CPU PORT (RS-232C) DST STATION # (STATION #) : 00 to 31 GOT STATION # (-) : -	The "PLC TYPE" screen appears.

When the main menu screen change operation is enabled.

Operation	Display (screen name)
a) Press the upper left corner of the screen. (The position to be pressed can be changed in the GOT and the screen creation software.)	The "SELECT MODE" screen appears.
b) Press "OTHER MODE" on the menu.	The "OTHER MODE" screen appears.
c) Press "SET-UP MODE" on the menu.	The "SET-UP MODE" screen appears.
d) Press "PLC TYPE".	The "PLC TYPE" screen appears.
e) Set the following. PLC TYPE: AB SLC500 AB Micrologix CONNECTION: CPU PORT (RS-232C) DST STATION # (STATION #) : 00 to 31 GOT STATION # (-) : -	

- When the screen data is transferred to the GOT-F900, the old data including the PLC type, connection type, and station number are overwritten.
- The "PLC type" selection item display varies depending on the OS version.

"PLC TYPE" selection item display		AB SLC500	AB SLC500*1 AB MicroLogix
Version	F940WGOT	-	1.00 or later
	F940GOT, Handy GOT	2.00 or later	6.00 or later
	F930GOT	2.00 or later	6.00 or later
	F930GOT-K	4.60 or later	4.60 or later
	F920GOT-K (24V)	1.20 or later	1.20 or later

\*1 The selection item display is changed to "AB SLC500" and "AB MicroLogix".

2) GT Designer2

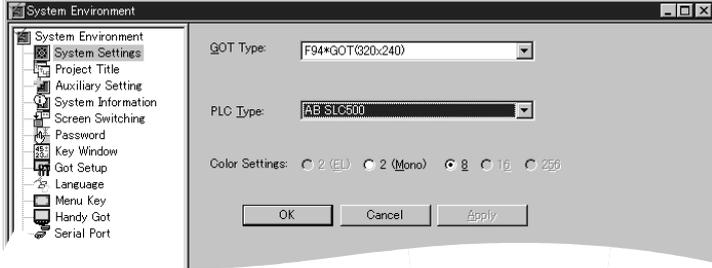
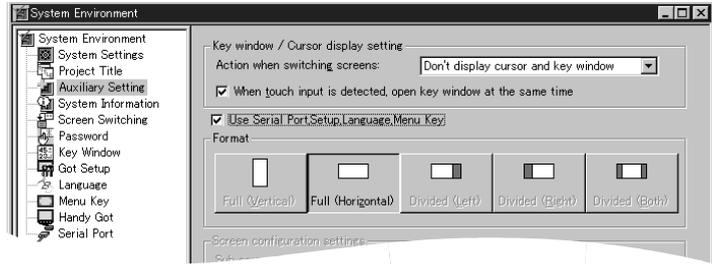
	Operation	Display (screen name)										
[Creation]	<p>a) Open GT Designer2.</p> <p>b) Click the [NEW] button. The dialog box shown below is displayed. If it is not displayed, click "System Environment" in the tree displayed in the project work space, then click "System settings" in the tree.</p>  <p>c) Set the following. GOT type: F940WGOT (480 × 234) F94*GOT (320 × 240) F93*GOT (240 × 80) F920GOT (128 × 64) PLC type: AB SLC500 AB MicroLogix1000/1200/1500 Selection of "GOT type"</p> <table border="1" data-bbox="483 1048 1114 1294"> <thead> <tr> <th>GOT type</th> <th>Model name (name)</th> </tr> </thead> <tbody> <tr> <td>F940WGOT(480×234)&lt;WIDE&gt;</td> <td>F940WGOT</td> </tr> <tr> <td>F94*GOT(320×240)</td> <td>F940GOT Handy GOT</td> </tr> <tr> <td>F930GOT(240×80)</td> <td>F930GOT F930GOT-K</td> </tr> <tr> <td>F920GOT (128 × 64)</td> <td>F920GOT-K (24V)</td> </tr> </tbody> </table> <p>Click [OK].</p> <p>d) Setting the port (RS-422 or RS-232C) of the GOT-F900 Click "Auxiliary Setting" in the tree of the system environment menu. Click the check box of "Use Serial Port, Setup, Language, Menu Key" to give a check mark (✓).</p> 	GOT type	Model name (name)	F940WGOT(480×234)<WIDE>	F940WGOT	F94*GOT(320×240)	F940GOT Handy GOT	F930GOT(240×80)	F930GOT F930GOT-K	F920GOT (128 × 64)	F920GOT-K (24V)	<p>The "Select Project" dialog box appears.</p> <p>The "System Environment" dialog box appears.</p> <p>The "Setting" dialog box appears.</p>
GOT type	Model name (name)											
F940WGOT(480×234)<WIDE>	F940WGOT											
F94*GOT(320×240)	F940GOT Handy GOT											
F930GOT(240×80)	F930GOT F930GOT-K											
F920GOT (128 × 64)	F920GOT-K (24V)											

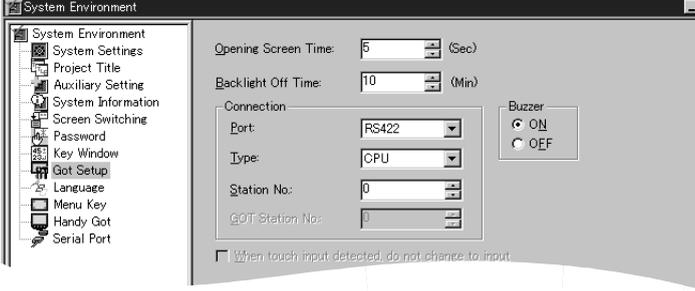

	Operation	Display (screen name)
	<p>Click "Got Setup" in the tree of the system environment menu.</p>  <p>e) Set the following.</p> <p>Port : RS-232C          Type : CPU          Station No. : 00 to 31          GOT Station No. : -</p> <p><u>In the case of F943 Handy GOT</u>          Without regard to the port setting (RS-422 or RS-232C), the COM0 side of the RS-232C is fixed for PLC connection.</p>	
[Change method]	<p>Change the connection type of the already created data as follows.</p> <p>a) Open GT Designer2.          b) Click the [Project]-[Open] button.          c) Open (read) the screen data to be changed.          d) On the menu, select "Common"-&gt;"System Environment".          - For the contents of setting, refer to c) of [Creation] above.          - For selection of the RS-232C on the SLC500 and MicroLogix Series PLCs, refer to e) of [Creation] above.</p>	<p>The "Select Project" dialog box appears.</p> <p>The "System Environment" dialog box appears.</p>

11	Connection of MELSEC-Q Series PLC
12	Connection of FX Series Positioning
13	Connection of FREQROL Inverter
14	Connection of Microcomputer
15	Connection of SYSMAC C Series PLC
16	Connection of FLEX-PC N Series PLC
17	Connection of Machine Controller
18	Connection of FP Series PLC
19	Connection of SLC500 Series PLC
20	Connection of SIMATIC S7 Series PLC



Operation		Display (screen name)
	<p>In the case of SW4D5C-GOTR-PACKE earlier than version A, perform the setting in the GOT-F900. (Set the connection in "CONNECTION" in the GOT-F900.) For the setting method, refer to "(1) GOT-F900 Series" on the previous page.</p> <p>e) Set the following.                      Port : RS-232C                      Type : CPU                      DST Station No. (Station No.) : 00 to 31                      GOT Station No. (-) : -</p>	
[Change method]	<p>Change the connection type of the already created data as follows.</p> <p>a) Open GT Designer.                      b) Click the [Open] button.                      c) Open (read) the screen data to be changed.                      d) On the menu, select "Common"- "GOT/PLC Type".                      - For the contents of setting, refer to c) of [Creation] above.                      - For selection of the RS-232C on the SLC500 and MicroLogix Series PLCs, refer to e) of [Creation] above.</p>	<p>The "Select Project" dialog box appears.</p> <p>The "GOT/PLC Type" dialog box appears.</p>

4) DU/WIN

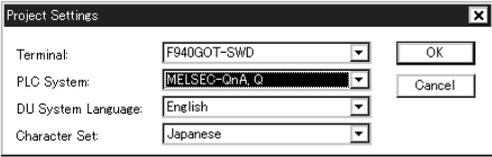
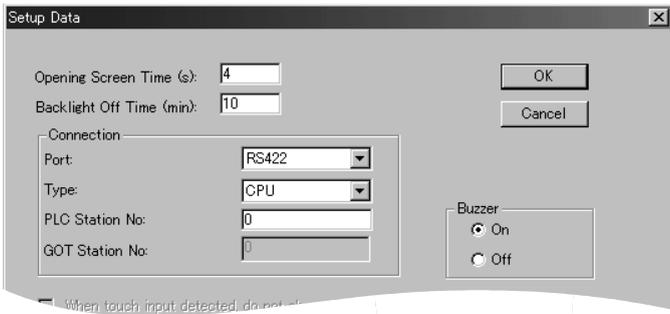
	Operation	Display (screen name)										
[Creation]	<p>a) Open the DU/WIN.</p> <p>b) On the menu, select "File"-"New".</p>  <p>c) Set the following.                      Terminal: F940WGOT-TWD (V)(H)                      F940GOT-LWD                      F940GOT-SWD                      F930GOT-BWD (V)(H)                      PLC System: AB-SLC500                      AB-MicroLogix</p> <p>Select "Terminal" in accordance with the LC display color.</p> <table border="1" data-bbox="464 853 1134 1137"> <thead> <tr> <th>Terminal</th> <th>Model name</th> </tr> </thead> <tbody> <tr> <td>F940WGOT-TWD (V)(H)</td> <td>F940WGOT (color)</td> </tr> <tr> <td>F940GOT-LWD</td> <td>F940GOT (black and white) Handy GOT (black and white)</td> </tr> <tr> <td>F940GOT-SWD</td> <td>F940GOT (color) Handy GOT (color)</td> </tr> <tr> <td>F930GOT-BWD (V)(H)</td> <td>F930GOT-K (blue) F930GOT (blue)</td> </tr> </tbody> </table> <p>d) Set CPU direct connection (RS-232C) of the GOT-F900.                      On the menu, select "View/Project"-"System Settings"-"Setup Data".</p>  <p>e) Set the following.                      Port: RS-232C                      Type: CPU                      DST Station No. (Station No.): 00 to 31                      GOT Station No. (-) : -</p>	Terminal	Model name	F940WGOT-TWD (V)(H)	F940WGOT (color)	F940GOT-LWD	F940GOT (black and white) Handy GOT (black and white)	F940GOT-SWD	F940GOT (color) Handy GOT (color)	F930GOT-BWD (V)(H)	F930GOT-K (blue) F930GOT (blue)	<p>The "Project settings" dialog box appears.</p> <p>The "Setup Data" dialog box appears.</p>
Terminal	Model name											
F940WGOT-TWD (V)(H)	F940WGOT (color)											
F940GOT-LWD	F940GOT (black and white) Handy GOT (black and white)											
F940GOT-SWD	F940GOT (color) Handy GOT (color)											
F930GOT-BWD (V)(H)	F930GOT-K (blue) F930GOT (blue)											
[Change method]	<p>Change the connection type of the already created data as follows.</p> <p>a) Open DU/WIN.</p> <p>b) On the menu, select "File"-"Open".</p> <p>c) Select and open (read) the file of the screen data to be changed.</p> <p>d) When changing "Terminal" (GOT-F900), select "View/Project"-"System Settings"-"Project settings" on the menu.                      - For the contents of setting, refer to c) of [Creation] above.                      - For selection of the RS-232C on the SLC500 and MicroLogix Series PLCs, refer to e) of [Creation] above.</p>	<p>The "Open" dialog box appears.</p> <p>The "Project settings" dialog box appears.</p>										

## 19.8 Cable Diagram

This section explains cable diagrams to connect the GOT-F900 and the SLC500/MicroLogix Series PLC manufactured by Allen-Bradley.

### 19.8.1 Cautions on preparing cables

When preparing the cables, use the wire size of 0.08mm<sup>2</sup> or more (AWG28 or more) for communication, 0.3mm<sup>2</sup> or more (AWG22 or more) for the power supply, operation switch, and emergency stop switch. Do not use a twisted pair cable with the power supply wire and the communication wire.

### 19.8.2 Cable diagram

#### 1) Cable for the GOT and the PLC manufactured by Allen-Bradley

 : Female type   
  : Male type   
 The connector figure shows the engagement face.

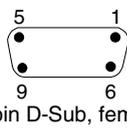
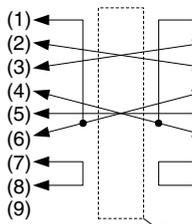
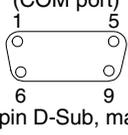
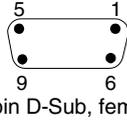
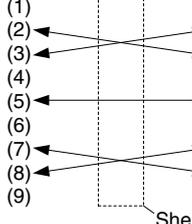
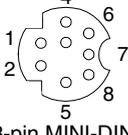
No.	Model name	Application	Connection diagram	Application
a)	RS-232C connection SLC500 Series Prepared by the user	To GOT-F900  9-pin D-Sub, female		To SLC500 (COM port)  9-pin D-Sub, male
b)	RS-232C connection MicroLogix Series*1 Prepared by the user	To GOT-F900  9-pin D-Sub, female		To MicroLogix (COM port)  8-pin MINI-DIN, male

\*1 1761-CBL-PM02 cable (Series C or later) manufactured by Allen-Bradley is available.

2) Cable for the F943 Handy GOT and the PLC manufactured by Allen-Bradley

When using the Handy GOT RH model, refer to the cable diagrams below for the RS-422/RS-232C connector, but not the wiring for the power supply, the operation switches, and the emergency stop switch because it is different. For details, refer to Section 5.18.

 : Female type  : Male type The connector figure shows the engagement face.

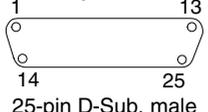
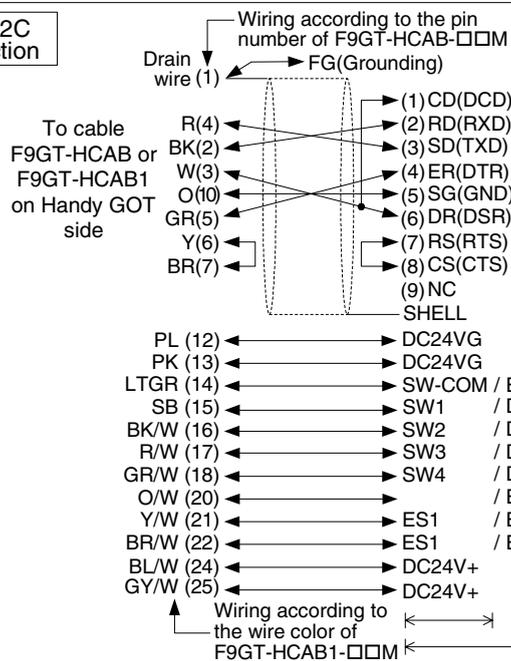
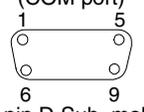
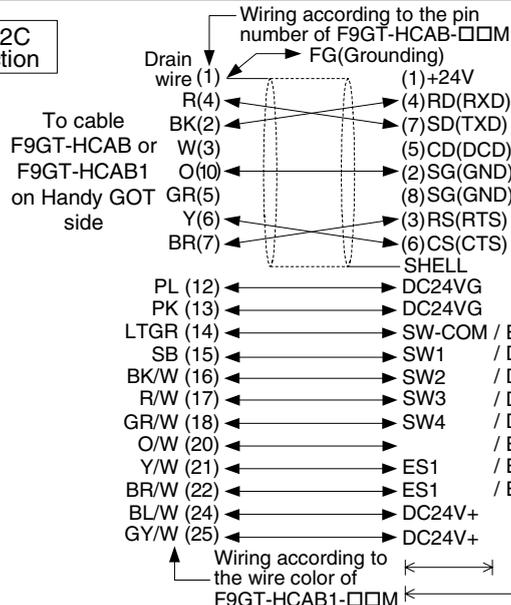
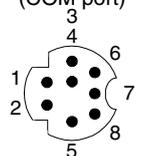
No.	Model name	Application	Connection diagram	Application	
a)	F9GT-HCAB-3M F9GT-HCAB-10M	<div style="border: 1px solid black; padding: 2px; display: inline-block;">RS-422 connection</div> <div style="border: 1px solid black; padding: 2px; display: inline-block;">RS-232C connection</div>	Dedicated connector on Handy GOT side	The connector on the leader side of the Handy GOT is dedicated, and cannot be prepared by the user.	To cable prepared by user  1 13 14 25 25-pin D-Sub, male
b)	F9GT-HCAB1-3M F9GT-HCAB1-10M	<div style="border: 1px solid black; padding: 2px; display: inline-block;">RS-422 connection</div> <div style="border: 1px solid black; padding: 2px; display: inline-block;">RS-232C connection</div>	Dedicated connector on Handy GOT side	The connector on the leader side of the Handy GOT is dedicated, and cannot be prepared by the user.	Loose wires (no connector)
c)	SLC500 Series Prepared by the user	<div style="border: 1px solid black; padding: 2px; display: inline-block;">RS-232C connection</div>	 <p>Wiring according to the pin number of F9GT-HCAB-□□M</p> <p>Drain wire (1) → FG (Grounding)</p> <p>To cable F9GT-HCAB or F9GT-HCAB1 on Handy GOT side</p> <p>(1) CD(DCD)                      (2) RD(RXD)                      (3) SD(TXD)                      (4) ER(DTR)                      (5) SG(GND)                      (6) DR(DSR)                      (7) RS(RTS)                      (8) CS(CTS)                      (9) NC                      SHELL</p> <p>PL (12) → DC24VG                      PK (13) → DC24VG                      LTGR (14) → SW-COM / ES1-2                      SB (15) → SW1 / DSW2                      BK/W (16) → SW2 / DSW2                      R/W (17) → SW3 / DSW1                      GR/W (18) → SW4 / DSW1                      O/W (20) → / ES1-2                      Y/W (21) → ES1 / ES1-1                      BR/W (22) → ES1 / ES1-1                      BL/W (24) → DC24V+                      GY/W (25) → DC24V+</p> <p>Wiring according to the wire color of F9GT-HCAB1-□□M</p> <p>Old cable description → New cable description</p>	To SLC500 side (COM port)  1 5 6 9 9-pin D-Sub, male  Wire the power supply, the operation switches and the emergency stop switch.	
d)	MicroLogix Series Prepared by the user	<div style="border: 1px solid black; padding: 2px; display: inline-block;">RS-232C connection</div>	 <p>Wiring according to the pin number of F9GT-HCAB-□□M</p> <p>Drain wire (1) → FG (Grounding)</p> <p>To cable F9GT-HCAB or F9GT-HCAB1 on Handy GOT side</p> <p>(1) +24V                      (4) RD(RXD)                      (7) SD(TXD)                      (5) CD(DCD)                      (2) SG(GND)                      (8) SG(GND)                      (3) RS(RTS)                      (6) CS(CTS)                      SHELL</p> <p>PL (12) → DC24VG                      PK (13) → DC24VG                      LTGR (14) → SW-COM / ES1-2                      SB (15) → SW1 / DSW2                      BK/W (16) → SW2 / DSW2                      R/W (17) → SW3 / DSW1                      GR/W (18) → SW4 / DSW1                      O/W (20) → / ES1-2                      Y/W (21) → ES1 / ES1-1                      BR/W (22) → ES1 / ES1-1                      BL/W (24) → DC24V+                      GY/W (25) → DC24V+</p> <p>Wiring according to the wire color of F9GT-HCAB1-□□M</p> <p>Old cable description → New cable description</p>	To MicroLogix (COM port)  1 3 4 6 7 8 2 5 8-pin MINI DIN, female  Wire the power supply, the operation switches and the emergency stop switch.	

## 19.9 Troubleshooting

For reference, this section summarizes frequently asked questions about connection of the GOT-F900 to the SLC500/MicroLogix Series PLC manufactured by Allen-Bradley.

### 1) GOT-F900

Contents of trouble	Check points and countermeasures	OS version		
		F940W	F940	F930
"COMMUNICATION ERROR OCCURS" is displayed when a screen changeover or numeric data input is performed on the GOT-F900 screen.	The power of the SLC500/MicroLogix Series PLC is turned off. <ul style="list-style-type: none"> <li>• Cause Communication is disabled because the power of the SLC500/MicroLogix Series PLC is turned off.</li> <li>• Countermeasures Turn on the power.</li> </ul>	From first product	From first product	From first product
	Something is wrong with the cable between the GOT-F900 and the SLC500/MicroLogix Series PLC. <ul style="list-style-type: none"> <li>• Causes The wrong cable is used or the connection is bad.</li> <li>• Countermeasures Check the cable.</li> </ul>			
"DISPLAY SCREEN IS NOT AVAILABLE." is displayed on the GOT-F900 screen.	Changeover to a nonexistent screen by a touch key or the SLC500/MicroLogix Series PLC was tried. <ul style="list-style-type: none"> <li>• Cause The changeover destination screen has not been created yet.</li> <li>• Countermeasures Create the screen.</li> </ul>	-	Earlier than 6.00	Earlier than 4.00
"DISPLAY SCREEN IS NOT AVAILABLE. (NO. ####)" is displayed on the GOT-F900 screen.	A nonexistent screen was tried to be displayed. <ul style="list-style-type: none"> <li>• Cause The screen No. #### has not been created yet.</li> <li>• Countermeasures Create the screen.</li> </ul>	From first product	6.00 or later	4.00 or later
"DISPLAY SCREEN IS NOT AVAILABLE." is displayed on the GOT-F900 screen.	A device that does not exist in the SLC500/MicroLogix Series was referenced. (Example: While an SLC500 is connected, a device exists only in the MicroLogix is specified for numeric input.) <ul style="list-style-type: none"> <li>• Cause On the changeover destination screen (excluding the head screen), a nonexistent device in the connected SLC500/MicroLogix Series PLC is specified.</li> <li>• Countermeasures Check the devices used on the head screen.</li> </ul>	-	Earlier than 6.00	Earlier than 4.00
	There is an error on the screen to be displayed. <ul style="list-style-type: none"> <li>• Cause One of the screen objects is placed outside the available screen area.</li> <li>• Countermeasures Check the placement of screen objects.</li> </ul>			

Contents of trouble	Check points and countermeasures	OS version		
		F940W	F940	F930
"DISPLAY SCREEN IS NOT AVAILABLE. (NO. ####)" is displayed on the GOT-F900 screen.	<p>The display screen contains an error.</p> <ul style="list-style-type: none"> <li>Causes A device that does not exist in the connected PLC is referenced on the screen No. ####, or one of the screen objects is placed outside the available screen area.</li> <li>Countermeasures Check the devices used and placement of screen objects.</li> </ul>	From first product	6.00 or later	4.00 or later
"DATA IS NOT FOUND." is displayed on the GOT-F900 screen.	<p>There is not data because the unit is new or the memory clear has been executed.</p> <ul style="list-style-type: none"> <li>Cause There is no screen data.</li> <li>Countermeasures Write the screen data using the screen creation software.</li> </ul>	-	Earlier than 6.00	Earlier than 4.00
	<p>A device that does not exist in the SLC500/MicroLogix Series PLC was referenced. (Example: While an SLC500 is connected, a device exists only in the MicroLogix is specified for numeric input.)</p> <ul style="list-style-type: none"> <li>Cause On the head screen, a nonexistent device in the connected SLC500/MicroLogix Series PLC is specified. (The head screen is the screen No. 1 in the GT Designer, and the screen No. 0 in the DU/WIN.)</li> <li>Countermeasures Check the devices used on the head screen.</li> </ul>			
	<p>There is not data because the unit is new or the memory clear has been executed.</p> <ul style="list-style-type: none"> <li>Cause There is no screen data.</li> <li>Countermeasures Write the screen data using the screen creation software.</li> </ul>	From first product	6.00 or later	4.00 or later
"CAN NOT WRITE TO PLC MEMORY." is displayed on the GOT-F900 screen.	This error is not displayed.	Earlier than 1.10	Earlier than 6.10	Earlier than 4.10
"CAN NOT WRITE." is displayed on the GOT-F900 screen.	This error is not displayed.	1.10 or later	6.10 or later	4.10 or later
"CAN NOT USE THE FUNCTION WHILE PROTECTED." is displayed on the GOT-F900 screen.	This error is not displayed.	From first product	From first product	From first product
"PLC IS RUNNING." is displayed on the GOT-F900 screen.	This error is not displayed.	From first product	From first product	From first product



2) Software

	Contents of trouble	Check points and countermeasures
Screen creation software	<p>In the personal computer connected to the GOT-F900, screen data cannot be transferred. Communication with the screen creation software is disabled. An error message is displayed.</p>	<p>A SLC500/MicroLogix Series PLC, bar code reader or printer is connected.</p> <ul style="list-style-type: none"> <li>• Causes The RS-232C connector to which the personal computer is connected is set to be used for another piece of equipment.</li> <li>• Countermeasures In the GOT-F900, select by hand "SELECT MODE"- "OTHER MODE"- "DATA TRANSFER". Or set a bar code reader to invalid and a printer to "DON'T USE".</li> </ul> <hr/> <p>Something is wrong with the cable between the GOT-F900 and the personal computer.</p> <ul style="list-style-type: none"> <li>• Causes The wrong cable is used or the connection is bad.</li> <li>• Countermeasures Check the cable.</li> </ul>

11

Connection of MELSEC-Q Series PLC

12

Connection of FX Series Positioning

13

Connection of FREQROL Inverter

14

Connection of Microcomputer

15

Connection of SYSMAC C Series PLC

16

Connection of FLEX-PC N Series PLC

17

Connection of Machine Controller

18

Connection of FP Series PLC

19

Connection of SLC500 Series PLC

20

Connection of SIMATIC S7 Series PLC

# MEMO

## 20. Connection of SIMATIC S7-200/300/400 Series PLC (Manufactured by Siemens AG)

This chapter explains the procedure to connect the GOT-F900 Series display unit to the SIMATIC S7-200/300/400 Series PLC.

### Connection Procedure

This section introduces the procedure to connect the GOT-F900 to the SIMATIC S7-200/300/400 Series PLC.

#### 1. Preparation

Item name	Description	Reference
System Condition	You can learn the connection availability as well as the version of the GOT-F900 OS and the screen creation software.	20.1
System Configuration	You can select the configuration between the GOT and the SIMATIC S7-200/300/400 Series PLC and proper cables. You can learn options such as adapter and cable manufactured by Siemens AG.	20.2

#### 2. Setting

Item name	Description	Reference		
Setting in SIMATIC S7-200	You can learn the communication specifications and the contents of setting.		20.3	
	Communication Setting Specifications	The transmission specifications set in the SIMATIC S7-200		20.3.1
	GOT-F900 Transmission Specifications	The transmission specifications set in the GOT-F900		20.3.2
SIMATIC S7-300/400 Selection	You can learn the communication specifications and the contents of setting.		20.4	
	Communication Setting Specifications	The transmission specifications set in the SIMATIC S7-300/400		20.4.1
	GOT-F900 Transmission Specifications	The transmission specifications set in the GOT-F900		20.4.2
Device Specification Method	You can learn devices which can be monitored in the GOT and their formats.		20.5	
	Device Format in SIMATIC S7-200	How to see devices		20.5.1
	Device Format in SIMATIC S7-300/400	The supplementary explanation in device specification		20.5.2
	Supplementary Items	Cautions on unavailable devices	20.5.3	
Caution on Use of SIMATIC S7-200/300/400 Series PLC	You can learn the restrictions in connecting the GOT to the SIMATIC S7-200/300/400 Series PLC.	20.6		
Setting of Connected Equipment for GOT	Set the connected PLC type using the GOT or the screen creation software.	20.7		

### 3. Others

Item name	Description	Reference
Cable Diagram	Cable diagrams for SIMATIC S7-200/300/400 Series PLC and GOT connection	20.8
Troubleshooting	Description of errors and how to fix them	20.9

## 20.1 System Condition

When connecting the SIMATIC S7-200/300/400 Series PLC, check the COM port designation, the OS version of the GOT-F900, and applicable versions of the screen creation software.

Compatibility when connecting SIMATIC S7-200 Series PLC

GOT-F900 Series	COM port		Connection type		OS version of GOT-F900	Version of screen creation software		
	RS-422	RS-232C	1:1	Two or more GOT units		GT Designer2	GT Designer	DU/WIN
F920GOT-K(5V)	-	-	-	-	-	-	-	-
F920GOT-K(24V)	-	-	-	-	-	-	-	-
F930GOT	-	✓	✓	-	4.20	SW1-C	SW5-R	2.52
F930GOT-K	-	✓	✓	-	4.60	SW1-C	SW5-26C	2.70
F940GOT	-	✓	✓	-	6.20	SW1-C	SW5-R	2.52
F940WGOT	-	✓	✓	-	1.20	SW1-C	SW5-R	2.52
F940 Handy GOT	-	-	-	-	It cannot be connected. Select the F943 Handy GOT.			
F943 Handy GOT	-	✓	✓	-	6.20	SW1-C	SW5-R	2.52

Compatibility when connecting SIMATIC S7-300/400 Series PLC

GOT-F900 Series	COM port		Connection type		OS version of GOT-F900	Version of screen creation software		
	RS-422	RS-232C	1:1	Two or more GOT units		GT Designer2	GT Designer	DU/WIN
F920GOT-K(5V)	-	-	-	-	-	-	-	-
F920GOT-K(24V)	-	✓	✓	-	1.20	SW1-C	-	-
F930GOT	-	✓	✓	-	3.00	SW1-C	SW5-F	2.40
F930GOT-K	-	✓	✓	-	4.60	SW1-C	SW5-26C	2.70
F940GOT	-	✓	✓	-	5.00	SW1-C	SW5-F	2.40
F940WGOT	-	✓	✓	-	1.00	SW1-C	SW5-F	2.50
F940 Handy GOT	-	-	-	-	It cannot be connected. Select the F943 Handy GOT.			
F943 Handy GOT	-	✓	✓	-	5.00	SW1-C	SW5-F	2.40

## 20.2 System Configuration

The SIMATIC S7-200/300/400 Series PLC can be directly connected to the GOT via RS-232C. This section explains the cables and options required in such a system.

### 20.2.1 Applicable model

The GOT-F900 can be connected to the following equipment in accordance with its OS version. Operations are not assured when the GOT-F900 is connected to any other equipment. For details of the OS version of the GOT-F900 and applicable equipment, refer to "3.1 OS Version and Correspondence to Connected Equipment of GOT-F900".

CPU	OPTION	COMMUNICATION PORT
S7-200 series	PC/PPI cable (6ES7 901-3BF20-0XA0)	Connection to built-in port (Excluding F920GOT-K.)
S7-300 series S7-400 series	HMI adapter (6ES7 972-0CA11-0XA0)	Connection to built-in port

11

Connection of  
MELSEC-Q  
Series PLC

12

Connection of  
FX Series  
Positioning

13

Connection of  
FREQUOL  
Inverter

14

Connection of  
Microcom-  
puter

15

Connection of  
SYSMAC C  
Series PLC

16

Connection of  
FLEX-PC N  
Series PLC

17

Connection of  
Machine Con-  
troller

18

Connection of  
FP Series PLC

19

Connection of  
SLC500  
Series PLC

20

Connection of  
SIMATIC S7  
Series PLC

### 20.2.2 Configuration for CPU Direct Connection (RS-232C)

Connect the connector on the PPI side of the PC/PPI cable (6ES7 901-3BF20-0XA0) to the SIMATIC S7-200 Series CPU, then connect the connector on the PC side to the RS-232C communication port of the GOT.

Connect the HMI adapter (6ES7 972-0CA11-0XA0) to the SIMATIC S7-300/400 Series CPU, then connect the RS-232C port of the HMI adapter to the RS-232C port of the GOT with a dedicated cable (6ES7 972-0CA10-0XA0).

#### 1) F920GOT-K (24V type)/F930GOT/F930GOT-K/F940GOT/F940WGOT

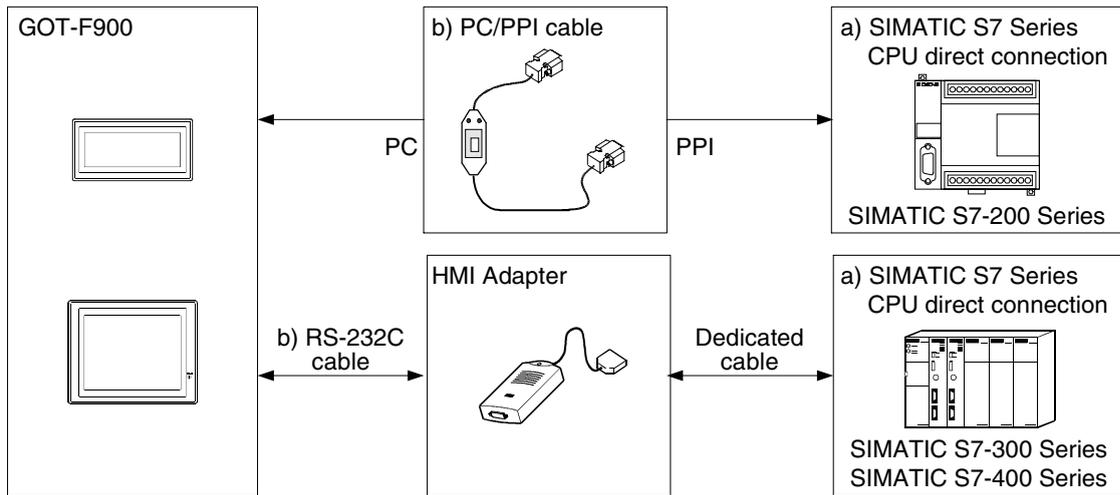

SIMATIC S7-200 Series (Excluding the 5V type F920GOT-K.)

a) SISMAC S7		b) PC/PPI cable	Remarks
212	9-pin D-Sub (connector of PC/PPI cable)	6ES7 901-3BF20-0XA0 cable manufactured by Siemens AG	
214			
215			
216			
221			
222			
224			

SIMATIC S7-300 Series

a) SISMAC S7		b) RS-232C cable	Remarks
312IFM	9-pin D-Sub (port of HMI adapter)	6ES7 972-0CA00-0XA0 cable manufactured by Siemens AG is also available.	
313			
314			
314IFM			
315			
315-2DP			
316			

SIMATIC S7-400 Series

a) SIMATIC S7		b) RS-232C cable	Remarks
412-1	9-pin D-Sub (port of HMI adapter)	Prepared by the user	
413-1		Cable 6ES7 972-0CA00-0XA0 manufactured by Siemens AG is also available.	
413-2DP			
414-1			
414-2DP			
416-1			
416-2DP			

2) F943 Handy GOT

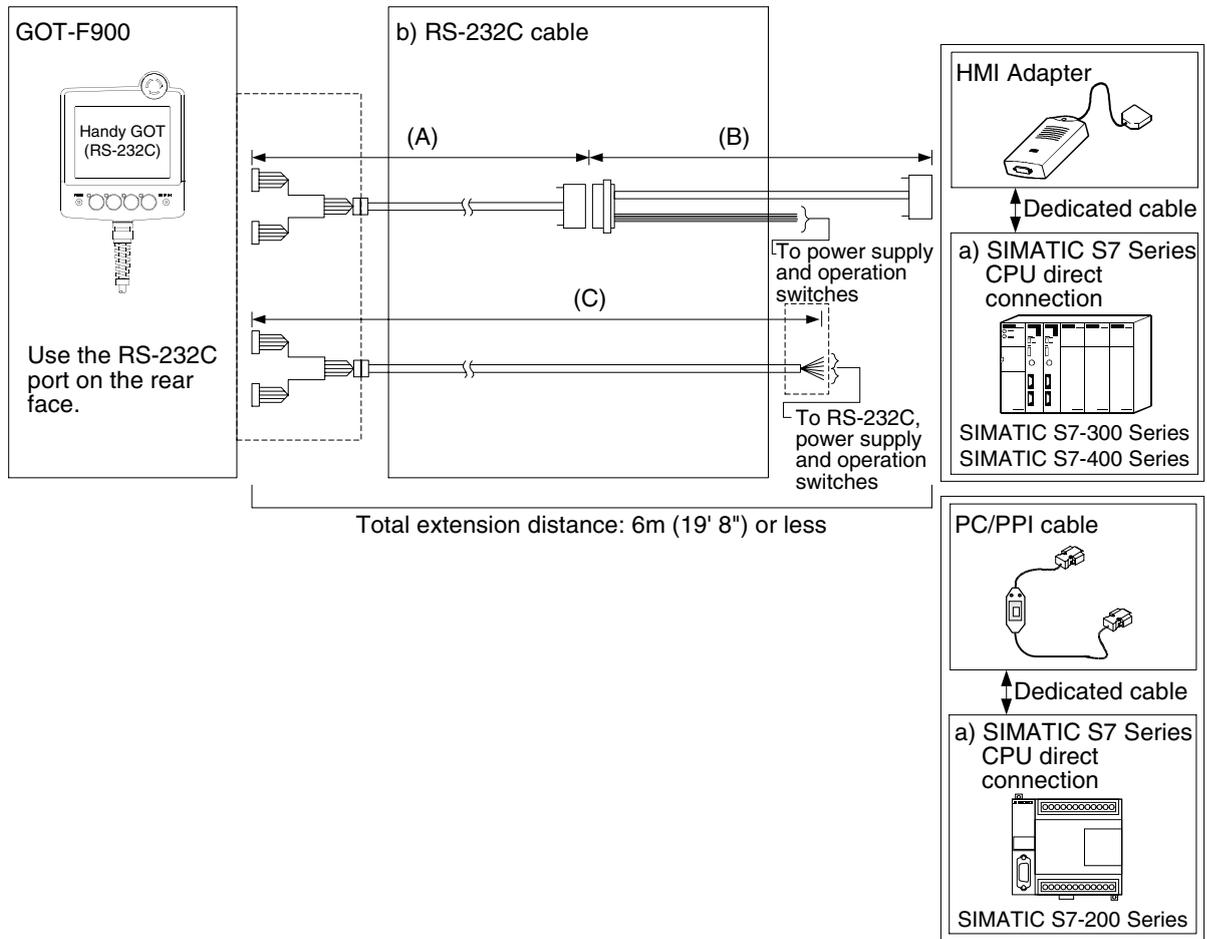

SIMATIC S7-200 Series

a) SIMATIC S7		b) RS-232C cable	Remarks
212	9-pin D-Sub (connector of PC/PPI cable)	(A) F9GT-HCAB-□□M	
214		(B) Prepared by the user	
215		(C) F9GT-HCAB1-□□M	
216			
221			
222			
224			

SIMATIC S7-300 Series

a) SISMALC S7		b) RS-232C cable	Remarks
312IFM	9-pin D-Sub (port of HMI adapter)	(A) F9GT-HCAB-□□M	
313		(B) Prepared by the user	
314		(C) F9GT-HCAB1-□□M	
314IFM			
315			
315-2DP			
316			

SIMATIC S7-400 Series

a) SISMALC S7-400		b) RS-232C cable	Remarks
412-1	9-pin D-Sub (port of HMI adapter)	(A) F9GT-HCAB-□□M	
413-1		(B) Prepared by the user	
413-2DP		(C) F9GT-HCAB1-□□M	
414-1			
414-2DP			
416-1			
416-2DP			

- Make sure that the total cable extension distance "(A) + (B)" or (C) is 6m (19' 8") or less.

20.2.3 Introduction of Options Manufactured by Siemens AG

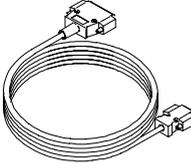
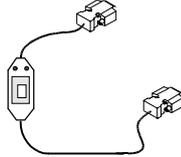
Product name	Model name	Description
Cable	6ES7 972-0CA00-0XA0	This RS-232C cable connects the GOT-F900 (excluding the Handy GOT) and the HMI adapter. 
HMI Adapter	6ES7 972-0CA11-0XA0	This interface is required to connect the GOT-F900 to the SIMATIC S7-300/400 Series CPU. 
PC/PPI cable	6ES7 901-3BF20-0XA0	This RS-232C/RS-485 conversion cable is required to connect the GOT-F900 to the PPI port of the SIMATIC S7-200 Series CPU. 



## 20.3 Setting in SIMATIC S7-200

When connecting the SIMATIC S7-200 Series PLC, the communication specifications of the RS-232C port should be set using the peripheral equipment for the SIMATIC S7-200 Series (STEP7-Micro/WIN).

### 20.3.1 Communication Setting Specifications

Set the baud rate, highest address, etc. of the SIMATIC S7-200 Series PLC.

#### 1) Setting in the PLC

Set the following items using the programming software for the SIMATIC S7-200 Series (STEP7-Micro/WIN32).

Item	Set value
PLC Address	1 to 31
Highest Address	31
Baud Rate	19200 bps
Retry Count	3
Gap Update Factor	10

#### Procedure

- Open STEP7-Micro/WIN32 software.
- From the menu on the tool bar, select "View"->"Communications".  
Set "Remote Address" to the destination PLC station number (The default value is "2".)
- From the menu on the tool bar, select "View"->"System Block".  
Set "PLC Address" to a value in the range from 1 to 31, "Highest Address" to "31", "Baud Rate" to "19.2 kbps", "Retry Count" to "3", and "Gap Update Factor" to "10".  
Click the [OK] button.
- Transfer the program to the PLC.

11

Connection of  
MELSEC-Q  
Series PLC

12

Connection of  
FX Series  
Positioning

13

Connection of  
FREQROL  
Inverter

14

Connection of  
Microcom-  
puter

15

Connection of  
SYSMAC C  
Series PLC

16

Connection of  
FLEX-PC N  
Series PLC

17

Connection of  
Machine Con-  
troller

18

Connection of  
FP Series PLC

19

Connection of  
SLC500  
Series PLC

20

Connection of  
SIMATIC S7  
Series PLC

**2) Setting of the PC/PPI cable (6ES7 901-3BF20-0XA0)**

Set the DIP switches as shown below.

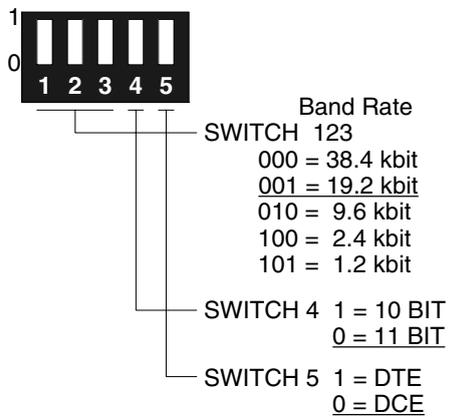
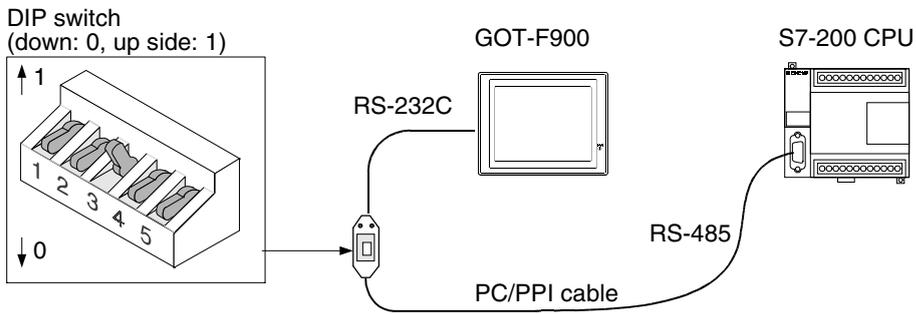

### 20.3.2 GOT-F900 Transmission Specifications

#### 1) Transmission specifications

The GOT-F900 is set to the following communication specifications.

Item		Set value
Transmission speed		19200 bps
Data format	Data bit	8 bits
	Parity bit	Provided (even)
	Stop bit	1 bit

- The specifications such as the transmission speed are fixed on the GOT-F900 side, and cannot be changed.

#### 2) Setting of the station number

In the settings in the GOT-F900, the destination station number (DST STA #) corresponds to the PLC address in the SIMATIC S7-200 Series PLC.

And the GOT station number (GOT STA #) corresponds to the GOT-F900 station number. Make sure to set a different value in the range from 0 to 31 to the DST STA # and GOT STA # respectively.

### 20.4 Setting in SIMATIC S7-300/400

When connecting the SIMATIC S7-300/400 Series PLC, the communication specifications and the usage of the RS-232C port should be set using the peripheral equipment for the SIMATIC S7-300/400 Series (STEP7).

#### 20.4.1 Communication Setting Specifications

Set the MPI address of the SIMATIC S7-300/400 Series PLC using the programming software for the SIMATIC S7-300/400 Series (STEP7).

Item	MPI address
Personal computer (for programming)	0 (fixed in MPI network)
HMI adapter	1 (fixed)
SIMATIC S7-300/400 Series PLC	02 to 31

The MPI address of the HMI adapter is fixed to "01", and the highest MPI address is "31".

Accordingly, make sure to set the MPI address of the SIMATIC S7-300 Series PLC in the range from 2 to 31.

#### 20.4.2 GOT-F900 Transmission Specifications

##### 1) Transmission specifications

The GOT-F900 is set to the following communication specifications.

Item		Set value
Transmission speed		38400 bps
Data format	Data bit	8 bits
	Parity bit	Provided (even)
	Stop bit	1 bit

- The specifications such as the transmission speed are fixed on the GOT-F900 side, and cannot be changed.

##### 2) Setting of the MPI address (station number) setting switch

The GOT-F900 station number corresponds to the MPI address in the SIMATIC S7-300/400 Series PLC.

Accordingly, align the destination station number (or DST STA #) of the GOT-F900 with the MPI address.

If the destination station number of the GOT-F900 is set to "00" or "01", it is treated as "02".

11	Connection of MELSEC-Q Series PLC
12	Connection of FX Series Positioning
13	Connection of FREQROL Inverter
14	Connection of Microcomputer
15	Connection of SYSMAC C Series PLC
16	Connection of FLEX-PC N Series PLC
17	Connection of Machine Controller
18	Connection of FP Series PLC
19	Connection of SLC500 Series PLC
20	Connection of SIMATIC S7 Series PLC

## 20.5 Device Specification Method

This section explains the format used to specify devices of the SIMATIC S7-200/300/400 Series. For the device range which can be set in the GOT-F900, refer to section 3.3.

### 20.5.1 Device Format in SIMATIC S7-200

GT Designer version SW5-P (5.13P) or later		DU/WIN version 2.60 or later	
Bit device (except timer and counter)	▲ <u>○○○○</u> □ a)      b)      c)	Bit device (except timer and counter)	▲ <u>○○○○</u> . □ a)      b)      c)
Bit device Word device (timer and counter)	▲ <u>○○○○</u> a)      b)	Bit device Word device (timer and counter)	▲ <u>○○○○</u> a)      b)
Word device (except timer and counter)	▲ <u>○○○○</u> a)      b)	Word device (except timer and counter)	▲ <u>○○○○</u> a)      b)

#### 1) Bit device (except timer and counter)

- Specify the device symbol in an alphabet.
- Specify the device (byte) number corresponding to each device.

GT Designer	DU/WIN
1- to 4-digit decimal number (without 0 suppression)	1- to 4-digit decimal number (with 0 suppression)

- Specify the bit position in a 1-digit number (0 to 7).

Example: To specify "M20.5"  
 Device symbol ..... M  
 Device (byte) number ..... 20  
 Bit position ..... 5

#### 2) Bit device and word device (timer and counter)

The specification method is equivalent to that of the bit device except "c) Specify the bit position".

- Specify the device symbol in an alphabet.
- Specify the device (byte) number corresponding to each device.

GT Designer	DU/WIN
1- to 4-digit decimal number (with 0 suppression)	1- to 4-digit decimal number (with 0 suppression)

Example: To specify Timer (T) (present value) "T250"  
 Device symbol ..... T  
 Device (byte) number ..... 250

#### 3) Word device (except timer and counter)

- Specify the device symbol in two or three alphabets.
- Specify the device (byte) number corresponding to each device.

GT Designer	DU/WIN
1- to 4-digit decimal number (with 0 suppression) (Only an even number can be specified.*1)	1- to 4-digit decimal number (with 0 suppression) (Only an even number can be specified.*1)

Example: To specify Special memory "MW25"  
 Device symbol ..... MW  
 Device (byte) number ..... 25

\*1 Except the high speed counter (HC)

### 20.5.2 Device Format in SIMATIC S7-300/400

GT Designer version SW5-F (5.05F) or later		DU/WIN	
Bit device	▲ <u>○○○○</u> □ a)      b)      c)	Bit device (except timer and counter)	▲ <u>○○○○</u> . □ a)      b)      c)
Word device (timer and counter)	▲ <u>○○○○</u> a)      b)	Bit device Word device (timer and counter)	▲ <u>○○○○</u> a)      b)
Word device (data register)	<u>D</u> <u>○○○○</u> <u>□□□□</u> a)      b)      c)	Word device (except timer and counter)	<u>DB</u> <u>○○○○</u> . <u>DBW</u> <u>□□□□</u> a)      b)      c)

#### 1) Bit device

- Specify the device symbol in an alphabet.
- Specify the device (byte) number corresponding to each device.

GT Designer	DU/WIN
3- to 4-digit decimal number (without 0 suppression)	1- to 4-digit decimal number (with 0 suppression)

- Specify the bit position in a 1-digit number (0 to 7).

Example: "M01205"  
 Device symbol ..... M  
 Device (byte) number ..... 0120  
 Bit position ..... 5

#### 2) Word device (timer and counter)

The specification method is equivalent to that of the bit device except "c) Specify the bit position".

- Specify the device symbol in an alphabet.
- Specify the device (byte) number corresponding to each device.

GT Designer	DU/WIN
3- to 4-digit decimal number (without 0 suppression)	1- to 4-digit decimal number (with 0 suppression)

Example: Timer (T) (present value) "T250"  
 Device symbol ..... T  
 Device (byte) number ..... 250

#### 3) Word device (data register)

- Specify the device symbol in two alphabets ("D" or "DB").
- Specify the block number corresponding to each device.

GT Designer	DU/WIN
4-digit decimal number (without 0 suppression)	1- to 4-digit decimal number (with 0 suppression)

- Specify the device (byte) number corresponding to each device.

GT Designer	DU/WIN
5-digit decimal number (without 0 suppression) (Only an even number can be specified.)	1- to 5-digit decimal number (with 0 suppression) (Only an even number can be specified.)

Example: Data register (D) "D102031004"  
 Device symbol ..... D  
 Block number ..... 1020  
 Device (byte) number ..... 31004

### 20.5.3 Supplementary Items

#### 1) Data register specification

Define data blocks for the SIMATIC S7-300 Series PLC CPU using the STEP7 in advance, and download them to the CPU.

#### 2) I/O relay

The English (IEC) expression is used in the GOT-F900.

When the German (SIMATIC) expression is selected in the STEP7, devices E, A and Z are equivalent to I, Q and C respectively.

#### 3) Device check range

Because the GOT-F900 does not discriminate the CPU type between the S7-300 Series CPU and the S7-400 Series CPU, the device range is in accordance with "devices which can be monitored".

For the device range which can be set in the GOT-F900, refer to section 2.3.

#### 4) Peripheral equipment for the SIMATIC S7-300/400 Series

The STEP7 is the name of the programming software for the SIMATIC S7-300/400 Series.

## 20.6 Caution on Use of SIMATIC S7-200/300/400 Series PLC

When using the GOT-F900 connected to the SIMATIC S7-200/300/400 Series PLC, observe the following cautions on use.

### 20.6.1 Restriction in devices depending on the model

Some devices are not available in the 416-1 and the 416-2DP.

### 20.6.2 Restriction in device specification

Word specification of bit devices and bit specification of word devices are not enabled in the GOT-F900.

## 20.7 Setting of Connected Equipment for GOT

The SIMATIC S7-200/300/400 Series PLC connection parameters can be set using the GOT-F900 Series and the screen creation software (GT Designer 2, GT Designer or DU/WIN).

### 1) GOT-F900 Series

When the main menu screen change operation is disabled.

Operation	Display (screen name)
a) While pressing and holding the upper left corner of the screen, turn on the power. Keep holding the upper left corner for about 25 seconds more. Then, press "END" at the upper right corner.	The "LANGUAGE" screen appears.
b) Press "PLC TYPE".	The "SET-UP MODE" screen appears.
c) Set the following. PLC TYPE: SIEMENS S7-200 SIEMENS S7-300 CONNECTION: CPU PORT (RS-232C) (S7-200) DST STATION # : 1 to 31 GOT STATION # : 0 to 31  (S7-300) DST STATION # (STATION #): 02 to 31 ("00" and "01" are treated as "02".) GOT STATION # (-) : -	The "PLC TYPE" screen appears.

When the main menu screen change operation is enabled.

Operation	Display (screen name)
a) Press the upper left corner of the screen. (The position to be pressed can be changed in the GOT and the screen creation software.)	The "SELECT MODE" screen appears.
b) Press "OTHER MODE" on the menu.	The "OTHER MODE" screen appears.
c) Press "SET-UP MODE" on the menu.	The "SET-UP MODE" screen appears.
d) Press "PLC TYPE".	The "PLC TYPE" screen appears.
e) Set the following. PLC TYPE: SIEMENS S7-200 SIEMENS S7-300 CONNECTION: CPU PORT (RS-232C) (S7-200) DST STATION # : 1 to 31 GOT STATION # : 0 to 31 (S7-300) DST STATION # (STATION #): 02 to 31 ("00" and "01" are treated as "02".) GOT STATION # (-) : -	

- When the screen data is transferred to the GOT-F900, the old data including the PLC type, connection type, and station number are overwritten.

2) GT Designer2

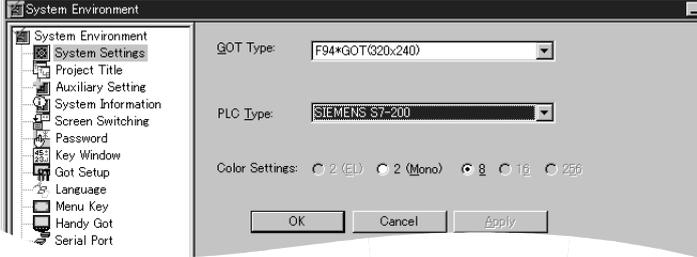
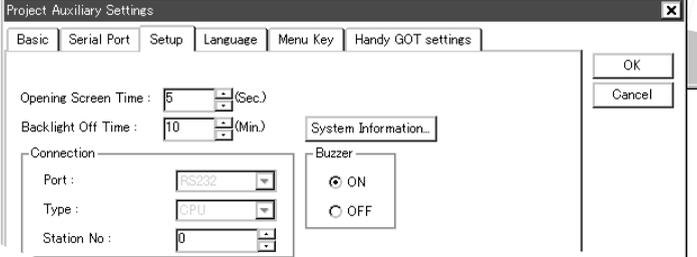
	Operation	Display (screen name)										
[Creation]	<p>a) Open GT Designer2.</p> <p>b) Click the [NEW] button. The dialog box shown below is displayed. If it is not displayed, click "System Environment" in the tree displayed in the project work space, then click "System settings" in the tree.</p>   <p>c) Set the following.                      GOT type: F940WGOT (480 × 234)                              F94*GOT (320 × 240)                              F93*GOT (240 × 80)                              F920GOT (128 × 64)                      PLC type: SIEMENS S7-200 (Excluding the F920GOT-K.)                              SIEMENS S7-300 (Excluding the 5V type F920GOT-K.)                      Selection of "GOT type"</p> <table border="1" data-bbox="485 1357 1114 1617"> <thead> <tr> <th>GOT type</th> <th>Model name (name)</th> </tr> </thead> <tbody> <tr> <td>F940WGOT(480×234)&lt;WIDE&gt;</td> <td>F940WGOT</td> </tr> <tr> <td>F94*GOT(320×240)</td> <td>F940GOT Handy GOT</td> </tr> <tr> <td>F930GOT(240×80)</td> <td>F930GOT F930GOT-K</td> </tr> <tr> <td>F920GOT(128×64)</td> <td>F920GOT-K</td> </tr> </tbody> </table> <p>Click [OK].</p>	GOT type	Model name (name)	F940WGOT(480×234)<WIDE>	F940WGOT	F94*GOT(320×240)	F940GOT Handy GOT	F930GOT(240×80)	F930GOT F930GOT-K	F920GOT(128×64)	F920GOT-K	<p>The "Select Project" dialog box appears.</p> <p>The "System Environment" dialog box appears.</p>
GOT type	Model name (name)											
F940WGOT(480×234)<WIDE>	F940WGOT											
F94*GOT(320×240)	F940GOT Handy GOT											
F930GOT(240×80)	F930GOT F930GOT-K											
F920GOT(128×64)	F920GOT-K											

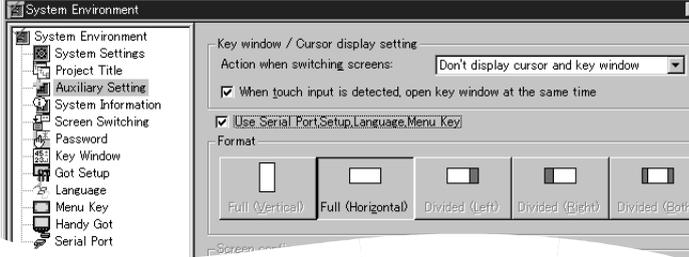
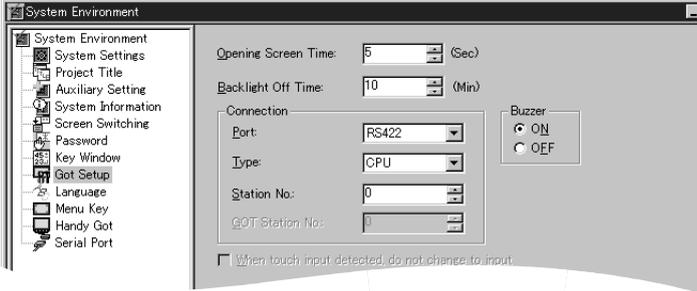

	Operation	Display (screen name)
	<p>d) Setting the port (RS-232C) of the GOT-F900</p> <p>Click "Auxiliary Setting" in the tree of the system environment menu.</p> <p>Click the check box of "Use Serial Port, Setup, Language, Menu Key" to give a check mark (✓).</p>  <p>Click "Got Setup" in the tree of the system environment menu.</p>  <p>e) Set the following.</p> <p>Port : RS-232C Type : CPU (S7-200) Station No. : 1 to 31 GOT Station No. : 0 to 31 (S7-300) Station No. : 02 to 31 ("00" and "01" are treated as "02".) GOT Station No.:—</p> <p><u>In the case of F943 Handy GOT</u> Without regard to the port setting (RS-422 or RS-232C), the COM0 side of the RS-232C is fixed for PLC connection.</p>	<p>The "Auxiliary Settings" dialog box appears.</p>
[Change method]	<p>Change the connection type of the already created data as follows.</p> <p>a) Open GT Designer2.</p> <p>b) Click the [Project]-[Open] button.</p> <p>c) Open (read) the screen data to be changed.</p> <p>d) On the menu, select "Common"-&gt;"System Environment".</p> <ul style="list-style-type: none"> <li>- For the contents of setting, refer to c) of [Creation] above.</li> <li>- For selection of the RS-232C on the SIMATIC Series PLCs, refer to e) of [Creation] above.</li> </ul>	<p>The "Select Project" dialog box appears.</p> <p>The "System Environment" dialog box appears.</p>



Operation		Display (screen name)
	e)Set the following. Port : RS-232C Type : CPU (S7-200) DST Station No. : 1 to 31 GOT Station No. : 0 to 31 (S7-300) DST Station No. (Station No.) : 02 to 31 ("00" and "01" are treated as "02".) GOT Station No. (-) :-	
[Change method]	Change the connection type of the already created data as follows. a)Open GT Designer. b)Click the [Open] button. c)Open (read) the screen data to be changed. d)On the menu, select "Common"->"GOT/PLC Type". - For the contents of setting, refer to c) of [Creation] above. - For selection of the RS-232C on the SIMATIC Series PLCs, refer to e) of [Creation] above.	The "Select Project" dialog box appears.       The "GOT/PLC Type" dialog box appears.

11

Connection of MELSEC-Q Series PLC

12

Connection of FX Series Positioning

13

Connection of FREQROL Inverter

14

Connection of Microcomputer

15

Connection of SYSMAC C Series PLC

16

Connection of FLEX-PC N Series PLC

17

Connection of Machine Controller

18

Connection of FP Series PLC

19

Connection of SLC500 Series PLC

20

Connection of SIMATIC S7 Series PLC

#### 4) DU/WIN

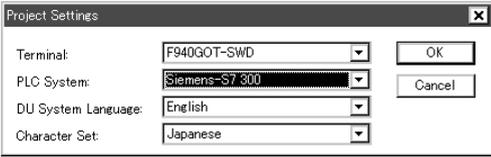
	Operation	Display (screen name)										
[Creation]	<p>a) Open DU/WIN.</p> <p>b) On the menu, select "File"-"New".</p>  <p>c) Set the following.</p> <p>Terminal: F940WGOT-TWD (V)(H)            F940GOT-LWD            F940GOT-SWD            F930GOT-BWD (V)(H)</p> <p>PLC System: Siemes-S7 300            Siemens-S7 200</p> <p>Select "Terminal" in accordance with the LC display color.</p> <table border="1" data-bbox="464 848 1134 1137"> <thead> <tr> <th>Terminal</th> <th>Model name</th> </tr> </thead> <tbody> <tr> <td>F940WGOT (V)(H)</td> <td>F940WGOT (color)</td> </tr> <tr> <td>F940GOT-LWD</td> <td>F940GOT (black and white) Handy GOT (black and white)</td> </tr> <tr> <td>F940GOT-SWD</td> <td>F940GOT (color) Handy GOT (color)</td> </tr> <tr> <td>F930GOT-BWD (V)(H)</td> <td>F930GOT-K (blue) F930GOT (blue)</td> </tr> </tbody> </table>	Terminal	Model name	F940WGOT (V)(H)	F940WGOT (color)	F940GOT-LWD	F940GOT (black and white) Handy GOT (black and white)	F940GOT-SWD	F940GOT (color) Handy GOT (color)	F930GOT-BWD (V)(H)	F930GOT-K (blue) F930GOT (blue)	<p>The "Project settings" dialog box appears.</p>
Terminal	Model name											
F940WGOT (V)(H)	F940WGOT (color)											
F940GOT-LWD	F940GOT (black and white) Handy GOT (black and white)											
F940GOT-SWD	F940GOT (color) Handy GOT (color)											
F930GOT-BWD (V)(H)	F930GOT-K (blue) F930GOT (blue)											

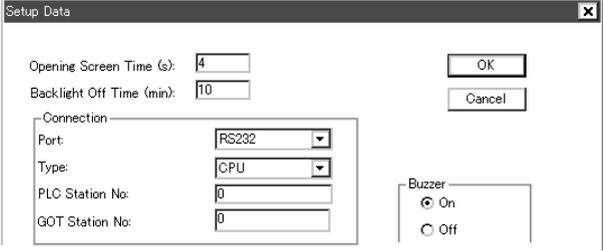
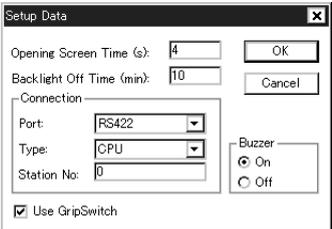
	Operation	Display (screen name)
	<p>d) Set CPU direct connection (RS-232C) of the GOT-F900. On the menu, select "View/Project"-&gt;"System Settings"-&gt;"Setup Data". &lt;In the case of version 2.52 or later&gt;</p>  <p>&lt;In the case of earlier than version 2.52&gt;</p>  <p>e) Set the following. Port: RS-232C Type: CPU (S7-200) DST Station No.: 1 to 31 GOT Station No.: 0 to 31 (S7-300) DST Station No. (Station No.): 02 to 31 ("00" and "01" are treated as "02".) GOT Station No. (-) :-</p>	<p>The "Setup Data" dialog box appears.</p>
[Change method]	<p>Change the connection type of the already created data as follows.</p> <p>a) Open DU/WIN. b) On the menu, select "File"-&gt;"Open". c) Select and open (read) the file of the screen data to be changed. d) When changing "Terminal" (GOT-F900), select "View/Project"-&gt;"System Settings"-&gt;"Project settings" on the menu. - For the contents of setting, refer to c) of [Creation] above. - For selection of the RS-232C on the SIMATIC Series PLCs, refer to e) of [Creation] above.</p>	<p>The "Open" dialog box appears.</p> <p>The "Project settings" dialog box appears.</p>

## 20.8 Cable Diagram

This section explains cable diagrams to connect the GOT-F900 and the SIMATIC S7-200/300/400 Series PLC manufactured by Siemens AG.

### 20.8.1 Cautions on preparing cables

When preparing the cables, use the wire size of 0.08mm<sup>2</sup> or more (AWG28 or more) for communication, 0.3mm<sup>2</sup> or more (AWG22 or more) for the power supply, operation switch, and emergency stop switch. Do not use a twisted pair cable with the power supply wire and the communication wire.

### 20.8.2 Cable diagram

#### 1) Cable for the GOT and the PLC manufactured by Siemens AG

 : Female type  : Male type The connector figure shows the engagement face.

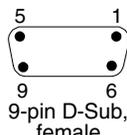
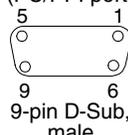
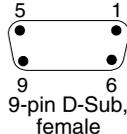
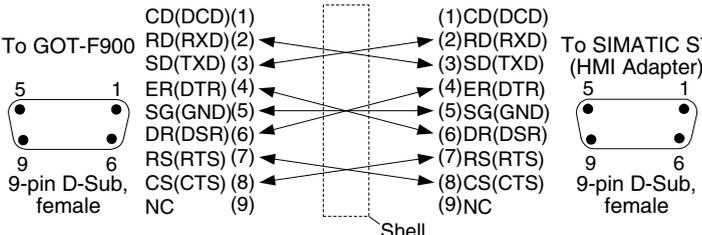
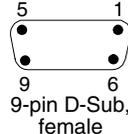
No.	Model name	Application	Connection diagram	Application
a)	<div style="border: 1px solid black; padding: 2px; display: inline-block;">RS-232C connection</div> <b>SIMATIC S7-200 Series</b> 6ES7 901-3BF20-0XA0 cable manufactured by Siemens AG	To GOT-F900  9-pin D-Sub, female	RS-232C ↔ RS-485	To SIMATIC S7 (PC/PPI port)  9-pin D-Sub, male
b)	<div style="border: 1px solid black; padding: 2px; display: inline-block;">RS-232C connection</div> <b>SIMATIC S7-300/400 Series</b> Prepared by the user 6ES7901-1BF00-0XA0 cable manufactured by Siemens AG is available also.	To GOT-F900  9-pin D-Sub, female		To SIMATIC S7 (HMI Adapter)  9-pin D-Sub, female

2) Cable for the F943 Handy GOT and the PLC manufactured by Siemens AG

When using the Handy GOT RH model, refer to the cable diagrams below for the RS-422/RS-232C connector, but not the wiring for the power supply, the operation switches, and the emergency stop switch because it is different. For details, refer to Section 5.18.

 : Female type  : Male type The connector figure shows the engagement face.

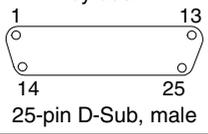
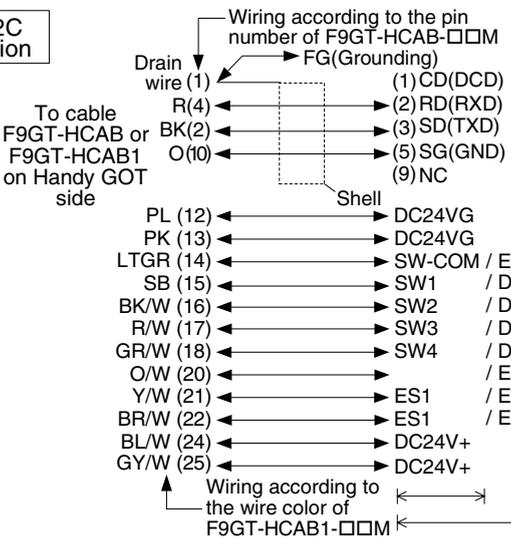
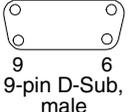
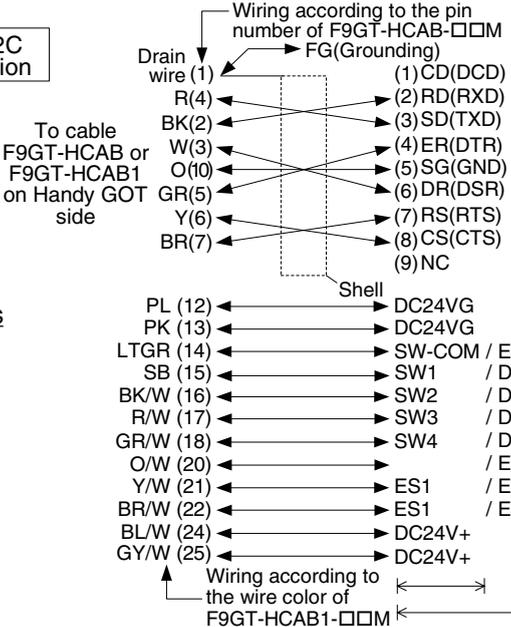
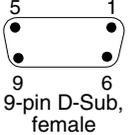
No.	Model name	Application	Connection diagram	Application
a)	F9GT-HCAB-3M F9GT-HCAB-10M	<div style="border: 1px solid black; padding: 2px; display: inline-block;">RS-422 connection</div> <div style="border: 1px solid black; padding: 2px; display: inline-block;">RS-232C connection</div> Dedicated connector on Handy GOT side	The connector on the leader side of the Handy GOT is dedicated, and cannot be prepared by the user.	To cable prepared by user  1 13 14 25 25-pin D-Sub, male
b)	F9GT-HCAB1-3M F9GT-HCAB1-10M	<div style="border: 1px solid black; padding: 2px; display: inline-block;">RS-422 connection</div> <div style="border: 1px solid black; padding: 2px; display: inline-block;">RS-232C connection</div> Dedicated connector on Handy GOT side	The connector on the leader side of the Handy GOT is dedicated, and cannot be prepared by the user.	Loose wires (no connector)
c)	SIMATIC S7-200 Series Prepared by the user	<div style="border: 1px solid black; padding: 2px; display: inline-block;">RS-232C connection</div>	<p>Wiring according to the pin number of F9GT-HCAB-□□□□</p>  <p>Wiring according to the wire color of F9GT-HCAB1-□□□□</p> <p>Old cable description  New cable description </p>	To 6ES7 901-3B F00-0XA0 (PC/PPI cable)  5 1 9 6 9-pin D-Sub, male  Wire the power supply, the operation switches and the emergency stop switch.
d)	SIMATIC S7-300/400 Series Prepared by the user	<div style="border: 1px solid black; padding: 2px; display: inline-block;">RS-232C connection</div>	<p>Wiring according to the pin number of F9GT-HCAB-□□□□</p>  <p>Wiring according to the wire color of F9GT-HCAB1-□□□□</p> <p>Old cable description  New cable description </p>	To SIMATIC S7 (HMI Adapter)  5 1 9 6 9-pin D-Sub, female  Wire the power supply, the operation switches and the emergency stop switch.

11 Connection of MELSEC-Q Series PLC  
12 Connection of FX Series Positioning  
13 Connection of FREQROL Inverter  
14 Connection of Microcomputer  
15 Connection of SYSMAC C Series PLC  
16 Connection of FLEX-PC N Series PLC  
17 Connection of Machine Controller  
18 Connection of FP Series PLC  
19 Connection of SLC500 Series PLC  
20 Connection of SIMATIC S7 Series PLC

## 20.9 Troubleshooting

For reference, this section summarizes frequently asked questions about connection of the GOT-F900 to the SIMATIC S7-200/300/400 Series PLC manufactured by Siemens AG.

### 1) GOT-F900

Contents of trouble	Check points and countermeasures	OS version		
		F940W	F940	F930
"COMMUNICATION ERROR OCCURS" is displayed when a screen changeover or numeric data input is performed on the GOT-F900 screen.	The power of the SIMATIC S7-200/300/400 Series PLC is turned off. <ul style="list-style-type: none"> <li>• Cause Communication is disabled because the power of the SIMATIC S7-200/300/400 Series PLC is turned off.</li> <li>• Countermeasures Turn on the power.</li> </ul>	From first product	From first product	From first product
	Something is wrong with the cable between the GOT-F900 and the SIMATIC S7-200/300/400 Series PLC. <ul style="list-style-type: none"> <li>• Causes The wrong cable is used or the connection is bad.</li> <li>• Countermeasures Check the cable.</li> </ul>			
"DISPLAY SCREEN IS NOT AVAILABLE." is displayed on the GOT-F900 screen.	Changeover to a nonexistent screen by a touch key or the SIMATIC S7-200/300/400 Series PLC was tried. <ul style="list-style-type: none"> <li>• Cause The changeover destination screen has not been created yet.</li> <li>• Countermeasures Create the screen.</li> </ul>	–	Earlier than 6.00	Earlier than 4.00
"DISPLAY SCREEN IS NOT AVAILABLE. (NO. ####)" is displayed on the GOT-F900 screen.	A nonexistent screen was tried to be displayed. <ul style="list-style-type: none"> <li>• Cause The screen No. #### has not been created yet.</li> <li>• Countermeasures Create the screen.</li> </ul>	From first product	6.00 or later	4.00 or later
"DISPLAY SCREEN IS NOT AVAILABLE." is displayed on the GOT-F900 screen.	A device that does not exist in the SIMATIC S7-200/300/400 Series is referenced. (Example: While an S300 is connected, a device exists only in the S400 is specified for numeric input.) <ul style="list-style-type: none"> <li>• Cause On the changeover destination screen (excluding the head screen), a nonexistent device in the connected SIMATIC S7-200/300/400 Series PLC is specified.</li> <li>• Countermeasures Check the devices used on the head screen.</li> </ul>	–	Earlier than 6.00	Earlier than 4.00
	There is an error on the screen to be displayed. <ul style="list-style-type: none"> <li>• Cause One of the screen objects is placed outside the available screen area.</li> <li>• Countermeasures Check the placement of screen objects.</li> </ul>			



Contents of trouble	Check points and countermeasures	OS version		
		F940W	F940	F930
"DISPLAY SCREEN IS NOT AVAILABLE. (NO. ####)" is displayed on the GOT-F900 screen.	<p>The display screen contains an error.</p> <ul style="list-style-type: none"> <li>Causes A device that does not exist in the connected PLC is referenced on the screen No. ####, or one of the screen objects is placed outside the available screen area.</li> <li>Countermeasures Check the devices used and placement of screen objects.</li> </ul>	From first product	6.00 or later	4.00 or later
"DATA IS NOT FOUND." is displayed on the GOT-F900 screen.	<p>There is not data because the unit is new or the memory clear has been executed.</p> <ul style="list-style-type: none"> <li>Cause There is no screen data.</li> <li>Countermeasures Write the screen data using the screen creation software.</li> </ul>	-	Earlier than 6.00	Earlier than 4.00
	<p>A device that does not exist in the SIMATIC S7-200/300/400 Series PLC was referenced. (Example: While an S300 is connected, a device exists only in the S200 is specified for numeric input.)</p> <ul style="list-style-type: none"> <li>Cause On the head screen, a nonexistent device in the connected SIMATIC S7-200/300/400 Series PLC is specified. (The head screen is the screen No. 1 in the GT Designer, and the screen No. 0 in the DU/WIN.)</li> <li>Countermeasures Check the devices used on the head screen.</li> </ul>			
	<p>There is not data because the unit is new or the memory clear has been executed.</p> <ul style="list-style-type: none"> <li>Cause There is no screen data.</li> <li>Countermeasures Write the screen data using the screen creation software.</li> </ul>	From first product	6.00 or later	4.00 or later
"CAN NOT WRITE TO PLC MEMORY." is displayed on the GOT-F900 screen.	This error is not displayed.	Earlier than 1.10	Earlier than 6.10	Earlier than 4.10
"CAN NOT WRITE." is displayed on the GOT-F900 screen.	This error is not displayed.	1.10 or later	6.10 or later	4.10 or later
"CAN NOT USE THE FUNCTION WHILE PROTECTED." is displayed on the GOT-F900 screen.	This error is not displayed.	From first product	From first product	From first product
"PLC IS RUNNING." is displayed on the GOT-F900 screen.	This error is not displayed.	From first product	From first product	From first product

11

Connection of MELSEC-Q Series PLC

12

Connection of FX Series Positioning

13

Connection of FREQROL Inverter

14

Connection of Microcomputer

15

Connection of SYSMAC C Series PLC

16

Connection of FLEX-PC N Series PLC

17

Connection of Machine Controller

18

Connection of FP Series PLC

19

Connection of SLC500 Series PLC

20

Connection of SIMATIC S7 Series PLC

2) Software

	Contents of trouble	Check points and countermeasures
Screen creation software	Communication with the screen creation software and screen data cannot be transferred.	<p>A SIMATIC S7-200/300/400 Series PLC, bar code reader or printer is connected.</p> <ul style="list-style-type: none"> <li>• Causes The RS-232C connector to which the personal computer is connected is set to be used for another piece of equipment.</li> <li>• Countermeasures In the GOT-F900, select by hand "SELECT MODE"- "OTHER MODE"- "DATA TRANSFER". Or set a bar code printer to invalid and a printer to "DON'T USE".</li> </ul>
		<p>Something is wrong with the cable between the GOT-F900 and the personal computer.</p> <ul style="list-style-type: none"> <li>• Causes The connected cable is not proper. Or cable connection is not correct.</li> <li>• Countermeasures Check the cable.</li> </ul>

## 21. Connection of Printer

This chapter explains the procedure to connect the GOT-F900 Series display unit to the printer. The printer cannot be used if another equipment is connected to the RS-232C port of the GOT-F900.

### Connection Procedure

This section introduces the procedure to connect the GOT-F900 to the printer.

#### 1. Preparation

Item name	Description	Reference
System Condition	You can learn the connection availability as well as the version of the GOT-F900 OS and the screen creation software.	21.1
System Configuration	You can select the configuration between the GOT and the printer and proper cables.	21.2

#### 2. Setting

Item name	Description	Reference					
Printer Communication Setting	<table border="1"> <tr> <td colspan="2">You can learn the communication specifications.</td> <td rowspan="2">21.3</td> </tr> <tr> <td>Transmission specifications and communication format</td> <td>The GOT communication specifications. Align the setting between the GOT and the printer.</td> </tr> </table>	You can learn the communication specifications.		21.3	Transmission specifications and communication format	The GOT communication specifications. Align the setting between the GOT and the printer.	
You can learn the communication specifications.		21.3					
Transmission specifications and communication format	The GOT communication specifications. Align the setting between the GOT and the printer.						
Cautions on Use of Printer	You can learn the cautions on connecting the personal computer while the printer is connected to the GOT.	21.4					
Setting of Connected Equipment for GOT	Set the communication specifications of the RS-232C port for the printer using the GOT or the screen creation software.	21.5					

#### 3. Others

Item name	Description	Reference
Cable Diagram	Cable diagrams for a printer/GOT connection	21.6

### 21.1 System Condition

When connecting the printer, check the COM port designation, the OS version of the GOT-F900, and applicable versions of the screen creation software.

Compatibility when connecting the printer

GOT-F900 Series	COM port		OS version of GOT-F900	Version of screen creation software		
	RS-422	RS-232C		GT Designer2	GT Designer	DU/WIN
F920GOT-K	–	–	–	–	–	–
F930GOT*1	–	✓*2	1.00	SW1-C	SW1-H	2.20
F930GOT-K*1	–	✓*2	4.60	SW1-C	SW5-26C	2.70
F940GOT	–	✓*2	1.00	SW1-C	SW1-A	2.00
F940WGOT	–	✓	1.00	SW1-C	SW5-F	2.50
F940 Handy GOT	–	–*3	1.00	SW1-C	SW1-D	2.10
F943 Handy GOT	–	–*3	1.00	SW1-C	SW1-D	2.10

- The screen creation software version corresponds to the model of the GOT-F900 Series.

\*1 Only the alarm history can be printed in the 930GOT, F933GOT and F930GOT-K. The sampling function and hard copy function are not available.

\*2 If the connector to be used on the connected PLC is RS-232C, a printer cannot be connected. If a printer is used to transfer screen data from PLC or in other modes, the same RS-232C connector is used. Therefore, the communication with printer is not possible.

\*3 The RS-232C port for the Handy type GOT is provided inside the rear cover. As a result, environmental protection is lost when using this port and such a connection is not practical.

## 21.2 System Configuration

The printer can be connected to the RS-232C port of the GOT-F900. This section explains the cable required to connect the printer.

### 21.2.1 Configuration for Printer Connection

Connect the GOT-F900 to the printer.

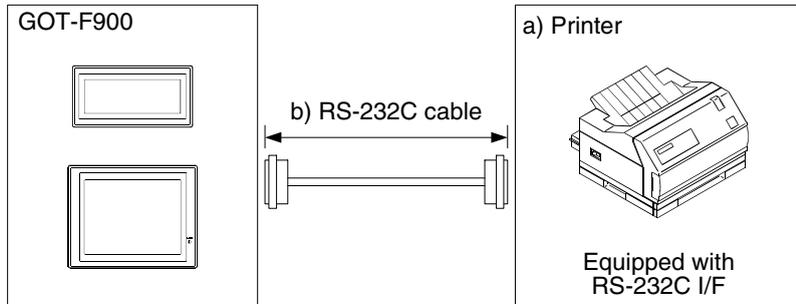

a) Printer		b) RS-232C cable
RS-232C port on printer side	25-pin D-Sub, male	Prepared by the user
	9-pin D-Sub, male	Prepared by the user

### 21.2.2 Applicable port on GOT-F900

The printer can be connected to a RS-232C port on the GOT-F900 if it is not occupied with the setting for other equipment such as a PLC, bar code reader or printer.

F940WGOT is equipped with the two RS-232C ports. Either port is applicable for connecting a printer.

## 21.3 Printer Communication Setting

When connecting the printer, the transmission specifications and the communication format described below should be satisfied in the printer.

### 21.3.1 Transmission Specifications and Communication Format

Set the transmission specifications and the communication format of the printer as shown in the table below.

#### 1) Applicable printer

The printer which can be connected via ESC/P (Epson Standard Code for Printer) control code and the RS-232C interface is applicable.

#### 2) Transmission specifications

Setting item			Communication setting (default value in [ ])	Remarks (Write set value of printer.)
GOT-F900	GT Designer	DU/WIN		
SPEED	Speed	Speed	[300],600,1200,2400,4800,9600	
DATA BIT	Data Bit	Databits	[7 bits],8 bits	
STOP BIT	Stop Bit	Stopbits	[1 bit],2 bits	
PARITY	Parity	Parity	[Even], Odd, None	
HANDSHAKING	Handshaking	Handshake	[DTR/DSR], XON/XOFF	
PRINTER	-	-	[DON'T USE], USE	Select "DON'T USE" except special cases.

- For the setting of "DON'T USE/USE" of the printer, refer to section 21.5.

### 3) Setting of "USE/DON'T USE"

In "SERIAL PORT (RS-232C)" in the GOT-F900, set "PRINTER" to "USE" or "DON'T USE".

When "PRINTER" is set to "DON'T USE", the RS-232C port of the GOT-F900 is automatically changed over in accordance with each communication. When "PRINTER" is set to "USE", only the printer is available.

(When the power is turned off once, then turned on again, the changed setting becomes valid.)

- Have in mind that screen data transfer, sequence program transfer or sequence program monitoring is disabled while "PRINTER" is set to "USE". For the details, refer to section 21.4.

21

Connection of  
Printer

22

Connection of  
Bar Code  
Reader

23

Appendix

## 21.4 Cautions on Use of Printer

When using the GOT-F900 connected to the printer, observe the following cautions on use.

### 21.4.1 Caution on printer setting

When "PRINTER" is set to "USE" in "SERIAL PORT(RS-232C)" in the GOT-F900, the RS-232C port of the GOT-F900 is occupied for the printer.

In this status, even if a personal computer is connected and screen data transfer or sequence program (two-port interface function) transfer/monitoring is executed, the GOT-F900 does not automatically change to the transfer screen. (And a communication error occurs in the application software installed in the personal computer.)

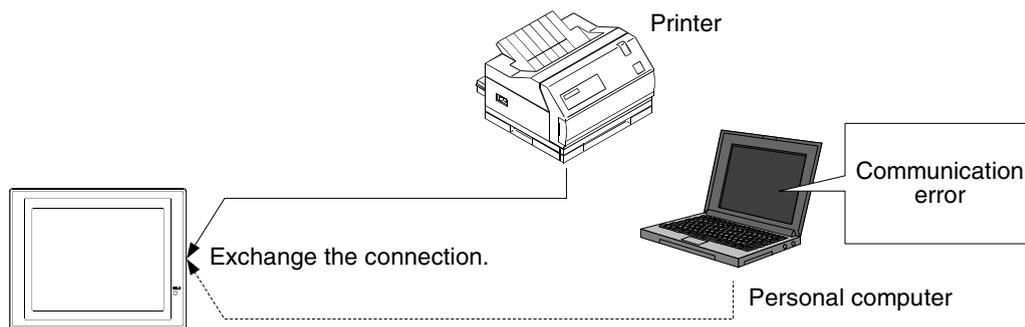

#### 1) Avoidance Method

When "PRINTER" is set to "USE", communication error can be avoided by executing an either operation.

Screen data transfer	Read and display the "SELECT MODE" screen, then select "OTHER MODE"- "DATA TRANSFER".
Sequence program transfer/monitoring	Set "PRINTER" to "DON'T USE", turn off the power, then turn it on again.

#### 2) Priority of the RS-232C Port Functions

From the functions having the highest priority, the system checks whether the setting is provided. If a certain function is set, functions having lower priority are disabled.

For example, when the PLC connection destination is set to RS-232C or when the bar code reader is set valid, functions having lower priority (such as screen data transfer and sequence program transfer/monitoring) are disabled.

Priority	RS-232C function
1	Connected equipment (PLC, general-purpose equipment)
2	Bar code reader
3	Printer
4	Two-port interface function *1
5	Screen data transfer mode

\*1 This function is valid only in CPU direct connection in the FX/A/QnA/Q Series. (This function is valid also in serial communication connection in the QnA/Q Series.)

When all communications should be valid, set "PRINTER" to "DON'T USE".

However, when the alarm history should be printed in real time at occurrence of alarms, "PRINTER" should be set to "USE".

### 21.4.2 Concurrent use of microcomputer and printer

When the microcomputer and the printer are used at the same time, the transmission specifications (such as the communication speed, the parity and the data length) are shared.

Accordingly, the transmission specifications should be equivalent between the microcomputer and the printer.

## 21.5 Setting of Connected Equipment for GOT

The setting for connection to the printer can be executed using the GOT-F900 and the screen creation software (GT Designer2, GT Designer or DU/WIN).

### 1) GOT-F900 Series

When the main menu screen change operation is disabled.

Operation	Display (screen name)
a) While pressing and holding the upper left corner of the screen, turn on the power. Keep holding the upper left corner for about 25 seconds more. Then, press "END" at the upper right corner.	The "LANGUAGE" screen appears.
b) Press "SERIAL PORT (RS-232C)".	The "SET-UP MODE" screen appears.
c) Set the transmission specifications for communication with the printer. Set "PRINTER" to "DON'T USE". For the available transmission specifications, refer to section 21.3.	The "SERIAL PORT" screen appears.

- When the screen data is transferred from screen creation software (GT Designer or DU/WIN) to the GOT-F900, the old data including the PLC type, connection type, and station number (excluding the printer status) are overwritten.

### 2) GT Designer2

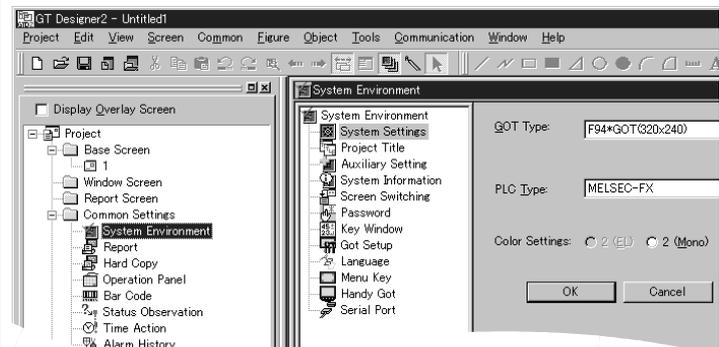
Operation	Display (screen name)
<p>[Creation]</p> <p>a) Open GT Designer2. b) Read the file of the screen data for which printer connection is to be set. c) Set the transmission specifications. On the menu, select "Common"-&gt;"System Environment".</p>  <p>Click "Auxiliary Setting" in the tree of the system environment menu. Click the check box of "Use Serial Port, Setup, Language, Menu Key" to give a check mark (✓). Click "Serial Port" in the tree of the system environment menu.</p>  <p>To "Speed", "Hand shaking", etc., set proper contents within the transmission specifications range for communication with the printer. After setting, click the [OK] button. For the available transmission specifications, refer to section 21.3.</p>	<p>The "Project Auxiliary Settings" dialog box appears.</p>

**3) GT Designer**

This setting is enabled to the SW4D5C-GOTR-PACKE version A or later.  
 In the case of SW4D5C-GOTR-PACKE earlier than version A, perform the setting in the GOT-F900.

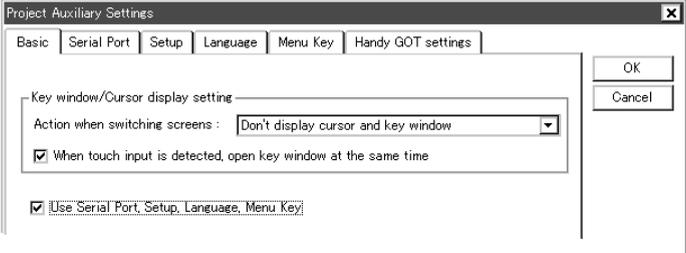
	Operation	Display (screen name)
[Creation]	<p>a) Open GT Designer.                      b) Read the file of the screen data for which printer connection is to be set.                      c) Set the transmission specifications.                      On the menu, select "Common"-&gt;"Auxiliary Settings"-&gt;"Project".</p>  <p>On the "Basic" tab, check "Use Serial Port, Setup, Language, Menu Key".                      Select the "Serial Port" tab.</p>  <p>To "Speed", "Hand shaking", etc., set proper contents within the transmission specifications range for communication with the printer.                      After setting, click the [OK] button.                      For the available transmission specifications, refer to section 21.3.</p>	<p>The "Project Auxiliary Settings" dialog box appears.</p>

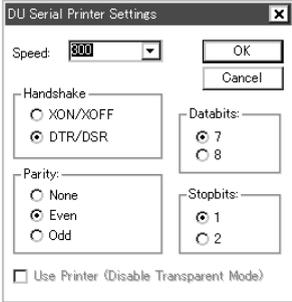

4) DU/WIN

Operation		Display (screen name)
<p>[Creation]</p> <p>For selection of RS-232C/RS-422, refer to e) in [Creation] above.</p>	<p>a) Open DU/WIN.                      b) Read the file of the screen data for which printer connection is to be set.                      c) Set the transmission specifications.                      Select "View/Project"-&gt;"System Settings"-&gt;"DU Printer" on the menu.</p>  <p>Set properly "Speed", "Handshake", etc., within the transmission specifications range for communication with the printer.                      After setting, click the [OK] button.                      For the available transmission specifications, refer to section 21.3.</p>	<p>The "DU Printer Settings" dialog box appears.</p>

21.6 Cable Diagram

This section explains a cable diagrams to connect the GOT-F900 and the printer (equipped with the RS-232C interface).

21.6.1 Cautions on preparing cables

When preparing the cables, use the wire size of 0.08mm<sup>2</sup> or more (AWG28 or more) for communication, 0.3mm<sup>2</sup> or more (AWG22 or more) for the power supply, operation switch, and emergency stop switch. Do not use a twisted pair cable with the power supply wire and the communication wire.

21.6.2 Cable diagram

1) Cable for the GOT and the printer

 : Female type  : Male type The connector figure shows the engagement face.

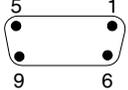
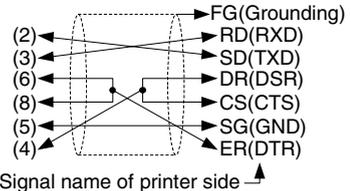
No.	Model name	Application	Connection diagram	Application
a)	Prepared by the user	To GOT-F900  9-pin D-Sub, female		To printer

# MEMO

## 22. Connection of Bar Code Reader

This chapter explains the procedure to connect the GOT-F900 Series display unit to the bar code reader. If equipment such as PLC or printer is connected to the RS-232C port of the GOT-F900, the bar code reader cannot be connected.

### Connection Procedure

This section introduces the procedure to connect the GOT-F900 to the bar code reader.

#### 1. Preparation

Item name	Description	Reference
System Condition	You can learn the connection availability as well as the version of the GOT-F900 OS and the screen creation software.	22.1
Connection Configuration	You can select the configuration between the GOT and the bar code reader and proper cables.	22.2

#### 2. Setting

Item name	Description	Reference												
Bar Code Reader Communication Setting	<table border="1"> <tr> <td>Transmission Specifications and Communication Format</td> <td>The communication specifications and the format of the GOT. Align the setting in the bar code reader with the setting in the GOT.</td> <td>22.3.1</td> </tr> <tr> <td>Bar Code Reader Control Devices</td> <td>Functions of control devices of the bar code reader.</td> <td>22.3.2</td> </tr> <tr> <td>Bar Code Data Setting</td> <td>Rules on how the bar code data read by the bar code reader is stored.</td> <td>22.3.3</td> </tr> <tr> <td>Sequence Program Example</td> <td>The outline of the sequence program.</td> <td>22.3.4</td> </tr> </table>	Transmission Specifications and Communication Format	The communication specifications and the format of the GOT. Align the setting in the bar code reader with the setting in the GOT.	22.3.1	Bar Code Reader Control Devices	Functions of control devices of the bar code reader.	22.3.2	Bar Code Data Setting	Rules on how the bar code data read by the bar code reader is stored.	22.3.3	Sequence Program Example	The outline of the sequence program.	22.3.4	22.3
	Transmission Specifications and Communication Format	The communication specifications and the format of the GOT. Align the setting in the bar code reader with the setting in the GOT.	22.3.1											
	Bar Code Reader Control Devices	Functions of control devices of the bar code reader.	22.3.2											
	Bar Code Data Setting	Rules on how the bar code data read by the bar code reader is stored.	22.3.3											
Sequence Program Example	The outline of the sequence program.	22.3.4												
Caution on Use of Bar Code Reader	You can learn the cautions on connecting the personal computer while the bar code reader is connected.	22.4												
Setting of Connected Equipment for GOT	Set the devices used in communication with the PLC using the screen creation software.	22.5												

#### 3. Others

Item name	Description	Reference
Cable Diagram	Cable diagrams for bar code reader/GOT connection	22.6
Troubleshooting	Description of errors and how to fix them	22.7

## 22.1 System Condition

When connecting the bar code reader, check the COM port designation, the OS version of the GOT-F900, and applicable versions of the screen creation software.

While the screen data is transferred from a personal computer or a printer is used in another mode in the GOT, the communication with a bar code reader is disabled because the RS-232C port is already occupied.

Compatibility when connecting the bar code reader

GOT-F900 Series	COM port		OS version of GOT-F900	Version of screen creation software		
	RS-422	RS-232C		GT Designer2	GT Designer	DU/WIN
F920GOT-K	-	-	-	-	-	-
F930GOT	-	✓ <sup>*1</sup>	2.00	SW1-C	SW1-H	2.30
F930GOT-K	-	✓ <sup>*1</sup>	4.60	SW1-C	SW5-26C	2.70
F940GOT	-	✓ <sup>*1</sup>	2.00	SW1-C	SW1-H	2.20
F940WGOT	-	✓	1.00	SW1-C	SW5-F	2.50
F940 Handy GOT	-	- <sup>*2</sup>	2.00	SW1-C	SW1-H	2.20
F943 Handy GOT	-	- <sup>*2</sup>	2.00	SW1-C	SW1-H	2.20

\*1 If the connector to be used on the connected PLC is RS-232C, a printer cannot be connected. if a printer is used to transfer screen data from PLC or in other modes, the same RS-232C connector is used. Therefore, the communication with printer is not possible.

\*2 The RS-232C port for the Handy type GOT is provided inside the rear cover. As a result, environmental protection is lost when using this port and such a connection is not practical.

## 22.2 Connection Configuration

The bar code reader can be connected to the RS-232C port of the GOT-F900. This section explains the cable and the option required for connection.

### 22.2.1 Configuration for Bar Code Reader Connection

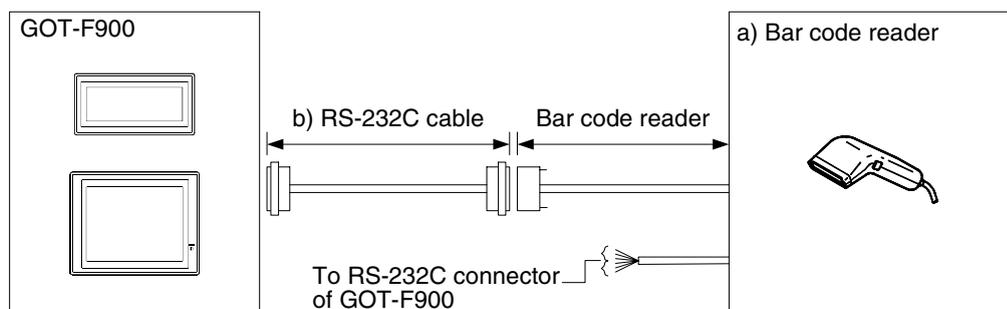

a) Bar code reader	b) RS-232C cable
Check the shape at end of cable of bar code reader used.	Prepared by the user

## 22.3 Bar Code Reader Communication Setting

The GOT can be connected to a bar code reader which satisfies the transmission specifications and the communication format shown below.

### 22.3.1 Transmission Specifications and Communication Format

Set the transmission specifications and the communication format of the bar code reader as shown in the table below. For the setting method, refer to the manual of the bar code reader.

#### 1) Transmission Specifications

Item	Set value	Remarks
Transmission speed	9600 bps	
Data format	Data bit	8 bits
	Parity bit	Provided (even)
	Stop bit	1 bit

- The transmission specifications and the communication format are fixed on the GOT-F900 side, and cannot be changed. Align the settings in the bar code reader with the settings in the GOT-F900.

#### 2) Communication Format

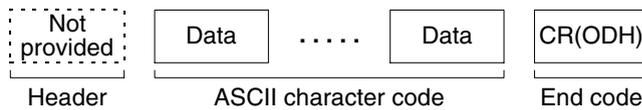

### 22.3.2 Bar Code Reader Control Devices

The information on the bar code reader communication status and bar code input start can be controlled from the connected equipment (such as PLC).

Set devices used to control the bar code reader using the screen creation software. This section describes assignment of devices set by the screen creation software and their functions.

#### 1) Device Assignment

a) In the case of screen creation software GT Designer2

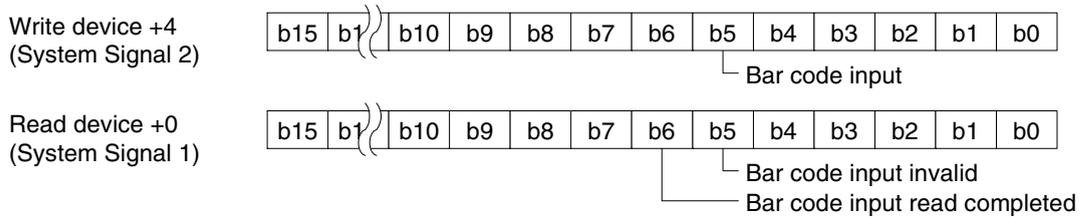

For the DU/WIN screen data

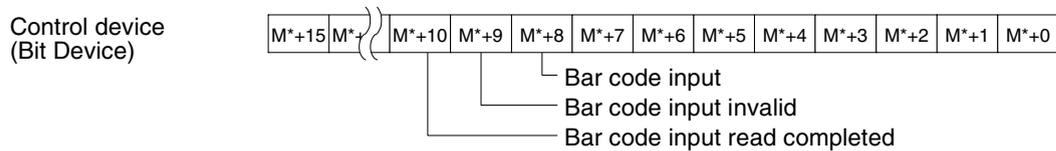

Signal name	GT Designer2 System information	DU/WIN Control device	Data direction
Bar code input	b5 of head write device +4	M*+8	GOT → Connected equipment
Bar code input invalid	b5 of head read device +0	M*+9	GOT ← Connected equipment
Bar code input read completed	b6 of head read device +0	M*+10	GOT ← Connected equipment

- For the method to assign control devices, refer to Section 22.5.

b) In the case of screen creation software GT Designer

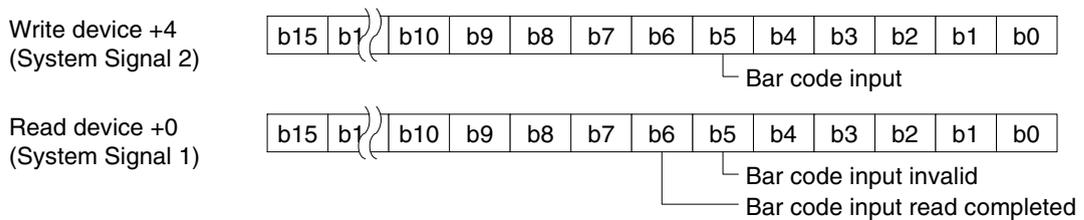

Signal name	GT Designer System information	Data direction
Bar code input	b5 of head write device +4	GOT → Connected equipment
Bar code input invalid	b5 of head read device +0	GOT ← Connected equipment
Bar code input read completed	b6 of head read device +0	GOT ← Connected equipment

- For the method to assign control devices, refer to Section 22.5.

c) For the DU/WIN screen data

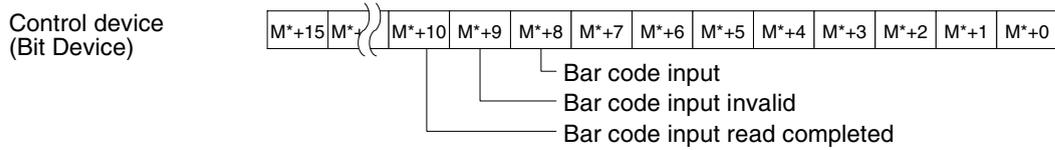

Signal name	DU/WIN Control device	Data direction
Bar code input	M*+8	GOT → Connected equipment
Bar code input invalid	M*+9	GOT ← Connected equipment
Bar code input read completed	M*+10	GOT ← Connected equipment

- For the method to assign control devices, refer to Section 22.5.

2) Signal Functions

Signal name	
Bar code input	Because this signal becomes ON when the data read by the bar code reader is stored in the PLC, the write timing can be confirmed using this signal. In order to set this signal to OFF, set to ON the bar code input read completed signal.
Bar code input invalid	When this bit becomes ON after a bar code input, the bar code input becomes invalid. The data read by the GOT-F900 is cleared.
Bar code input read completed	This signal sets the bar code input signal from ON to OFF.

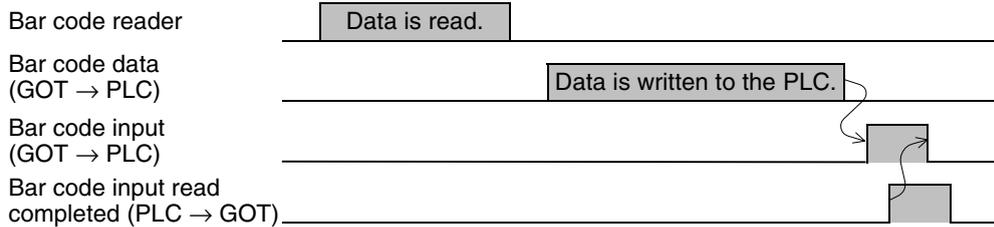

In either of the following conditions, the data read by the bar code reader is not written to the PLC.  
 When the bar code input invalid signal is ON  
 When the bar code input read completed signal remains ON.  
 When the bar code input signal is ON

### 22.3.3 Bar Code Data Setting

The bar code data read by the bar code reader is written from the GOT-F900 to the connected equipment (PLC).

Set word device to be written to the connected equipment using "Bar Code Settings" in the screen creation software.

Setting item	Description
Word device	Specify the head word device to be written to the connected equipment. (Excluding C200 to C255 (32 bits) high speed counter of FX Series PLC) For the device range specifications, refer to section 3.3.
Number of devices (word device quantity specification)	Specify the number of word devices. One word (one point) stores 2 characters of the ASCII code data transmitted from the bar code reader. The allowable setting range is from 2 to 32 points. (The head device stores the number of data, ASCII code data, read from the bar code reader.)

#### 1) Rules of Data Storage

The data is stored in the ASCII code format in word devices in the ascending order of the word device number. If the read data is larger than the specified number of devices, the excessive data is cut off. If the read data is smaller than the specified number of devices, space characters (20H) are provided in vacant devices.

a) When the number of data read from the bar code reader is equivalent to or less than the specified number of devices

Data read from the bar code reader: 1234567

Write destination device: D100

Number of devices: 6

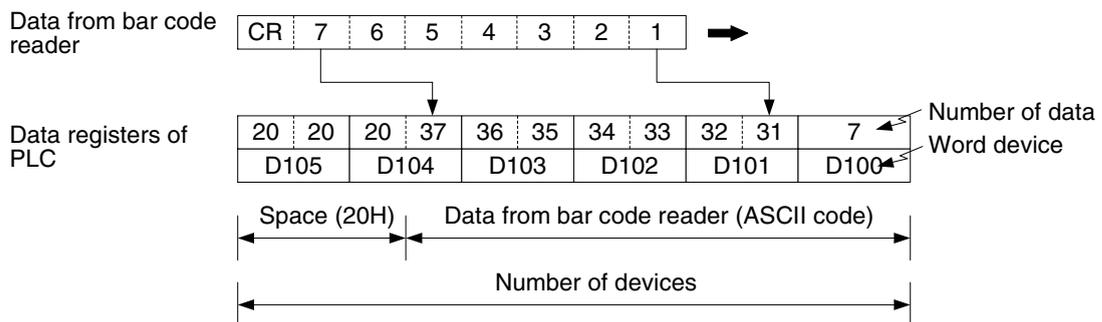

b) When the number of data read from the bar code reader is larger than the specified number of devices

Data read from the bar code reader: 1234567

Write destination device: D100

Number of devices: 2

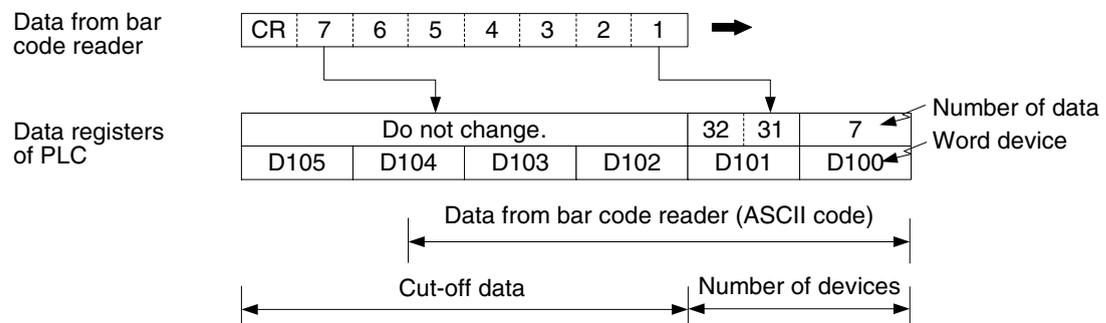

If the read data exceeds the specified number of devices, the excessive portion is not stored but cut off. D100 stores all the numbers of data including the excessive portion. Check D100 to see whether the data is correctly written.

The specified head word device stores all the numbers of data without regard to the specified number of devices.



### 22.3.4 Sequence Program Example

This section explains a program when the screen data is created using the GT Designer.

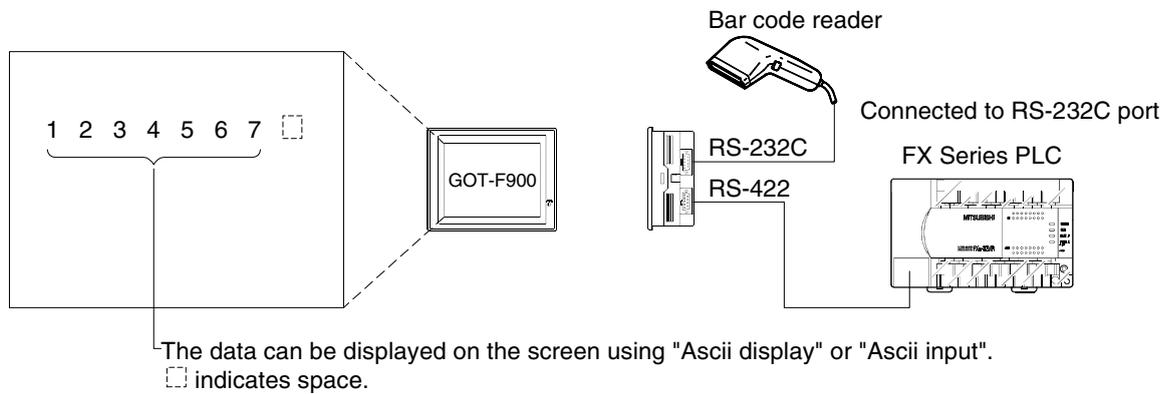

#### 1) Occupied device

- a) System Information Setting
  - Read device: D10 (b5 and b6 are occupied.)
  - Write device: D20 (D24 b5 is occupied.)
- b) Bar Code Setting (write destination device and number of devices)
  - Write destination device: D50
  - Number of devices: 5 (D50 to D54 are occupied.)
- c) Other setting
  - M15: Bar code input invalid
  - M16: Read of bar code input complete

#### 2) Program example

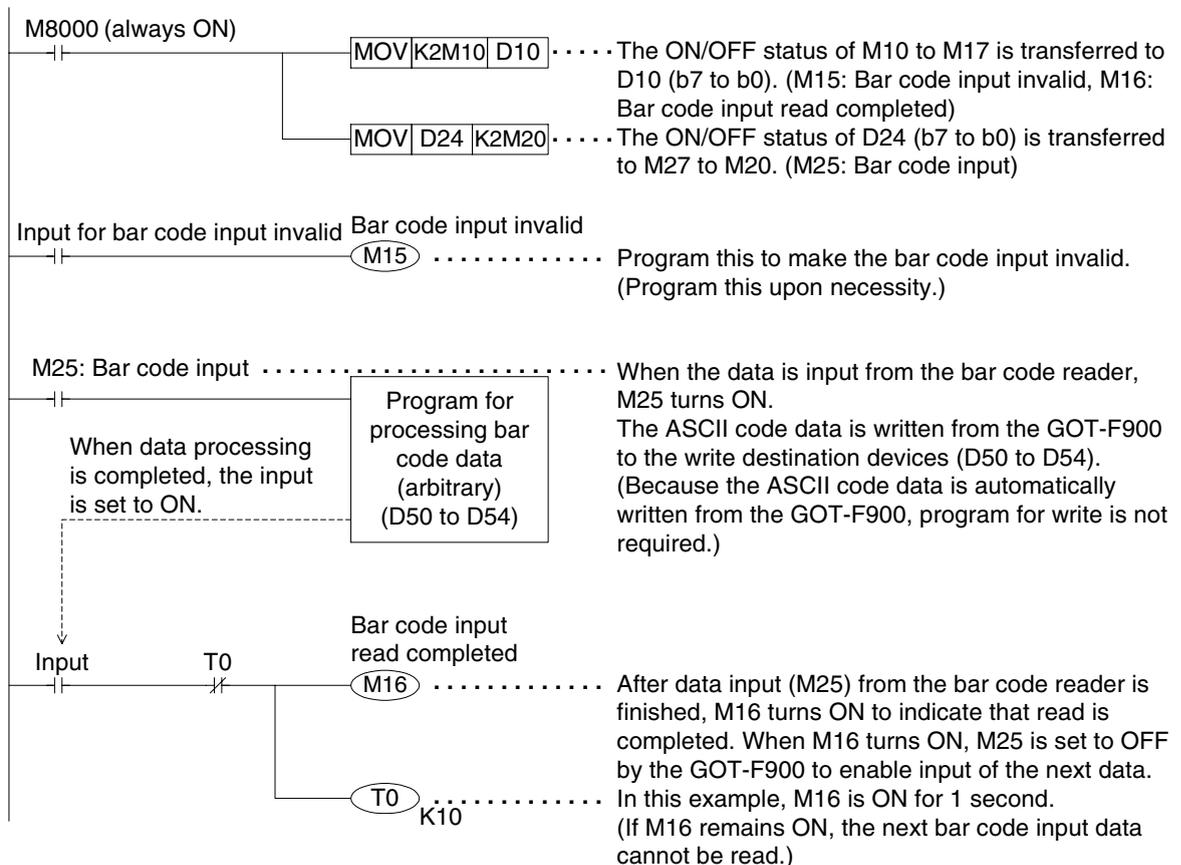

## 22.4 Caution on Use of Bar Code Reader

When using the bar code reader connected to the GOT-F900, observe the following cautions on use.

### 22.4.1 Caution on bar code reader setting

When "Bar code reader" is set to "USE" in the GOT-F900, the RS-232C port of the GOT-F900 is occupied by the bar code reader.

In this status, even if a personal computer is connected and screen data transfer or sequence program (two-port interface function) transfer/monitoring is tried, the GOT-F900 does not automatically change to the transfer screen. (And a communication error occurs in the application software installed in the personal computer.)

In the F940WGOT, refer to the description below when two RS-232C ports are used (to connect the PLC, the bar code reader, etc.).

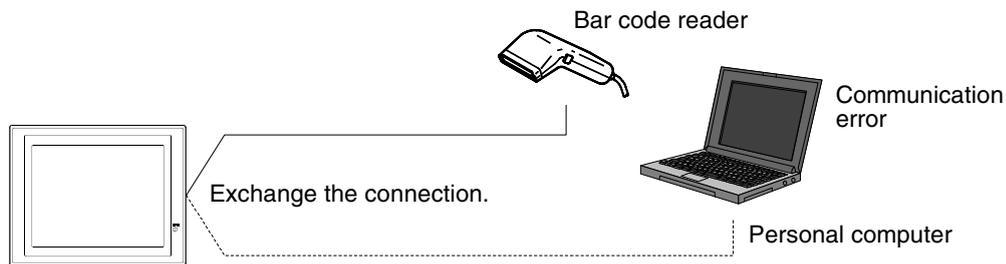

#### 1) Avoidance Method

When "Bar code reader" is set to "USE", communication error can be avoided by executing an either operation.

Screen data transfer	Read and display the "SELECT MODE" screen, then select "OTHER MODE"- "DATA TRANSFER".
Sequence program transfer/monitoring	Set "Bar code reader" to "DON'T USE".

#### 2) Priority of the RS-232C Port Functions

From the functions having the highest priority, the system checks whether the setting is provided. If a certain function is set, functions having lower priority are disabled.

For example, when the PLC connection destination is set to RS-232C or when the bar code reader is set valid, functions having lower priority (such as data transfer and sequence program transfer/monitoring) are disabled.

Priority	RS-232C function
1	Connected equipment (PLC, general-purpose equipment)
2	Bar code reader
3	Printer
4	Two-port interface function *1
5	Screen data transfer mode

\*1 This function is available only in CPU direct connection in the FX/A/QnA/Q Series. (This function is available also in serial communication connection in the QnA/Q Series.)

## 22.5 Setting of Connected Equipment for GOT

The setting for connection to the bar code reader can be executed using the screen creation software (GT Designer2, GT Designer or DU/WIN).

### 1) GOT-F900 Series

Connection of the bar code reader cannot be set in the GOT-F900 Series units.

### 2) GT Designer2

	Operation	Display (screen name)
[Setting method]	a) Open GT Designer.	
[System information]	b) Read the file of the screen data for which bar code reader connection is to be set. c) Set the write device and the read device. On the menu, select "Common"->"System Settings". Click "System Information" in the tree of the system environment menu. Set "Read Device" and "Write Device" inside the word device range of the connected equipment. After setting, click the [OK] button.	The "System Information" dialog box appears.
[Bar code setting]	d) Set the head device and the number of devices (default value: 2) to which the data read by the bar code reader is transferred (GOT-F900 → connected equipment). On the menu, select "Common"->"Barcode" or on the work space tree, select "Barcode". Set "Device" and "Device points". After setting, click the [OK] button.	The "Bar Code Settings" dialog box appears.

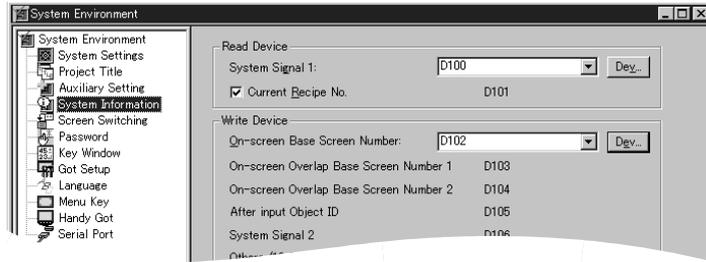

For the word device range specifications, refer to section 3.3.

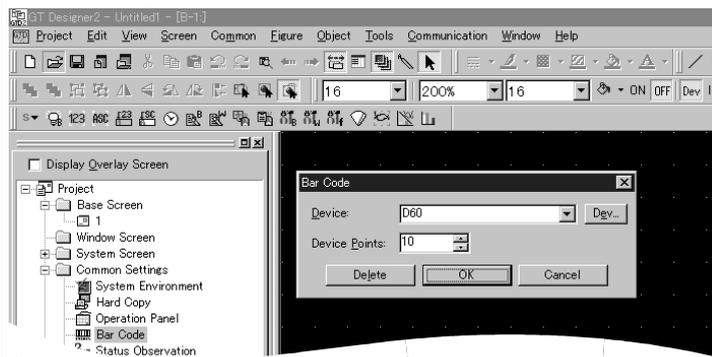

For the word device range specifications, refer to section 3.3.

3) GT Designer

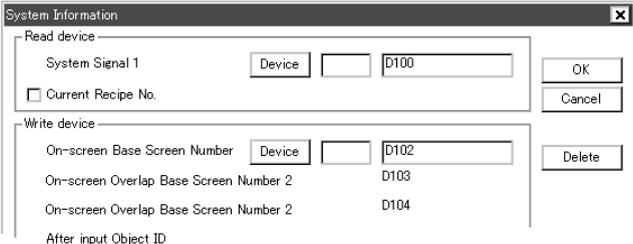
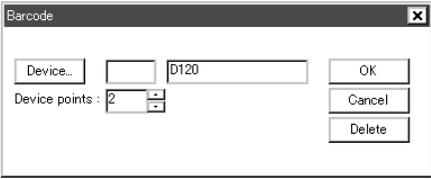
	Operation	Display (screen name)
<p>[Setting method]</p> <p>[System information]</p>	<p>a) Open GT Designer.</p> <p>b) Read the file of the screen data for which bar code reader connection is to be set.</p> <p>c) Set the write device and the read device.                      On the menu, select "Common"-&gt;"System Information".                      Set "Read device" and "Write device" inside the word device range of the connected equipment.                      After setting, click the [OK] button.</p>  <p>For the word device range specifications, refer to section 3.3.</p>	<p>The "System Information" dialog box appears.</p>
<p>[Bar code setting]</p>	<p>d) Set the head device and the number of devices (default value: 2) to which the data read by the bar code reader is transferred (GOT-F900 → connected equipment).                      On the menu, select "Common"-&gt;"Barcode". Set "Device" and "Device points".                      After setting, click the [OK] button.</p>  <p>For the word device range specifications, refer to section 3.3.</p>	<p>The "Bar Code Settings" dialog box appears.</p>

4) DU/WIN

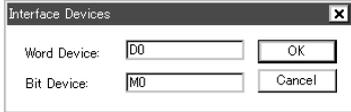
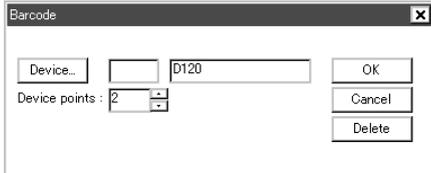
Operation		Display (screen name)
[Setting method]	<p>a) Open DU/WIN.</p> <p>b) Read the file of the screen data for which bar code reader connection is to be set.</p>	
[Control device]	<p>c) Set the control devices.</p> <p>On the menu, select "View/Project"-&gt;"System Settings"-&gt;"Interface Devices".</p> <p>Set "Word Device" and "Bit Device" inside the device range of the connected equipment.</p> <p>After setting, click the [OK] button.</p>  <p>For the word device range specifications, refer to section 3.3.</p>	<p>The "Interface Devices" dialog box appears.</p>
[Bar code setting]	<p>d) Set the head device and the number of devices (default value: 2) to which the data read by the bar code reader is transferred (GOT-F900 → connected equipment).</p> <p>On the menu, select "View/Projects"-&gt;"System Settings"-&gt;"Bar Code Settings".</p> <p>Check "Device points", and set "Device" and "Device points".</p> <p>After setting, click the [OK] button.</p>  <p>For the word device range specifications, refer to chapter 3.3.</p>	<p>The "Bar Code Settings" dialog box appears.</p>

## 22.6 Cable Diagram

This section explains a cable diagram to connect the GOT-F900 and the bar code reader.

### 22.6.1 Cautions on preparing cables

When preparing the cables, use the wire size of 0.08mm<sup>2</sup> or more (AWG28 or more) for communication, 0.3mm<sup>2</sup> or more (AWG22 or more) for the power supply, operation switch, and emergency stop switch. Do not use a twisted pair cable with the power supply wire and the communication wire.

### 22.6.2 Cable diagram

#### 1) Cable for the GOT and the bar code reader

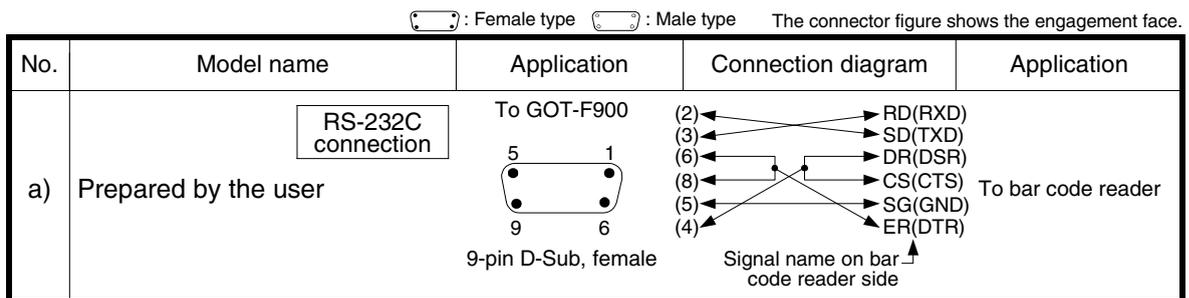

## 22.7 Troubleshooting

For reference, this section summarizes frequently asked questions about connection of the GOT-F900 to the FX Series PLC.

Contents of trouble	Check points and countermeasures
The data is not written to the PLC normally.	The data is not written to the PLC.  • Cause 1) The communication specifications are not satisfied. 2) Wrong wiring. 3) Either signal, the bar code input signal, the bar code input invalid signal or the bar code input read completed signal, assigned to the device (system information/control device) is ON.  • Countermeasures 1) Check the specification of the bar code reader. 2) Check the wiring between the GOT and the bar code reader. 3) Change the bar code input read completed signal to ON in the PLC, the GOT sets to OFF the bar code input signal.
	The data is partially written to the PLC (After receiving the end code (CR: 0DH) from the bar code reader, the GOT writes data to the PLC. Accordingly, it does not usually occur that data is partially written.)  • Cause 1) The number of devices may be small. 2) The bar code reader specifications are not satisfied. 3) The data may be interrupted while being transferred.  • Countermeasures 1) Check the setting of the bar code in the screen creation software. 2) Check the bar code reader specifications. 3) Check whether there is imperfect contact in such places as a connector.

## 23. Appendix

This chapter describes diversified technical information.

Backlight ON/OFF Status Control Method and Replacement Procedure .....	23.1
Battery Voltage Drop Detection Method and Replacement Procedure.....	23.2
Connection of Programming Tools via FX-2PIF .....	23.3
GOT-F900 Connector Signal Correspondence Table (Excluding the 5V type F920GOT-K.).....	23.4
Error Messages in GOT-F900 Series .....	23.5

21

Connection of  
Printer

22

Connection of  
Bar Code  
Reader

23

Appendix

## 23.1 Backlight ON/OFF Status Control Method and Replacement Procedure

The ON/OFF status of the backlight can be controlled using the setting in the screen creation software and sequence program.

### 23.1.1 Backlight Control Operation

The ON/OFF status of the backlight can be controlled using the following method.

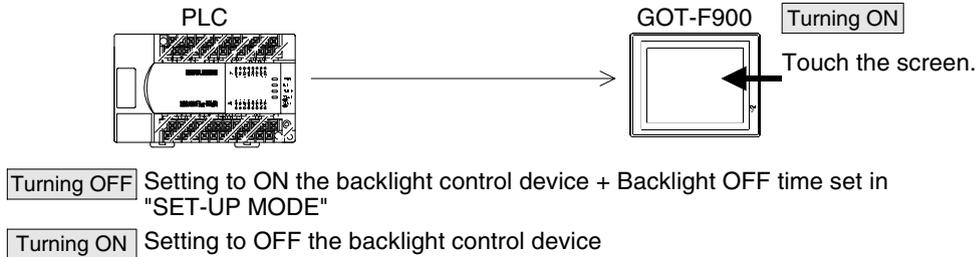

#### 1) Turning off the backlight

When the backlight control device is set to ON by a sequence program, the backlight will turn off after the OFF time set in "SET BACKLIGHT" in "SET-UP MODE" of the system menu of the GOT-F900.

#### 2) Turning on the backlight

The backlight turns on by either of the following operation.

- a) Setting to OFF the backlight control device by a sequence program
- b) Touching the screen of the GOT-F900
  - The entire screen functions as a touch switch to turn on the backlight.
  - In the F920GOT-K, press any switch on the keypad to turn on the backlight.



### 23.1.2 Assigning Device to Control ON/OFF Status of the Backlight

The backlight ON/OFF status can be controlled by setting to ON or OFF the backlight control device set in the screen creation software by a sequence program.

#### 1) In the case of screen creation software (GT Designer2)

- Operating procedure**
  - Tool menu**
    - Select "Common"->"System Environment".
    - Click "System Information" in the tree displayed on the "System Environment" dialog box, then set "Read Device".
  - Tree in the project work space**
    - Double-click "Common"->"System Environment".
    - Click "System Information" in the tree displayed on the "System Environment" dialog box, then set "Read Device".

In the sequence program example shown below, the read device is set to "D10".  
 D10 b1: Backlight control  
 (When this bit is set to ON, the backlight will turn off after the specified time.)

Read device (system signal 1)

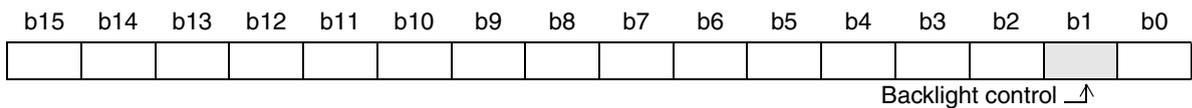

For the details of the system information, refer to the GOT-F900 OPERATION MANUAL (GT Designer2) or the manual of the screen creation software.

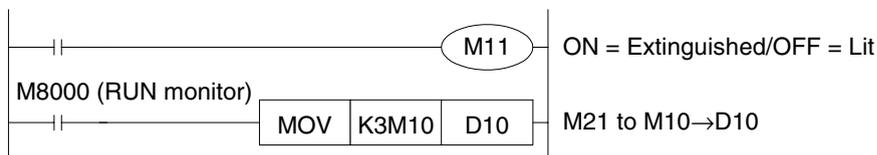

When a data file created using the DU/WIN is used (only in the GOT-F900) or when the data is read from the GOT-F900, execute the following procedure.

- Operating procedure**
  - Tool menu**
    - Select "Common"->"System Environment".
    - Click "Interface Device" in the tree displayed on the "System Environment" dialog box, then set "Bit Device".
  - Tree in the project work space**
    - Double-click "Common"->"System Environment".
    - Click "Interface Device" in the tree displayed on the "System Environment" dialog box, then set "Bit Device".

A sequence program example is equivalent to the example shown for the DU/WIN later.

**2) In the case of screen creation software (GT Designer)**

**Operating procedure** Tool menu

Select "Common"->"System Information", then set "Read Device".

In the sequence program example shown below, the read device is set to "D10".

D10 b1: Backlight control

(When this bit is set to ON, the backlight will turn off after the specified time.)

Read device +0

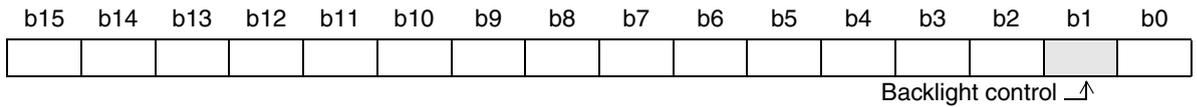

For the details of the system information, refer to the GOT-F900 OPERATION MANUAL (GT Designer and DU/WIN) or the manual of the screen creation software.

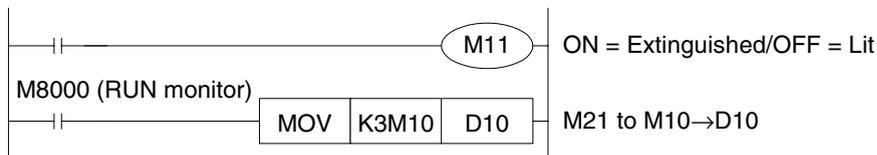

**3) In the case of screen creation software (DU/WIN)**

**Operating procedure** Tool menu

Select "View/Project"->"System settings"->"Interface Device", then set "Bit Device".

In the sequence program example shown below, the head control bit device No. is set to "M0".

M2: Backlight control (When this bit is set to ON, the backlight will turn off after the specified time.)

Bit device

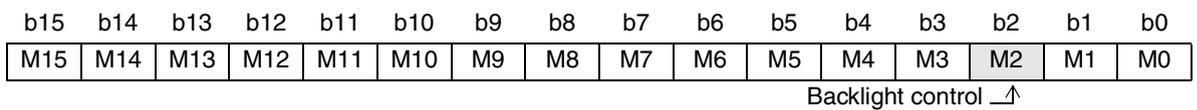

For the details of the control devices, refer to the GOT-F900 OPERATION MANUAL (GT Designer and DU/WIN) or the manual of the screen creation software.



### 23.1.3 Backlight Replacement Procedure

Replace the backlight (spare part) using the following procedure.

#### 1) F920GOT-K

The backlight is not required to be replaced because it is the LED type.

#### 2) F930GOT and F933GOT

- a) Turn off the power.
- b) While pressing claws at the four corners, move upward the rear cover.
- c) Disconnect the backlight connector.
- d) While pressing the claw of the backlight, move upward the backlight in the direction A by approximately 10mm (0.39").
- e) Pull out the backlight in the direction B, then install a new backlight.
- f) Accommodate the new backlight in the order "4)→3)→2)" which is reverse of the order above.

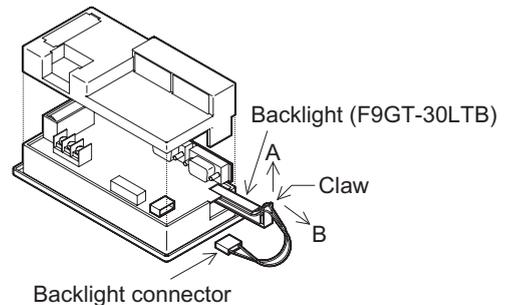

#### 3) F940GOT and F943GOT

- a) Turn off the power.
- b) Remove mounting screws at the four corners
- c) Slowly remove the rear cover.
 

Caution

If the rear cover is pulled with an excessive force, the cable connecting the rear cover may be disconnected, or the PCB may be damaged. Be careful.
- d) Disconnect the backlight connector.
- e) Remove the backlight F9GT-40LTS from the backlight fixing holder.
 

The backlight can be removed easily by inserting a screwdriver into the holder.
- f) Install a new backlight F9GT-40LTS.
- g) Accommodate the new backlight in the order "4)→3)→2)" which is reverse of the order above.

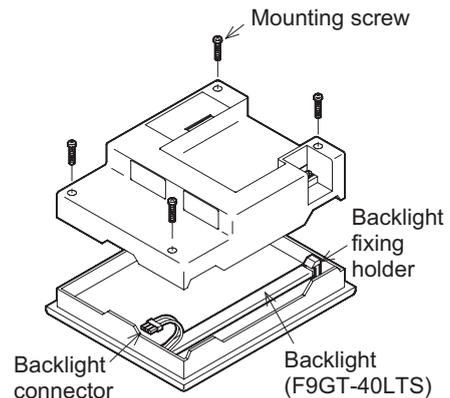

#### 4) F930GOT-K, F940WGOT and Handy GOT

For replacement of the backlight or the LCD, consult with the Mitsubishi distributor nearest to your company.

### 23.1.4 Cautions on Use of Backlight



#### 1) Touch switch operations when the backlight OFF function is set

Even if a touch switch is pressed while the backlight is OFF, the switch operation and screen switching are invalid. (When a touch switch is pressed, the backlight turns on.)

Once the backlight turns on, touch switches are valid.

#### 2) When the backlight is worn out

When the backlight of the GOT is worn out, the display area is completely dark and the monitor screen cannot be seen. However, touch switch inputs remain valid.

If the operator misunderstands the backlight worn-out status as the backlight OFF status and touches the display area, touch switches may operate.

If the backlight is worn out, the following phenomenon occurs in the GOT.

- Though the backlight OFF function is not set, the monitor screen blacks out.
- When the backlight OFF function is set, even if the display area is touched while the monitor screen is black, the monitor screen does not appear.

## 23.2 Battery Voltage Drop Detection Method and Replacement Procedure

In the GOT-F900, when the battery voltage drops, a part of the data saved in the RAM memory is deleted (becomes uncertain).

It is recommended to provide a lamp using the output of the PLC by setting the screen creation software as described below so that the battery voltage can be monitored from the outside.

### 23.2.1 RAM Data When Battery Voltage Drops

When the battery voltage drop detection device turns ON, immediately replace the battery using the following procedure. Even if the battery voltage drops, the RAM data remains held for approximately 1 month. After that, the RAM data cannot be held any more.

Function		F940GOT F940WGOT	Handy GOT	F930GOT F930GOT-K	F920GOT-K
Recipe data	Data set by screen creation software	Not held*1	Not held*1	Not held*1	Held*2
	Data set or changed by GOT-900	Not held	Not held	Not held	Held*2
Current time		Not held	Not held	Not held	--
Time action (time switch)	Data set by screen creation software	Not held*1	Not held*1	Not held*1	--
	Data set or changed by GOT-900	Not held	Not held	Not held	--
Alarm history data		Not held	Not held	Not held	Held*2
Sampling data		Not held	Not held	--	--
Operation environment setting	Data set by screen creation software	Not held*1	Not held*1	Not held*1	Held*2
	Data set or changed by GOT-900	Not held	Not held	Not held	Held*2

\*1 If the battery voltage drops and the data is deleted (becomes uncertain) while the power is OFF, the data is read from the flash memory when the power is turned on at the next time.

\*2 The data is stored in the EEPROM memory.

### 23.2.2 Built-in battery model name and life

Function	F940GOT F940WGOT	Handy GOT	F930GOT F930GOT-K	F920GOT-K
Battery model name	PM-20BL	FX2NC-32BL	FX2NC-32BL	No battery
Battery life	5 years	3 years	3 years	--

### 23.2.3 Assigning Device to Check Battery Voltage Drop

It is necessary to assign the device to monitor drop of the battery voltage of the GOT-F900 using the screen creation software.

#### 1) In the case of screen creation software (GT Designer2)

**Operating procedure**

Tool menu

Select "Common"->"System Environment".  
Click "System Information" in the tree displayed on the "System Environment" dialog box, then set "Write Device".

Tree in the project work space

Double-click "Common"->"System Environment".  
Click "System Information" in the tree displayed on the "System Environment" dialog box, then set "Write Device".

In the sequence program example shown below, the write device is set to "D20".  
D24 b3: Battery voltage drop detection (When the battery voltage drops, this bit turns ON.)

System signal 2

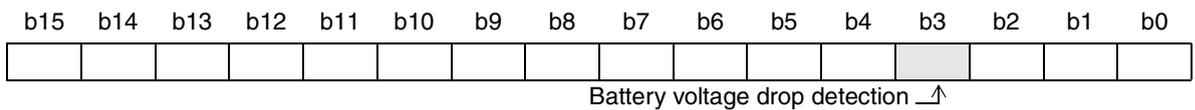

For the details of the system information, refer to the GOT-F900 OPERATION MANUAL (GT Designer2) or the manual of the screen creation software.

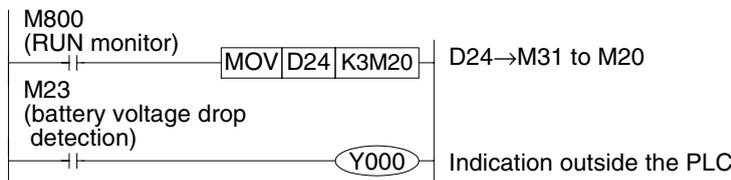

When a data file created using the DU/WIN is used (only in the GOT-F900) or when the data is read from the GOT-F900, execute the following procedure.

**Operating procedure**

Tool menu

Select "Common"->"System Environment".  
Click "Interface Device" in the tree displayed on the "System Environment" dialog box, then set "Bit Device".

Tree in the project work space

Double-click "Common"->"System Environment".  
Click "System Information" in the tree displayed on the "System Environment" dialog box, then set "Read Device".

A sequence program example is equivalent to the example shown for the DU/WIN later.

**2) In the case of screen creation software (GT Designer)**

Operating procedure Tool menu

Select "Common"->"System Information", then set "Write Device".

In the sequence program example shown below, the write device is set to "D20".  
D24 b3: Battery voltage drop detection (When the battery voltage drops, this bit turns ON.)

Write device +4 (System signal 2)

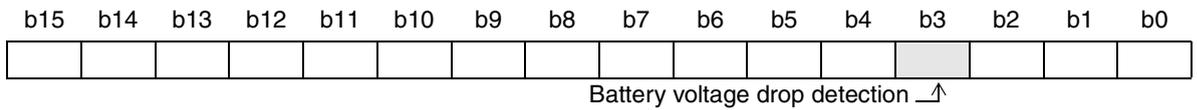

For the details of the system information, refer to the GOT-F900 OPERATION MANUAL (GT Designer and DU/WIN) or the manual of the screen creation software.

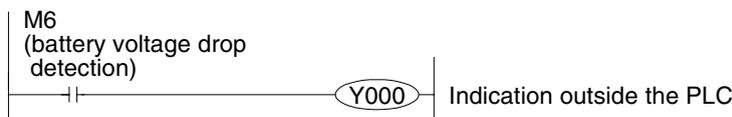

**3) In the case of screen creation software (DU/WIN)**

Operating procedure Tool menu

Select "View/Project"->"System settings"->"Interface Device", then set "Bit Device".

In the sequence program example shown below, the head control bit device No. is set to "M0".  
M6: Battery voltage drop detection (When the battery voltage drops, this bit turns ON.)

Bit device

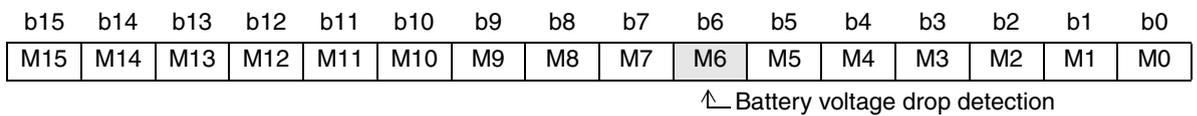

For the details of the control devices, refer to the GOT-F900 OPERATION MANUAL (GT Designer and DU/WIN) or the manual of the screen creation software.

### 23.2.4 Battery Replacement Procedure

When the battery voltage drop detection device turns ON, immediately replace the battery using the following replacement procedure.

#### 1) F920GOT-K

The backlight is not required to be replaced because it is not built in from the beginning (battery-less type).

#### 2) F930GOT, F933GOT and F930GOT-K

- a) Turn off the power.
- b) Remove the rear cover.
- c) Remove the existing battery from the holder, and disconnect its connector.
- d) Insert the connector of a new battery within 30 seconds.
- e) Insert the new battery into the holder, and attach the cover.

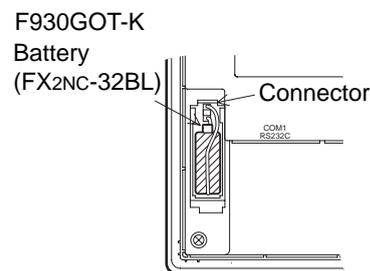
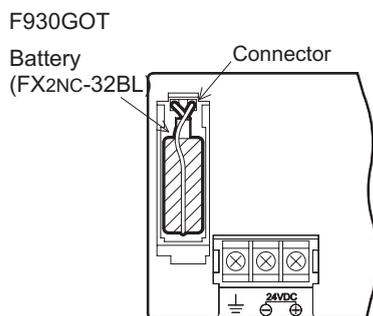

#### 3) F940GOT, F943GOT and F940WGOT

- a) Turn off the power.
- b) Open the small slot in the rear cover.
- c) Remove the existing battery from the holder, and disconnect its connector.
- d) Insert the connector of a new battery within 30 seconds.
- e) Insert the new battery into the holder, and close the small slot.

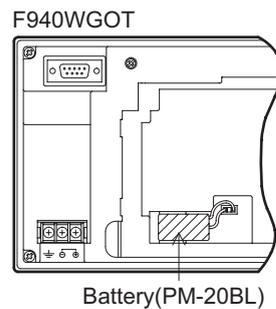
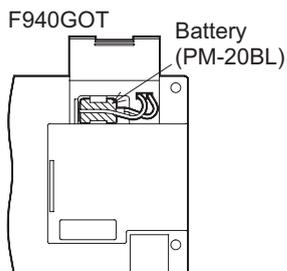



**4) Handy GOT**

- a) Turn off the power.
- b) Remove four mounting screws from the rear cover, then remove the rear cover.
- c) Remove the existing battery from the holder, and disconnect its connector.
- d) Insert the connector of a new battery within 30 seconds.
- e) Insert the new battery into the holder, and attach the cover.

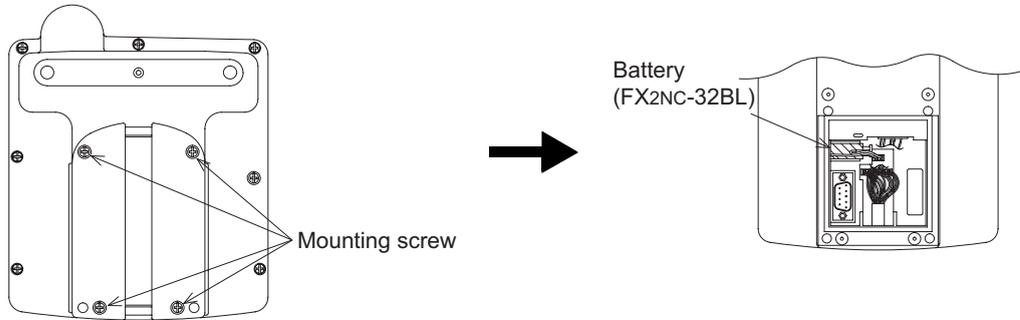

### 23.3 Connection of Programming Tools via FX-2PIF

#### 23.3.1 How to Monitor Using A6GPP/A7PHP/HPP

This section explains the connection method to execute program transfer/monitoring from the dedicated equipment for PLC programming (such as the A6GPP, the A7PHP, the FX-10P and the FX-20P) using the FX-2PIF two-port interface connected to the RS-422 port of the GOT-F900.

##### 1) Connection condition

Target model	Applicable PLC
F930GOT F930GOT-K F940GOT F940WGOT F940 Handy GOT	Only models equipped with RS-422 I/F  FX PLC direct connection A Series CPU direct connection

##### 2) F930GOT/F930GOT-K/F940GOT/F940WGOT

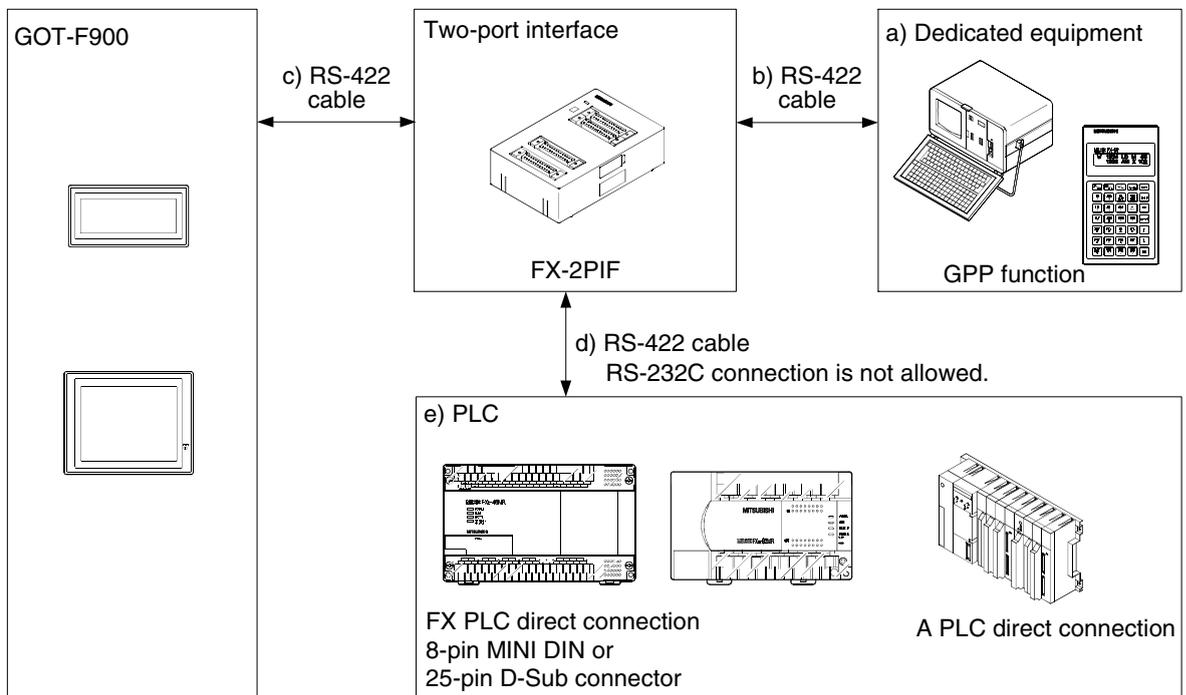

Cables for the dedicated equipment

a) Dedicated equipment	b) RS-422 cable
FX-10P, FX-20P	FX-20P-CAB
A6PHP, A6GPP, A7PHP, A7HGP	AC-30R4

Cables for the GOT-F900

c) RS-422 cable	e) Connectable PLC	d) RS-422 cable
FX-40DU-CAB	FX PLC direct connection (25-pin D-Sub)	FX-422CAB
FX-40DU-CAB-□□M	A Series CPU direct connection (25-pin D-Sub)	FX-422CAB-150
FX-50DU-CABL	FX PLC direct connection (8-pin MINI DIN)	FX-422CAB0

- "□□" indicates cable length.

- The right-angle type cable (FX-50DU-CABL) cannot be used for the F930GOT and F930GOT-K.

3) F940 Handy GOT

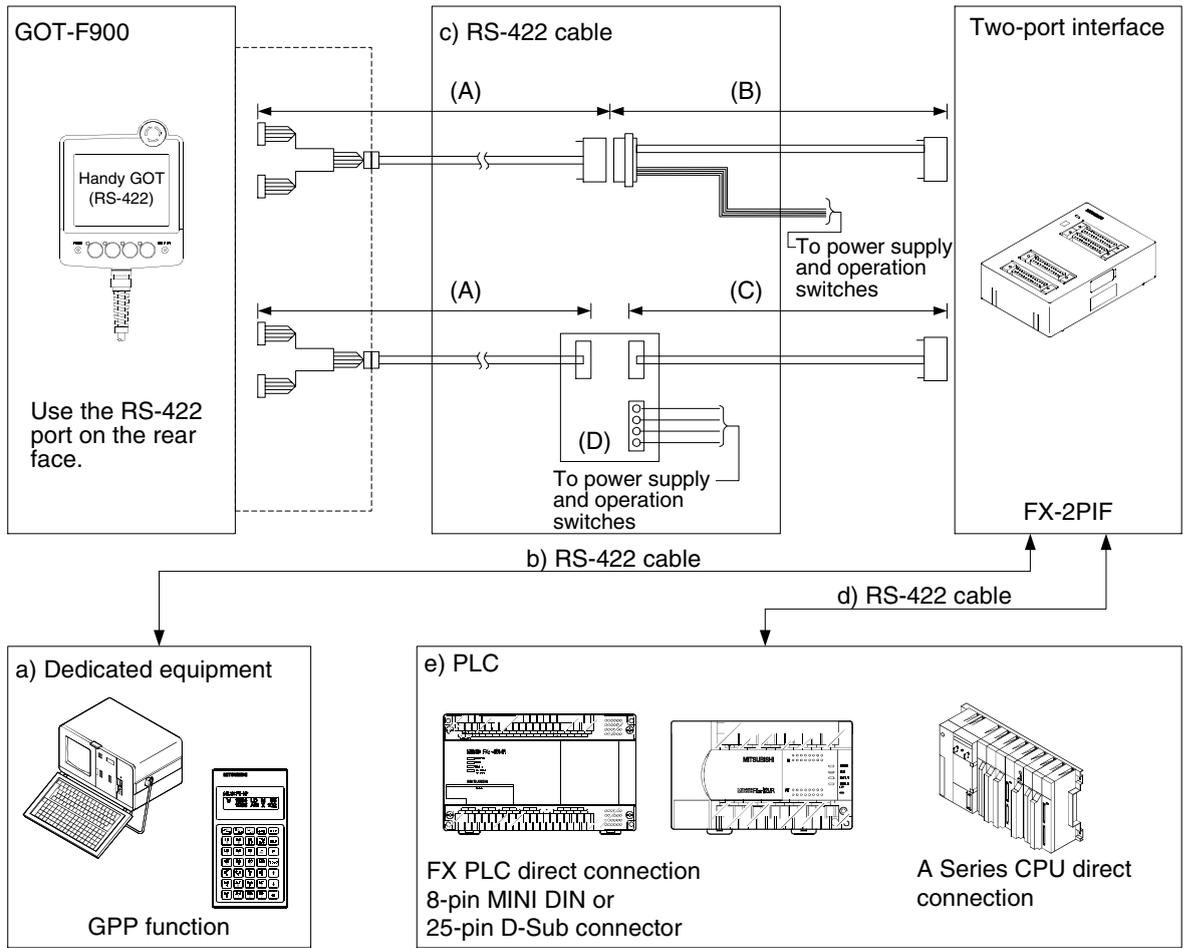

Cables for the dedicated equipment

a) Dedicated equipment	b) RS-422 cable
FX-10P, FX-20P	FX-20P-CAB
A6PHP, A6GPP, A7PHP, A7HGP	AC-30R4

Cables to the GOT-F900

c) RS-422 cable	e) PLC	d) RS-422 cable
(A)F9GT-HCAB-□□M	FX PLC direct connection (25-pin D-Sub)	FX-422CAB
(B)F9GT-HCAB3-150	A Series CPU direct connection (25-pin D-Sub)	FX-422CAB-150
(C)FX-40DU-CAB		
(D)F9GT-HCNB	FX PLC direct connection (8-pin MINI DIN)	FX-422CAB0

- "□□" indicates cable length.

### 23.3.2 Restrictions in Number of Devices Monitored When Using FX-2PIF

The table below shows the applicable PLC according to the versions of FX-2PIF. When using with an A Series PLC, there are restrictions in the quantity of data being monitored.

#### 1) System Condition

Applicable PLC		Versions of FX-2PIF	Applicable dedicated equipment
FX Series	FX0, FX0S, FX0N, FX1, FX2, FX2C	1.00 or later	FX-10P FX-20P
	FX2N, FX2NC	2.00 or later	
A Series	AnA, AnN, A2C	2.00 or later	GP-80 A6GPP/PHP A7PHP/HGP
	A1S, A0J2H	2.10 or later	
	AnU	2.20 or later	

- The applicable dedicated equipment above can be connected to FX-2PIF.

#### 2) Restrictions in the number of devices being monitored (only when the A Series PLC is connected)

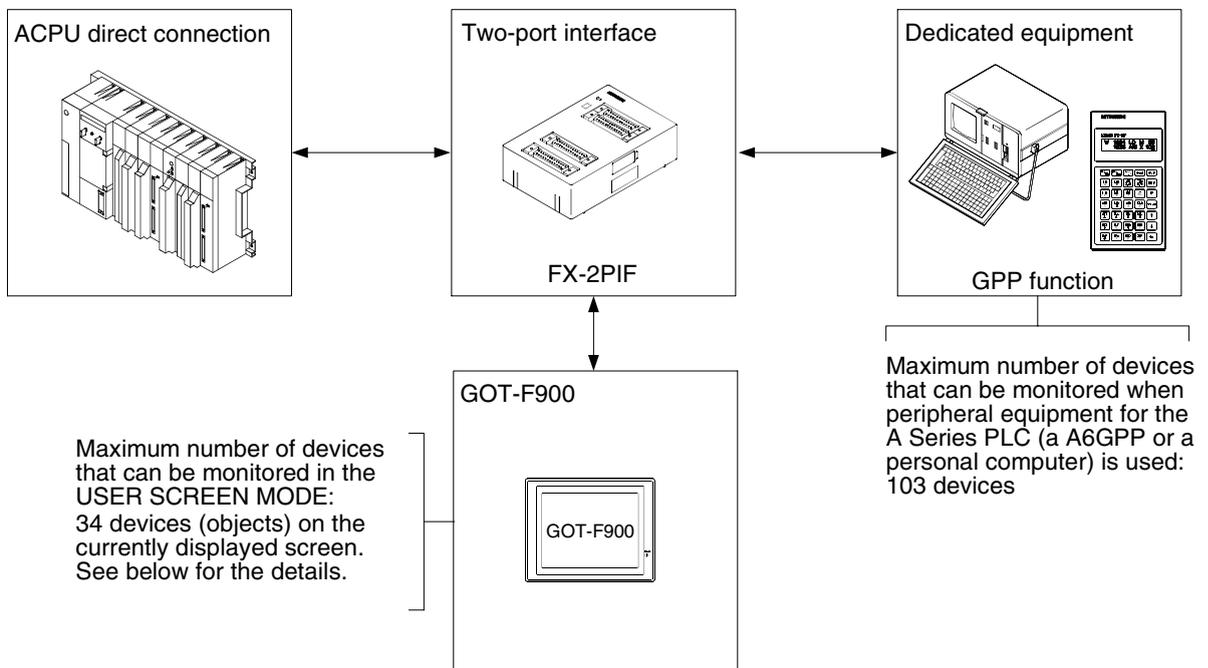

#### 3) Calculation of active devices at one time (when the A Series PLC is connected)

The number of devices, "Number (Numerical Display), Bar Graph, Indicator (Lamp), Change Screen (Display screen changeover)", in the USER SCREEN MODE is calculated using the following formula. Have in mind, however, the number of devices being monitored varies depending on the setting of the bar code reader, printer connection and GOT system in the screen creation software.

$$\text{Common screen} + \text{Base screen} + \frac{\text{Overlap window 1} + \text{Overlap window 2}}{\text{(Overlapped screens)}} \leq 34$$

The total sum of devices from the Common screen (only in the DU/WIN software) and each of the screens is calculated while referring to the table on the next page, and should be within the range shown above. Correct monitoring cannot be executed if too many devices are connected.

Connected PLC: AnA		Connected PLC: AnN, A2C, A1S, A0J2H	
Object	Number of objects used	Object	Number of objects used
Number (Numerical Display), Bar Graph: 16 bits	2	Number (Numerical Display), Bar Graph: 16 bits	2
Number (Numerical Display), Bar Graph: 32 bits	4	Number (Numerical Display), Bar Graph: 32 bits	4
Indicator (Lamp)	1	Indicator (Lamp)	
		Device settings: other than "Input X"	1
		Device settings: "Input X"	2
Change Screen (Display screen changeover) using device conditions	1	Change Screen (Display screen changeover)	
		Device settings: other than "Input X"	1
		Device settings: "Input X"	2

- The current value and indirectly specified value set by the Number (Numerical Display) and Bar Graph is counted.  
The device conditions used in the Change screen (Display screen changeover) setting is counted.
- When performing the screen display or screen overlap, make sure the total number of devices on displayed screens does not exceed the total in the previous formula (34).

**4) Restriction in PLC current consumption**

The FX-2PIF current consumption is shown in the following table. The power is supplied from the 5V DC power supply of the PLC.

For the 5V DC power capacity, refer to the PLC manual.

Item	Specification
Line voltage	5V DC (supplied from the PLC)
Current consumption	310mA (when a personal computer PC9801 or PC/AT compatible model is used.) 340mA (when FX-20P is used.) 180mA (when A7PHP, A7HGP, A6GPP, A6PHP, A6HGP and MELSEC-LM is used.)

### 23.3.3 Switch Setting in FX-2PIF

Perform the following switch settings in accordance with the connected MELSEC-F/A Series PLC or peripheral equipment.

For the details, refer to the FX-2PIF USER'S GUIDE (JY992D38501).

#### 1) Peripheral equipment selection switch

<u>Peripheral equipment selection switch</u> (Underline indicates setting at shipment)	Peripheral equipment for GPP
GPP/HPP side	A7PHP/HGP A6GPP/PHP/HGP
COMPUTER side	Personal computer (PC-9800, PC/AT compatible equipment) Dedicated peripheral equipment (MELSEC-LM Series)

#### 2) PLC selection DIP switches

PLC selection DIP switches				Applicable PLC
Number 1	Number 2	Number 3	Number 4	
OFF	OFF	OFF	OFF	FX Series PLC except FX2N Series
OFF	ON	OFF	OFF	FX2N Series PLC (FX-2PIF version 3.00 or later)
ON	OFF	OFF	OFF	A Series PLC except AnU Series
ON	ON	OFF	OFF	AnU Series PLC

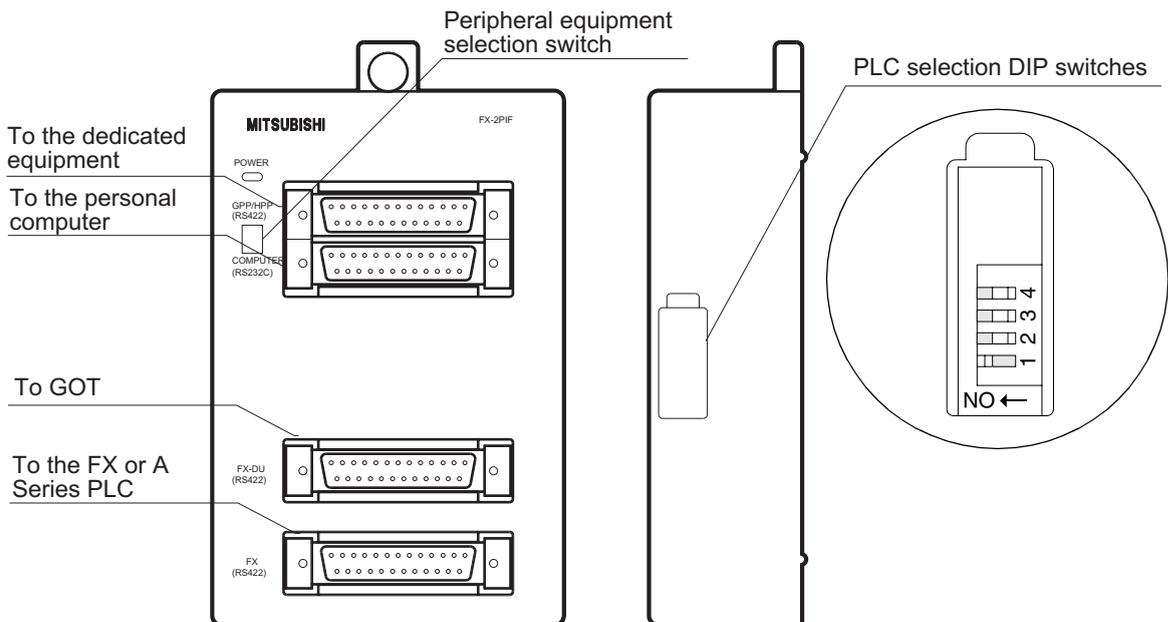

To make the change in switch setting valid, the power must be turned off and then turned on again.

### 23.3.4 Cautions on Use of FX-2PIF

When using the FX-2PIF connected to the GOT-F900 for monitoring, observe the following cautions on use.

#### 1) Access to PLC CPU through FX-2PIF

- a) The access from the dedicated equipment (GPP function) or GOT is enabled only when the PLC is connected with the FX-2PIF.

Because of the restriction in communication time, access to another MELSECNET PLC station is not possible. A communication error (time out error) will occur.

Example: IF a GOT tries to access a different PLC station, an error occurs in the communication between the dedicated equipment (GPP function) and the PLC.

- b) When using FX-2PIF, the response speed from the PLC CPU to the GOT or dedicated equipment (GPP function) is approximately four or five times slower than when it is not used. The same situation exists when either the GOT or dedicated equipment (GPP function) is connected to the FX-2PIF.

#### 2) Operation of dedicated equipment (GPP function) through FX-2PIF

- a) The circuit monitor by the GPP function is available to monitor 103 points (\*1).

\*1 Includes the monitor points of RUN/STOP status of the PLC and scan time counted by the special data register. An error will not occur even though the number of devices being monitored exceeds 103, however, the extra devices are not monitored correctly.

- b) While the GPP function is being used for monitoring timer/counter settings of the PLC CPU, it displays the original set value even after a change is made by the GOT. In such a case, the program should be read from the PLC CPU so that the latest set value is displayed. The display of the set value in the PLC CPU and the GOT is changed if any setting change is made using the GOT.

**23.3.5 Cautions on preparing cables**

When preparing the cables, use the wire size of 0.08mm<sup>2</sup> or more (AWG28 or more) for communication, 0.3mm<sup>2</sup> or more (AWG22 or more) for the power supply, operation switch, and emergency stop switch. Do not use a twisted pair cable for the power supply wire and the communication wire.

**23.3.6 Cable Diagram**

**1) Cable for the GOT and the FX-2PIF**

 : Female type  : Male type The figure shows the connector type.

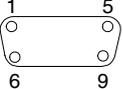
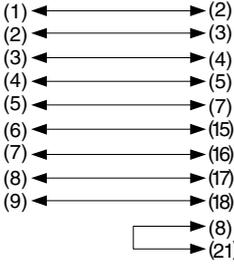
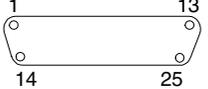
No.	Model name	Application	Connection diagram	Application
a)	<div style="border: 1px solid black; padding: 2px; display: inline-block;">RS-422 connection</div> FX CPU direct connection FX-40DU-CAB FX-40DU-CAB-10M FX-40DU-CAB-20M FX-40DU-CAB-30M FX-50DU-CABL	To GOT-F900   9-pin D-Sub, male		To FX/FX1/FX2c   25-pin D-Sub, male

**2) Cable for the FX-2PIF and PLC**

 : Female type  : Male type The figure shows the connector type.

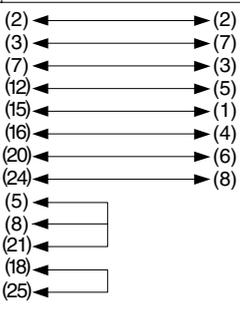
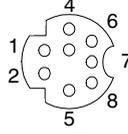
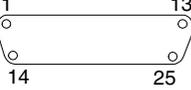
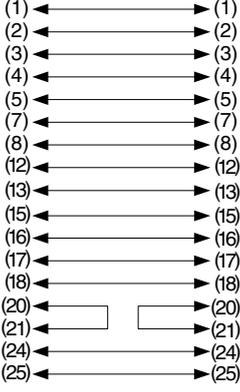
No.	Model name	Application	Connection diagram	Application
a)	<div style="border: 1px solid black; padding: 2px; display: inline-block;">RS-422 connection</div> FX-422CAB0	To FX-232AW(C)   25-pin D-Sub, male		To FX0/FX0s/FX1s/FX0N/ FX1N/FX2N/FX2NC   8-pin MINI DIN, male
b)	<div style="border: 1px solid black; padding: 2px; display: inline-block;">RS-422 connection</div> FX-422CAB	To FX-232AW(C)   25-pin D-Sub, male		To FX/FX1/FX2c/ A/QnA   25-pin D-Sub, male



### 23.4 GOT-F900 Connector Signal Correspondence Table (Excluding the 5V type F920GOT-K.)

#### 23.4.1 RS-422 Correspondence Table

The connector figure shows the engagement face of the connectors on both ends of cable.

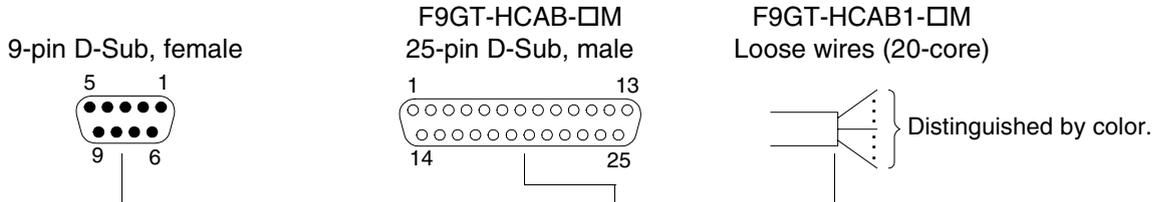

F930GOT(-K),F940GOT,F940WGOT		Handy GOT		
Pin number of D-Sub port on rear face	RS-422 signal name	F9GT-HCAB-□M	F9GT-HCAB1-□M	RS-422 signal name
		Pin number	Loose wire color	
1	TXD+(SDA)	2	Black	TXD+(SDA)
2	RXD+(RDA)	6	Yellow	RXD+(RDA)
3	RTS+(RSA)	4	Red	RTS+(RSA)
4	CTS+(CSA)	8	Blue	CTS+(CSA)
5	SG(GND)	10	Orange	SG(GND)
6	TXD-(SDB)	3	White	TXD-(SDB)
7	RXD-(RDB)	7	Brown	RXD-(RDB)
8	RTS-(RSB)	5	Green	RTS-(RSB)
9	CTS-(CSB)	9	Gray	CTS-(CSB)
-	-	1	Drain wire	FG (shield)

#### 23.4.2 RS-232C Correspondence Table

The connector figure shows the engagement face of the connectors on both ends of cable.

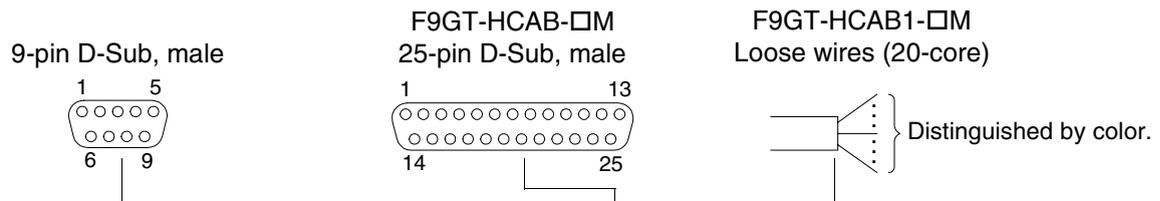

F930GOT(-K),F940GOT,F940WGOT		Handy GOT		
Pin number of D-Sub port on rear face	RS-232C signal name	F9GT-HCAB-□M	F9GT-HCAB1-□M	RS-232C signal name
		Pin number	Loose wire color	
1	NC	8	Blue	NC
2	RD(RXD)	4	Red	RD(RXD)
3	SD(TXD)	2	Black	SD(TXD)
4	ER(DTR)	3	White	ER(DTR)
5	SG(GND)	10	Orange	SG(GND)
6	DR(DSR)	5	Green	DR(DSR)
7	RS(RTS)	6	Yellow	RS(RTS)
8	CS(CTS)	7	Brown	CS(CTS)
9	User cannot use	9	Gray	NC
-	-	1	Drain wire	FG (shield)

## 23.5 Error Messages in GOT-F900 Series

The table below shows Japanese and English messages displayed when the GOT-F900 is connected to the PLC, bar code reader or printer. Refer to the countermeasures on the next page.  
The error messages have been changed for greater clarity in later versions of the OS.

No.	Japanese message	English message	OS version of GOT-F900		
			F940WGOT	F940GOT	F930GOT(-K)
1	通信エラーが発生しました	COMMUNICATION ERROR OCCURS.	From first product	From first product	From first product
2	該当する画面がありません	DISPLAY SCREEN IS NOT AVAILABLE.	-	Earlier than 6.00	Earlier than 4.00
	次の画面がありません (NO. #####)	DISPLAY SCREEN IS NOT AVAILABLE.(NO.#####)	From first product	6.00 or later	4.00 or later
3	該当する画面にエラーがあります	DISPLAY SCREEN IS NOT AVAILABLE.	-	Earlier than 6.00	Earlier than 4.00
	次の画面にエラーがあります (NO. #####)	DISPLAY SCREEN IS NOT AVAILABLE.(NO.#####)	From first product	6.00 or later	4.00 or later
4	データがありません	DATA IS NOT FOUND.	-	Earlier than 6.00	Earlier than 4.00
			From first product	6.00 or later	4.00 or later

"###" in the table above indicates the screen number in which the error has occurred.

The messages and countermeasures for the F920GOT-K may be slightly different.

F920GOT-K		Countermeasures
From first product		<ul style="list-style-type: none"> <li>• The power of the connected equipment is turned off. → Confirm the power supply voltage.</li> <li>• The wiring between the connected equipment (PLC) is not correct. → Refer to the appropriate wiring section.</li> <li>• In connection of two or more GOT units, the opening screen display period in the second and later GOT units is not long enough. → Refer to the description on connection of two or more GOT units.</li> <li>• The power of the GOT is turned on before the PLC. → Make sure that communication with the connected equipment is ready before display of the opening screen of the GOT is finished.</li> </ul>
-		<ul style="list-style-type: none"> <li>• Changeover to a nonexistent (uncreated) screen. → By selecting "SELECT MODE"- "TEST MODE"- "USER SCREEN", check whether the screen data to be displayed exists.</li> </ul>
From first product		<ul style="list-style-type: none"> <li>• A nonexistent screen was to be displayed. → Make sure that the screen No. #### has been created.</li> </ul>
-		<ul style="list-style-type: none"> <li>• There is an error on the changeover destination screen. → By selecting "SELECT MODE"- "TEST MODE", check whether the changeover destination screen is free from error and displayed correctly. If there is an error, "x" is displayed at the head of the list on the screen.</li> </ul>
From first product		<ul style="list-style-type: none"> <li>• There is an error on the screen to be displayed. → By selecting "SELECT MODE"- "TEST MODE" in the GOT, check whether the screen is displayed correctly. If there is an error, "x" is displayed at the head of the list on the screen.</li> </ul>
-		<ul style="list-style-type: none"> <li>• The GOT-F900 is in the factory default settings and no screen data is available. → Write the screen data using the screen creation software.</li> <li>• The memory of the GOT-F900 is cleared. → Write the screen data using the screen creation software.</li> <li>• The head screen has not been created. → The head screen is the screen number 1 in the GT Designer, and the screen number 0 in the DU/WIN. The head screen is essential and must be created.</li> <li>• There is an error on the head screen. → By selecting "SELECT MODE"- "TEST MODE", check whether the changeover destination screen is free from error and displayed correctly. If there is an error, "x" is displayed at the head of the list on the screen.</li> </ul>
From first product		<ul style="list-style-type: none"> <li>• The GOT-F900 is in the status at shipment from the factory, and no screen data is written. → Write the screen data using the screen creation software.</li> <li>• The memory of the GOT-F900 is cleared. → Write the screen data using the screen creation software.</li> </ul>

If the screen with "x" in the list of "TEST MODE" is tried to be displayed, the message "BAD OBJECT EXISTS" is displayed.

## 23.5.1 Error Messages During Screen Operation

No.	Japanese message	English message	OS version of GOT-F900		
			F940WGOT	F940GOT	F930GOT(-K)
1	PCメモリが書き込み禁止です	CAN NOT WRITE TO PLC MEMORY.	Earlier than 1.10	Earlier than 6.10	Earlier than 4.10
	書き込み禁止です	CAN NOT WRITE.	1.10 or later	6.10 or later	4.10 or later
2	キーワードがあるのでその操作はできません	CAN NOT USE THE FUNCTION WHILE PROTECTED.	From first product	From first product	From first product
3	PCがRUN中です	PLC IS RUNNING.	From first product	From first product	From first product

		Countermeasures
	F920GOT-K	
	-	<ul style="list-style-type: none"> <li>The protect switch of the memory cassette is ON. → Set the protect switch to OFF.</li> <li>In the program of the FX Series PLC, passwords are used and write is disabled. → By selecting "SELECT MODE"- "OTHER MODE"- "ENTRY CODE" in the GOT, release the passwords.</li> </ul>
	From first product	<ul style="list-style-type: none"> <li>The protect switch of the memory cassette is ON. → Set the protect switch to OFF.</li> <li>In the program of the FX Series PLC, passwords are registered and write is disabled. → By selecting "SELECT MODE"- "OTHER MODE"- "ENTRY CODE" in the GOT, release the passwords.</li> <li>While the inverter was not in the computer link operation mode or while the inverter was running, parameter (Pr) to communication was attempted. → In the manual of the inverter, check the allowable write range in operation mode.</li> </ul>
	From first product	<ul style="list-style-type: none"> <li>In the program of the FX Series PLC, passwords are registered and write is disabled. By selecting "SELECT MODE"- "OTHER MODE"- "ENTRY CODE" in the GOT, release the passwords.</li> </ul>
	From first product	<ul style="list-style-type: none"> <li>While the FX Series PLC was running with the EEPROM memory cassette, the set value of the timer, counter or the file register was attempted to be changed from the screen of the GOT-F900. → Specify the set value of the timer or the counter indirectly using the data register (D) or run the PLC with the built-in memory.</li> </ul>

# MEMO



# HARDWARE MANUAL [CONNECTION]

GOT-F900 SERIES GRAPHIC OPERATION TERMINAL



HEAD OFFICE : TOKYO BUILDING, 2-7-3 MARUNOUCHI, CHIYODA-KU, TOKYO 100-8310, JAPAN  
HIMEJI WORKS : 840, CHIYODA CHO, HIMEJI, JAPAN

MODEL	GOTF900-HW-SE-E
MODEL CODE	09R805

JY992D94801F  
(MEE)

Effective Sep. 2008  
Specification are subject to change without notice.